

**SIEMENS**

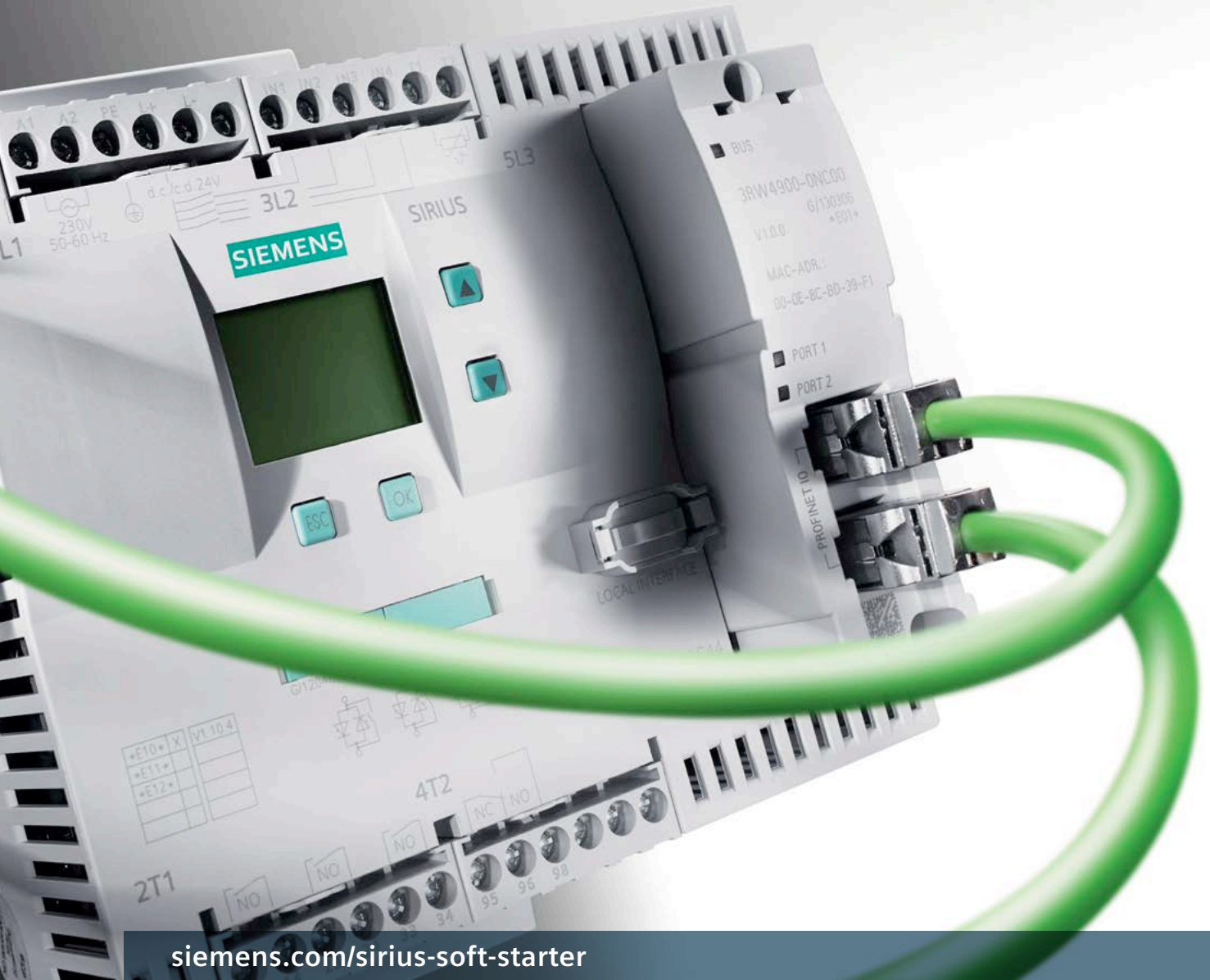

[siemens.com/sirius-soft-starter](http://siemens.com/sirius-soft-starter)

# SIRIUS Soft Starters

Protection of motors and mechanics, reduced load on the mains

Answers for industry.

# The Ideal SIRIUS Soft Starter for All Applications

Today, three-phase motors serve as the ultimate drive concept. Yet, for many cases, direct starting or wye-delta starting may not always be the best solution. Annoying side effects such as mechanical impact in the machine or voltage drops in the line supply frequently occur. With SIRIUS soft starters, these problems are a thing of the past. This seamless range offers a suitable soft alternative for almost any application – whether for standard or high-feature starting. Optimum and future-proof machine concepts can be very easily and efficiently realized through the smooth starting of three-phase motors.



<b>SIRIUS Devices for the Control Cabinet</b>	4
<b>Soft Starting of Three-Phase Motors</b>	5
<b>Technology in Detail</b> The Soft Principle	6
<b>Soft Starters for Standard Applications</b> SIRIUS 3RW30 and 3RW40	8
<b>Conversion Made Easy</b> SIRIUS 3RW30 in Detail	10
<b>High Functionality for Minimum Costs</b> SIRIUS 3RW40 in Detail	12
<b>Soft Starters for High-Feature Applications</b> SIRIUS 3RW44 in Detail	14
<b>Soft Starter ES</b> Comfortable Parameterization and Evaluation of SIRIUS 3RW44	16
<b>Block Library SIRIUS 3RW44 for SIMATIC PCS 7</b> Parameterization, configuration and visualization of SIRIUS 3RW44	18
<b>SIRIUS Soft Starters in Practical Use</b> Application Examples	20
<b>Overview of SIRIUS Soft Starters</b> Technical Data	22
<b>Effective Selection of SIRIUS Soft Starters</b>	23

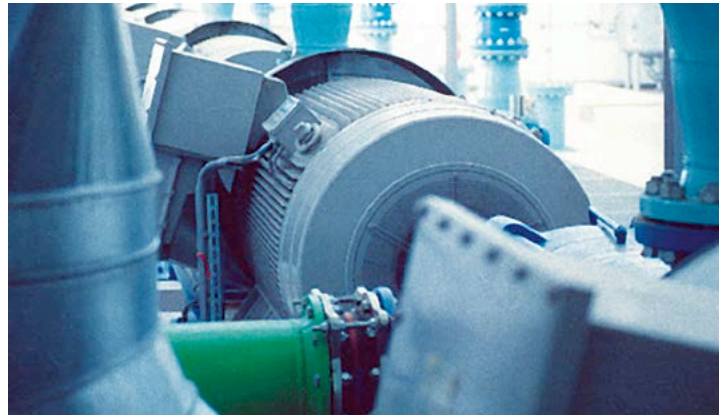

With SIRIUS soft starters, e.g. the acceleration of cooling water pumps in power plants can be optimized and water hammers avoided through special pump stop functions.



# SIRIUS Devices for the Control Cabinet

SIRIUS soft starters are perfectly matched with the SIRIUS devices for the control cabinet. The modular standard components, which can be flexibly combined, offer everything for the switching, protecting and starting of various consumers. The range features state-of-the-art technology and offers continuous innovations such as compact soft starter solutions, solid-state switching devices and many further products.

With only seven sizes, the range covers the entire power spectrum up to 250 kW. To assemble a load feeder in next to no time, a soft starter, circuit breaker, contactor or overload relay is simply docked on and screw-fastened. By the way, also maintenance is just as easy and fast as the SIRIUS components' configuration, installation and wiring.

SIRIUS devices for the control cabinet not only feature innovative technology, but are also accommodated in a perfect design, which received the renowned iF Product Design Award. Space-saving assembly, outstanding ergonomics as well as excellent design and workmanship ensure a particularly tidy arrangement in the control cabinet.

SIRIUS also scores a top ranking in worldwide comparison: Whether in São Paolo, Berlin or Shanghai – SIRIUS devices for the control cabinet are available with international approvals all around the world. Our comprehensive service network provides prompt support throughout the entire life cycle in more than 190 countries.

The SIRIUS range	
<b>Load feeders</b>	Up to 250 kW easily realizable with standard devices
<b>Modularity</b>	Everything is matched and can be combined as required
<b>Versions and sizes</b>	Efficient and flexible, thanks to 7 compact sizes
<b>Assembly</b>	Fast commissioning, short set-up times, easy wiring
<b>Communication</b>	Open for SIRIUS NET; connection to AS-Interface, PROFINET and PROFIBUS DP possible
<b>Maintenance</b>	Extremely durable; low maintenance and reliable
<b>Construction</b>	Space-saving, thanks to small device width and side-by-side assembly up to 60 °C
<b>Approvals</b>	Worldwide approvals and certification UL, CSA, shipbuilding
<b>Design</b>	Clear, ergonomic and award-winning
<b>Mounting</b>	Reliable screw-type or snap-on mounting over entire service life
<b>Service</b>	Short delivery periods also for spare parts through global logistics network
<b>Environment</b>	Environmentally friendly production and materials; recyclability; low power loss
<b>Accessories</b>	Low variance with integrated accessories
<b>Spring-loaded technology</b>	Fast and safe connection; vibration-proof and maintenance-free



# Soft Starting of Three-Phase Motors

## SIRIUS soft starters – advantages at a glance

- Soft start and soft stop
- Smooth starting, without steps
- Reduced current peaks
- Avoidance of line voltage fluctuations during start-up
- Reduced load on the power supply system
- Reduced mechanical load in the drive
- Considerable space savings and reduced wiring compared to other starters
- Maintenance-free switching
- Ease of handling
- Perfectly matched with SIRIUS devices for the control cabinet



## What is the operating principle of soft starters?

Soft starters limit the starting current and starting torque. This reliably prevents both mechanical stress as well as line voltage dips. The motor voltage is reduced through phase angle control and increased from an adjustable starting voltage up to the line voltage within the ramp time. Thanks to the step-free control of the supply voltage, the motor is adjusted to the driven machine's load behavior. Mechanical operating equipment is accelerated in a particularly gentle manner, which positively influences its operating behavior and prolongs its service life.

In short: Soft starting and stopping protects the connected devices and ensures a smooth production flow.

## Can load feeders be assembled with soft starters?

Of course. Fuseless load feeders of small size can be effortlessly assembled with circuit breakers, e.g. the SIRIUS 3RV. Thanks to the integrated overload functionality, also fused feeders can be realized<sup>1)</sup> in a rapid and space-saving manner.

## How is the connection realized?

Connection is realized in the same manner as with all other SIRIUS devices for the control cabinet: either using screw-type or spring-loaded terminals. Further connection systems can be employed subject to availability.

## What about communication?

As a matter of course, our soft starters are able to communicate with the outside world. With our high-feature soft starters, this is realized with communication modules for PROFIBUS DP and PROFINET.

<sup>1)</sup> Not with 3RW30

# Technology in Detail

## The Soft Principle

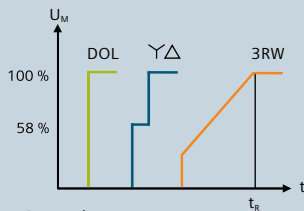

DOL: Direct start  
 $\Upsilon\Delta$ : Wye-delta start  
 3RW: Soft start  
 $U_M$ : Motor voltage  
 $I_M$ : Motor current  
 $M_M$ : Motor torque  
 $t$ : Time  
 $t_R$ : Ramp time  
 $n$ : Speed  
 $N$ : Rated values

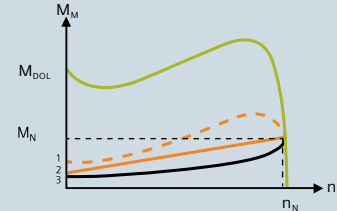
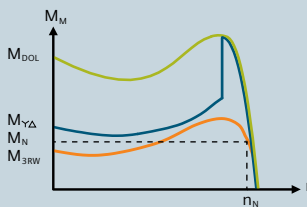
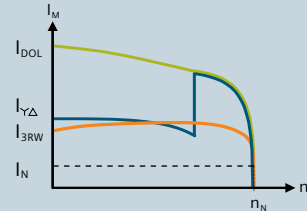

1  $M_{3RW}$   
 with voltage ramp  
 2  $M_{3RW}$   
 with torque control  
 3  $M_L$   
 Load (e.g. pump)

Different starter types in comparison: Direct start, wye-delta start and soft start

Torque control prevents abrupt fluctuations

### How are the parameters of a soft starter set?

With our standard soft starters, the ramp-up time, starting voltage and ramp-down time can be comfortably set via potentiometers. The values can be adjusted particularly finely within the usual setting ranges. For soft starters with motor overload protection, this also applies to the nominal motor current, the selection of the tripping class and the settable current limiting. The multiple functions of our high-feature soft starters are set rapidly and comfortably via the integrated keypad with menu-prompted graphical display. Also commissioning and diagnostics are realized via this keypad.

### Why is torque control the better solution?

Current and voltage fluctuations upon start-up are problems frequently encountered by operators of power supply systems. Your machines are then stressed by abrupt torque fluctuations. The soft torque control of our high-feature soft starters minimizes the maintenance expenditures for your machines.

### How about motor overload protection?

No problem: Our soft starters come with integrated motor overload protection for many applications. This does away with additional wiring costs and even protects the soft starter against overload. For all other cases, you can utilize the advantages of our further SIRIUS devices for the control cabinet by employing our circuit breakers or overload relays. All components are perfectly matched.

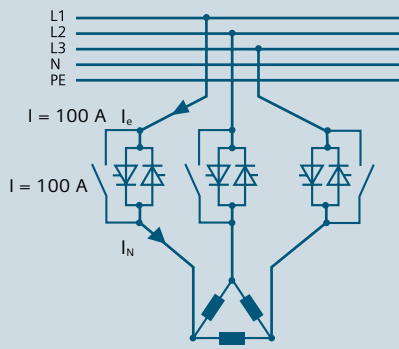

Rated current  $I_e$  of the starter corresponds to the nominal motor current  $I_N$   
3 cables to the motor

Standard circuit

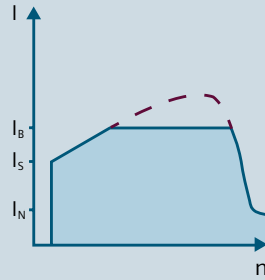
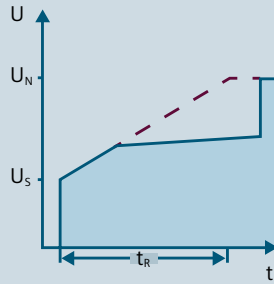

— with current limiting  
- - - with voltage ramp

$U_s$ : Starting voltage  
 $I_s$ : Starting current  
 $I_b$ : Limiting current

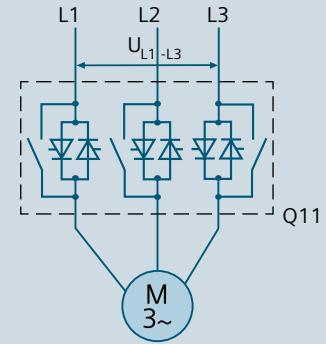

Rated current  $I_e$  of the starter corresponds to 58% of the nominal motor current  $I_N$   
6 cables (as with wye-delta starters) to the motor

Inside-delta circuit

Soft start-up with voltage ramp and current limiting

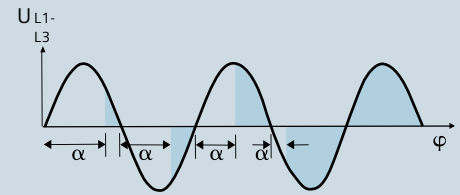

$\alpha$  = Phase control angle

Phase control angle principle of the line voltage with soft starters using semiconductor elements

### What are the advantages of the inside-delta circuit?

With inside-delta circuits, the soft starter's phases are switched in series with the individual motor windings, thanks to which the soft starter merely has to conduct the delta current, i. e. 58% of the nominal motor current (conductor current). Automatic recognition of the circuit type by our soft starters partially facilitates the application of considerably smaller devices.

### Do all three phases have to be controlled?

No, this is not required for operational switching. Also for smooth motor start using our soft alternative, two controlled phases are sufficient with standard soft starters. Moreover, our solution not only saves costs, but also space in the control cabinet. However, the third controlled phase is required for inside-delta circuits.

### What are the benefits of settable current limiting?

More and more power supply companies request compliance with specific current limit values during start-up to minimize the load on the power supply systems posed by high starting currents. This requirement can be perfectly met with the settable current limiting of our soft starters.

### Is an external bypass contactor required?

No. Thanks to integrated bridging contact systems, bypass contactors are unnecessary while the power semiconductors' power loss is nevertheless sustainably minimized.

### Are there further options for soft motor starting?

Soft motor starting can also be realized with a frequency converter. However, this is only reasonable if the motor's speed is to be influenced also during operation in addition to the starting phase – which increases the costs.

# Soft Starters for Standard Applications

## SIRIUS 3RW30 and 3RW40

Thanks to their compact design, integrated motor overload and intrinsic device protection, settable current limiting and further features, SIRIUS soft starters are the ideal starter solution for all kinds of standard applications.

In the past, typical starter solutions for standard applications were based on direct and wye-delta starting. Today, the advantages offered by soft starter solutions are increasingly utilized. SIRIUS soft starters, for example, not only improve the start-up behavior of escalators, elevators, conveyor belts and pumps, as they simply facilitate a softer start-up than electromechanical starters. Above all, they protect the drive system and the mains supply and thus contribute to reducing the system costs from many points of view.

To allow for an optimum adjustment of your drive to the application, we offer a complete portfolio of soft starters in various sizes for almost any application area. For example, the two-phase-controlled SIRIUS 3RW30 is particularly suitable for standard applications up to 55 kW. SIRIUS 3RW40, which additionally offers motor overload, intrinsic device and thermistor motor protection, also masters demanding tasks in a soft manner within the power range from 5.5 to 250 kW.







# Conversion Made Easy

## SIRIUS 3RW30 in Detail

Belt slippage with heater blowers or sudden water pressure build-up in washing systems are only two of many possible problems which may occur if motors output too much power directly upon start-up.

With the SIRIUS 3RW30, such failures are reliably prevented up to 55 kW (with 400 V). The main advantage:

As the SIRIUS 3RW30 is the world's only soft starter which offers identical sizes within one device range, it even allows for a direct conversion from direct to soft starting.

### What are the advantages of soft starting?

The advantages are multiple, as the SIRIUS 3RW30 reduces the stress on the motor by reducing the start-up torque and protects the mains against hazardous current peaks through reduced current input. This reliably eliminates line voltage dips.

### What are the benefits of the SIRIUS 3RW30?

The SIRIUS 3RW30 is particularly compact thanks to its consistently optimized power components in hybrid technology. It thus also facilitates side-by-side assembly up to 60 °C. It offers fast configuration and easy mounting with only 3 motor supply cables. Small fuseless load feeders

can be assembled with a single module – with the SIRIUS 3RV circuit breaker. Also fused feeders can be realized in a fast and space-saving manner in combination with SIRIUS 3RB solid-state overload relays.

### What about safety and reliability?

Thanks to two-phase control and the patented “polarity balancing” control principle, the SIRIUS 3RW30 is a dependable device which ensures safe and reliable operation. In addition, the integrated bypass contact system reduces the soft starter's heat loss during operation.



### What are the application areas?

The SIRIUS 3RW30 can be employed in almost any standard application up to a motor rating of 55 kW with 400 V. For example for driving conveyor belts, compressors, grinding machines, saws, agitators, etc.

### How is the SIRIUS 3RW30 set?

Ramp-up time and starting voltage can be comfortably and easily set via 2 potentiometers, ensuring optimum starting behavior.

### How is the soft starter controlled?

Without interface relays, the SIRIUS 3RW30 can be directly controlled via the PLC – or via the control input. The respective operating state is signaled via a relay output.

### What are the saving potentials?

Space savings in the control cabinet up to 70% are achievable compared to wye-delta starters (example 18.5 kW: 45 mm width instead of 158 mm). The SIRIUS 3RW30 also pays off in terms of mounting: with only 3 instead of 6 motor supply cables.

The 3RW30 is also available with removable control terminals. When replacing a 3RW30, the wiring on the terminal thus remains intact (“permanent wiring”) and the terminals are simply snapped onto the new 3RW30, which saves a considerable amount of time.

### Is the SIRIUS 3RW30 affordable?

Absolutely, as it not only ensures reliable operation thanks to standardized production, but is also very attractive in terms of price.

### How about accessories?

In addition to easy-to-mount terminal covers for optimum touch protection, also box terminal blocks, connection modules and labeling strips from the SIRIUS range are available for the 3RW30.



With the SIRIUS 3RW30 in size S0 (45 mm), up to 38 A can be switched

# High Functionality for Minimum Costs

## SIRIUS 3RW40 in Detail

The SIRIUS 3RW40 is the top star among all standard soft starters! Thanks to its innovative control principle, it is not only the world's only two-phase-controlled soft starter in the power range from 5.5 kW (with 400 V) to 250 kW (with 400 V), but is also the smallest available solution thanks to its particularly compact design. It facilitates space-saving and transparent control cabinet arrangements and is thus more than a supplement of our two-phase-controlled SIRIUS 3RW30 soft starter range.

### What are the benefits of the SIRIUS 3RW40?

The SIRIUS 3RW40 soft starter is seamlessly integrated in our SIRIUS portfolio for the control cabinet. As you might already know from experience with other SIRIUS devices, you will thus benefit from identical sizes and uniform connection systems. Regarding size: the particularly compact design of the SIRIUS 3RW40 is at most half as big as that of a comparable wye-delta starter, making space wastage in the control cabinet a thing of the past.

Also configuration and mounting are realized rapidly and easily thanks to 3-conductor connection.

### What are the differences compared to the SIRIUS 3RW30?

In general, the SIRIUS 3RW40 offers all the advantages of the 3RW30. In addition, it offers intrinsic device protection and integrated motor protection functions. Just test it and you will be convinced.

### How is the SIRIUS 3RW40 set?

Like with the SIRIUS 3RW30, the starting voltage, ramp-up and ramp-down time of the voltage ramp, as well as the current limiting, can be comfortably set via finely adjustable rotary potentiometers. The nominal motor current, trip class and reset of the motor overload function are adjusted via potentiometers and buttons, as is familiar from the SIRIUS overload relays.

### What are its outstanding characteristics?

The SIRIUS 3RW40 comes with the new patented control principle "polarity balancing" for the avoidance of DC components in two-phase-controlled soft starters. With two-phase-controlled soft starters, the current resulting from the overlapping of the two controlled phases flows in the uncontrolled phase. For physical reasons, this results in an asymmetric distribution of the three phase currents during the motor's start-up process.



Even though this distribution cannot be influenced, it is uncritical in most applications. However, besides this asymmetry, the power semiconductors' control during the two controlled phases also produces the above-mentioned DC components, which may lead to a loud motor noise with starting voltages lower than 50%. "Polarity balancing" reliably eliminates these DC components during the start-up phase. It generates an even motor start-up in terms of speed, torque and current rise. The acoustic quality of the start-up process almost reaches the quality of a three-phase-controlled start-up. This is made possible by the continuous dynamic alignment and balancing of current half-waves with different polarity during the motor start-up.

**Does the SIRIUS 3RW40 feature additional protective functions?**

The SIRIUS 3RW40 is equipped with optimum functionality as standard. An integrated bypass contact system reduces the soft starter's heat loss during operation. This reliably prevents heating of the switching device's environment. The integrated motor overload protection in accordance with IEC 60 947-4-2 makes an additional overload relay unnecessary; this saves space in the control cabinet and reduces the wiring costs in the feeder. The overload trip class can be variably set via a 4-level rotary potentiometer. In addition, intrinsic device protection prevents the thyristors' thermally overloading and resulting defects of the power components. Optionally, the thyristors can also be protected against short circuit with SITOR semiconductor fuses. Also inrush current peaks are reliably eliminated, thanks to settable current limiting.

**Does the SIRIUS 3RW40 offer diagnostics options?**

Yes, thanks to integrated status and fault monitoring. LEDs provide information on the operating state as well as possible faults, e.g. impermissible release time (CLASS setting), mains or phase failure, missing load, thermal overload or device fault. The two integrated output relays also indicate the operating state and fault signals.

**Is thermistor motor protection available?**

Device versions with thermistor motor protection evaluation are available up to a rating of 55 kW (with 400 V). A "Thermoclick" measuring sensor or PTC (type A) can be directly connected. In addition to thermal motor overload, wire breakage and short circuit in the sensor circuit effect a disconnection of the soft starter.

**What about reset options?**

After the soft starter has tripped, various reset options are available, like for intrinsic device and motor overload protection: manual or via the reset button, automatic or (up to 55 kW) remotely via short-term control voltage interruption.

**Is replacement easy?**

Yes, also the 3RW40 is equipped with removable control terminals. The wiring on the terminal thus remains intact ("permanent wiring") in case of replacement and the terminals are simply snapped onto the new 3RW40, which saves a considerable amount of time.

**How about accessories?**

We offer a comprehensive range of accessories for our soft starters, e.g. box terminal blocks, accessories for mechanical reset and a module for remote reset (for ratings > 75 kW) as well as a sealing cover and easy-to-mount terminal covers for optimum touch protection.

Furthermore, snap-on fans are available for the devices up to 55 kW which facilitate mounting of the SIRIUS 3RW40 in almost any installation position and support higher switching duties. In addition, connection modules for electrical and mechanical connections between circuit breaker and soft starter as well as labeling strips from the SIRIUS range are available.



Easy setting via invariably adjustable rotary potentiometers



Integrated state and fault monitoring via LEDs

# Soft Starters for High-Feature Applications

## SIRIUS 3RW44 in Detail

Equipped with maximum functionality, the all-round talent SIRIUS 3RW44 even masters difficult start-up and stopping processes in a soft manner. Thanks to innovative torque control, it can be employed for drives up to a power rating of 710 kW (with 400 V) in standard circuit or up to 1200 kW in inside-delta circuit. The functionality designed for ease of operation facilitates optimum operating comfort.

### What are the benefits of the SIRIUS 3RW44?

Thanks to its particularly compact design, which is a characteristic of the entire range of SIRIUS soft starters, the SIRIUS 3RW44 is the ideal solution when space-saving and transparent control cabinet arrangements are required. For optimized motor start-up and stopping, the innovative SIRIUS 3RW44 offers an attractive and efficient alternative to frequency converters. The new torque control and a settable current limiting allow for the use of our high-feature soft starters in almost any application. The SIRIUS 3RW44 guarantees reliable prevention of torque surges and current peaks during motor starting and stopping. This reduces costs both for switchboard dimensioning as well as machinery maintenance.

Whether for standard (in-line) or inside-delta circuits – the SIRIUS 3RW44 offers saving potentials, particularly in terms of size and device costs.

### How is the SIRIUS 3RW44 commissioned and operated?

Commissioning of the SIRIUS 3RW44 is particularly fast and easy, thanks to a modern and ergonomic menu system. This is facilitated by a keypad with a menu-driven, multi-line graphical display with background illumination. The optimized motor start-up and stopping can be realized rapidly, easily and safely via only few settings in several preselected languages. 4-key operation and plain text displays on every menu item ensure transparent parameterization and operation at all times. Via the display field, measuring and operating values, as well as warning and fault messages, are continuously displayed during operation and with the control voltage connected. In addition, an external display and operator module can be connected to the soft starter via a connection cable, for example to read actual values directly from the control cabinet door.



### Does the SIRIUS 3RW44 feature additional protective functions?

The SIRIUS 3RW44 is equipped with optimum functionality as standard. An integrated bypass contact system reduces the soft starter's heat loss during operation. This reliably prevents heating of the switching device's environment. Moreover, it features an internal device overload protection against thermal overload of the power section's thyristors, e.g. caused by impermissibly high starting operations.

The wiring costs for installation of an additional motor overload relay are eliminated as the SIRIUS 3RW44 also masters this function. Whether settable release times or thermistor motor protection: With SIRIUS 3RW44, you are always on the safe side! Optionally, the thyristors can also be protected against short circuit with SITOR semiconductor fuses. Also inrush current peaks are reliably eliminated thanks to settable current limiting.

### Is the SIRIUS 3RW44 communication-capable?

Yes, the SIRIUS 3RW44 can be optionally retrofitted with a PROFIBUS DP module. Thanks to its communication capability, control inputs and programmable relay outputs, the SIRIUS 3RW44 can be very easily and rapidly integrated in superior controls. The utilization of a PROFINET communication module, which is also available as option, offers even more advantages:

- Line and ring bus topologies thanks to integrated switch
- Media redundancy via MRP protocol
- Break function and measured values for energy management via PROFIenergy
- NTP-synchronized time
- Module replacement without PC
- Comprehensive diagnostics and fault alarms
- OPC UA server function for open communication with visualization and control systems

Moreover, you will benefit from the break function and from precise measured values for efficient energy management via PROFIenergy. Further advantages: NTP-synchronized time, module replacement without PC, comprehensive diagnostics and fault alarms as well as the OPC UA server function for open communication with visualization and control systems. Last but not least, operating, service and diagnostics data can be called up via a standard web browser.

### What are the advantages in terms of power loss?

Normally, approx. 3 W heat load are generated per every ampere flowing through an actuated thyristor. For motors with 250 kW (with 400 V), this results in a heating power of roughly 1500 W in the switching device's environment. The SIRIUS 3RW44 coolly handles these hot conditions. As a standard, all versions are equipped with mechanical bypass contacts, which bridge the thyristors after detected motor start-up. This considerably reduces the heat loss occurring during the soft starter's nominal operation. The intelligent hybrid concept, which electronically starts the motor via thyristors and operates it electromechanically via contactor contacts during rated operation, improves the feeder's overall efficiency and additionally reduces the costs for control cabinet dimensioning.

### What if lower speeds are required?

For positioning and set-up tasks, a creep speed function allows for the motor's control in both directions of rotation – with reduced torque and settable low speed.

### What about stopping quickly?

For the fast shutdown of driving loads, a new, combined DC brake function is offered for the SIRIUS 3RW44.

### How about accessories?

We offer a comprehensive range of accessories for our soft starters, e.g. an external display and operator module for installation in the control cabinet door or the plug-on PROFIBUS DP module/PROFINET module. Circuit breaker and soft starter as well as labeling strips from the SIRIUS range are available. Furthermore, easy-to-mount box terminal blocks and sealing covers from the SIRIUS portfolio are available for optimum touch protection.



Easy user guidance via the keypad with a menu-guided, multi-line graphical display



External display and control module which can be installed in the control cabinet door as well as modules for PROFIBUS DP and PROFINET

# Parameterization, Configuration and Visualization

## Comfortable parameterization and evaluation of SIRIUS 3RW44 with Soft Starter ES

With the Soft Starter ES software, the SIRIUS 3RW44 high-feature soft starters can be rapidly and easily parameterized, monitored and diagnosed in service cases. The device parameters can be directly set at the PC and transferred to the soft starter via a serial cable or PROFIBUS/PROFINET connection.

### Advantages of Soft Starter ES

- Transparent online and offline setting of device functions and parameters
- Effective diagnostics functions on the soft starter and visualization of important measured values
- Oscilloscope function (trace) for recording measured values and events
- Time savings through reduced commissioning times

### Practical versions, easy licensing

Soft Starter ES is available in three versions which differ in terms of operating comfort, functional scope and price. A comfortable process eases licensing. Whether Basic, Standard or Premium – the suitable license can be rapidly and comfortably downloaded online. Only the actually utilized scope is invoiced and cost-favorable upgrades are offered. With the trial license, you can test the software's functionality without risk for 14 days. The floating license enables access to any user – independent of the number of installations. Particularly the Standard and Premium license guarantee optimum engineering efficiency.

### Easy creation of templates

For devices with minor differences, the central modification of few parameters in many identical devices or for the easy parameterization of identical applications, Soft Starter ES offers a powerful tool for the simplified creation of parameter files. The typical file contains all possible parameters, which can all be adjusted by the user. The files can also be easily and rapidly transferred to other devices.

### Comfortable parameterization with group function

For the comfortable parameterization of many devices or applications of the same type, the Soft Starter ES software offers a group function which, in connection with the above-described templates, reads out the parameterization of a group of devices and automatically saves it in a separate file, or transfers the parameters from a group of files to the corresponding device groups.

### Teleservice via MPI

The Soft Starter ES Premium version supports use of the MPI teleservice for remote device diagnostics. This eases diagnostics and maintenance and reduces the response time in service cases.

### Standard-compliant print-outs

The software tool considerably simplifies machine documentation as it facilitates the parameterization's print-out in accordance with DIN EN ISO 7200. The elements to be printed can be simply selected and compiled as required.



## Parameterization

Access is either realized via the serial device interface or, with PROFIBUS DPV1/PROFINET-capable soft starters, via any PROFIBUS/PROFINET point. Furthermore, the Premium version supports integration in STEP 7 HW-Config.

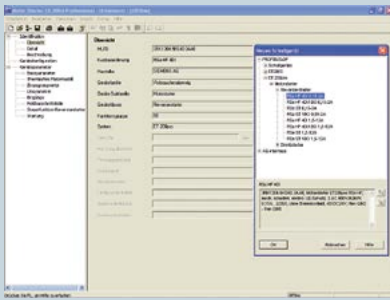

## Commissioning

The soft starters can also be controlled and tested without DP master. For this, the software can either be connected with the soft starters via a point-to-point connection (serial) or communicate with the individual devices via any PROFIBUS (DPV1)/PROFINET point.

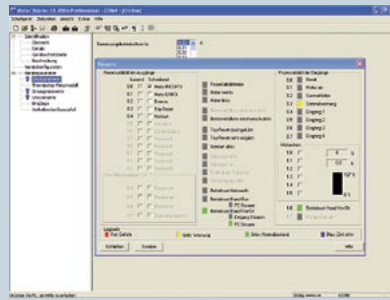

## Diagnostics / Maintenance

Statistical data (e.g. operating hours, switching cycles, switch-off currents, etc.) can be read out for preventive maintenance.

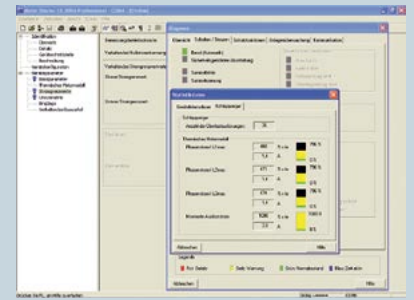

### Program versions:

#### 1. Basic

- Local interface
- Basic functions for device parameterization

#### 2. Standard

- Local interface
- Extended functionality

#### 3. Premium

- Local and PROFIBUS/PROFINET interface
- Full functionality
- Improved comfort

### Our delivery types:

#### Floating License

Full software version on CD with license

#### Upgrade

Upgrade from an old to a new, functionally extended version, e.g. upgrade from Soft Starter ES 2006 to Soft Starter ES 2007

#### Powerpack

Special package for converting to a more powerful version with extended functionality within the same software version, e.g. Powerpack Soft Starter ES 2007 for conversion from Standard to Premium

#### Software update service

Our special service automatically provides you with all service packs and upgrades for up-to-dateness at all times

#### License download

Comfortable license key download from the A&D Mall for easy and fast purchase of additional software licenses

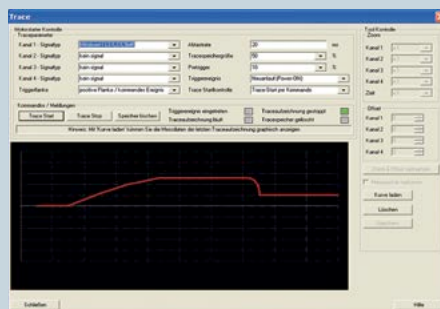

Oscilloscope function with SIRIUS 3RW44 soft starters

### Order data Soft Starter ES

Program versions	Order number
<b>Premium package</b>	
Floating license	3ZS1 313-6CC10-0YA5
License download	3ZS1 313-6CE10-0YB5
Upgrade	3ZS1 313-6CC10-0YE5
Powerpack (Standard > Premium)	3ZS1 313-6CC10-0YD5
Software update service	3ZS1 313-6CC10-0YL5
<b>Standard package</b>	
Floating license	3ZS1 313-5CC10-0YA5
License download	3ZS1 313-5CE10-0YB5
Upgrade	3ZS1 313-5CC10-0YE5
Powerpack (Basic > Standard)	3ZS1 313-5CC10-0YD5
Software update service	3ZS1 313-5CC10-0YL5
<b>Basic package</b>	
Floating license	3ZS1 313-4CC10-0YA5
License download	3ZS1 313-4CE10-0YB5

### Operating system requirements:

Windows 2000 Professional or Windows XP Professional; processor:  $\geq 800$  MHz; required hard disk memory: approx. 150 MB; CD-ROM drive; serial interface

[www.siemens.com/sirius-engineering](http://www.siemens.com/sirius-engineering)

# Parameterization, Configuration and Visualization

## Block library SIRIUS 3RW44 soft starter for SIMATIC PCS 7

The PCS 7 block library facilitates the easy and comfortable integration of SIRIUS 3RW44 soft starters in the SIMATIC PCS 7 process control system. The PCS 7 block library SIRIUS 3RW44 soft starter contains the diagnostics and driver blocks corresponding to the diagnostics and driver concept of SIMATIC PCS 7 as well as all elements required for operation and monitoring (icons and faceplates).

### Advantages of the PCS 7 block library SIRIUS 3RW44 for SIMATIC PCS 7

- Uniform and consistent integration in SIMATIC PCS 7
- Standardized blocks for easy integration and optimum operation
- Improved process transparency thanks to higher information density in the control system
- System-spanning device parameterization and diagnostics with SIMATIC PDM

### Integrated functionality for optimum process guidance in all process control systems

With the integration of SIRIUS 3RW44 soft starters in the process control system, faults in the motor feeder can be easily and reliably prevented or promptly detected and rectified. This reduces downtimes to a minimum and supports their prevention from the start. Also the output and display of the most important measured values determined by the 3RW44 for example represents a helpful tool for assessment and monitoring of the system's current state.

### Easy configuration

The PCS 7 block library provides all blocks required for the automation system – as well as all block icons and faceplates for the operator station required for operation and monitoring. The integration of SIRIUS 3RW44 in SIMATIC PDM facilitates system-spanning device parameterization and diagnostics of 3RW44 soft starters from a central station.

### Motor block for direct drive control

The motor blocks represent the interface between the process control system and the motors controlled by SIRIUS 3RW44. They group all functions for signal processing and provide all information required for operation and monitoring as well as detailed diagnostics.

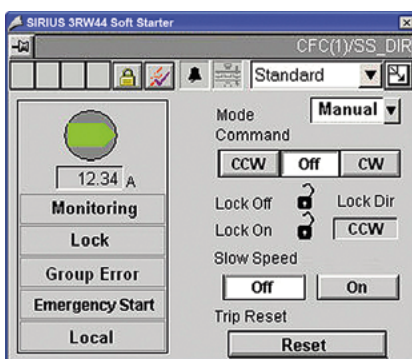

### Evaluation of additional motor feeder measurands

All measured values determined via the soft starter are visualized and logged via the measured value blocks. The faceplate for measured values is called up via the motor block's faceplate. In addition to the detection of measured values, the measured value block also allows for individual settings, for example in order to respond to measured value exceedance or shortfall by means of motor disconnection or warning.

### Evaluation of the motor feeder's maintenance-relevant data

The 3RW44 features powerful functions for the detection and monitoring of maintenance-relevant motor feeder data. For example, the motor's operation time and downtime, switching cycles and overload tripping events are directly detected and saved in the device and provided via the statistics block in the control system if required.

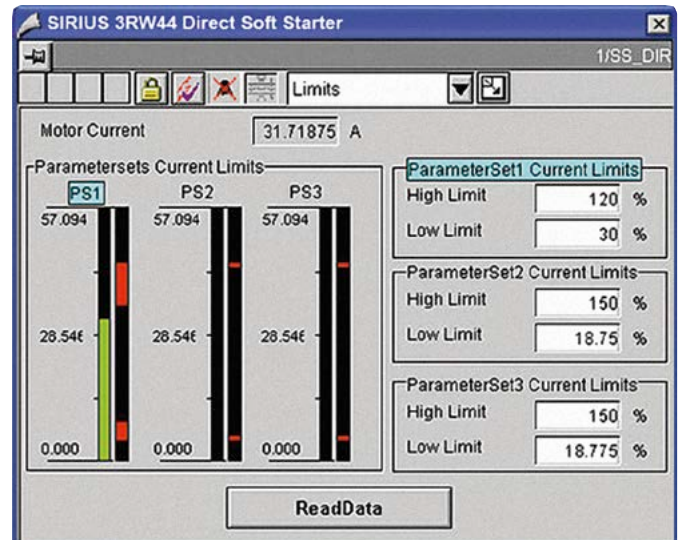

### Delivery and license types

Scope of supply: AS blocks and faceplates for the integration of SIRIUS 3RW44 in the PCS 7 process control system, for PCS 7 version 6.1/V7.0 and V8.0

### Engineering software

The PCS 7 block library SIRIUS 3RW44 soft starter supplied on CD-ROM entitles the user to execute the required engineering software on an engineering station (single license), including the runtime software for execution of the AS blocks in an automation system (single license).

### Ordering data

CD, incl. electronic documentation:  
For PCS 7 V6.1/V7.0: 3ZS1 633-1XX00-0YA0  
For PCS 7 V8.0: 3ZS1 633-1XX02-0YA0

### Runtime software

For application of the AS blocks in a further automation system, the respective number of runtime licenses is required, which are supplied without data carrier.

### Ordering data

License without software and documentation:  
For PCS 7 V6.1/V7.0: 3ZS1 633-2XX00-0YB0  
For PCS 7 V8.0: 3ZS1 633-2XX02-0YB0

Upgrade for PCS 7 SIRIUS 3RW44 block library, V6.0 or V7 to the version SIRIUS 3RW44 V8: 3ZS1633-1XX02-0YE0

Engineering software migration V7-V8 for upgrade (migration) of an existing engineering software V 6.1/V7.0/V7.1 to V8.0 of the SIRIUS 3RW44 soft starter block library for PCS 7: 3ZS1 633-1XX10-0YE0



# SIRIUS Soft Starters in Practical Use

## Application Examples



SIRIUS 3RW30 – for soft reversing operation of roller conveyors

Roller conveyors are, for example, employed in parcel distribution systems for transporting parcels to and from individual work stations. For this purpose, the direction of rotation of the used 11-kW motor has to be adjustable in order to realize both conveyance directions.

### **Roller conveyors pose high requirements**

- The roller conveyor has to start smoothly to prevent damage to the transported goods due to slipping or tilting.
- The machine's wear and maintenance intervals should be minimized, which is why slippage of the belt drive during start-up must be prevented.
- The current load upon motor start-up is to be reduced by means of a voltage ramp.
- The feeder assembly should be as small as possible so as to not exceed the control cabinet's space capacity.

### **Optimum performance with SIRIUS 3RW30**

- The roller conveyor is rapidly accelerated to the nominal speed without torque surges thanks to optimum setting of the voltage ramp during start-up.
- The motor's starting current is reduced.
- Reversing operation of the conveyor belt is realized through contactor interconnection with SIRIUS 3RA13 reversing contactor combinations.
- Feeder and motor protection are realized with SIRIUS 3RV circuit breakers.
- The use of SIRIUS system components guarantees maximum wiring reductions and space savings.



SIRIUS 3RW40 – for soft starting of hydraulic pumps

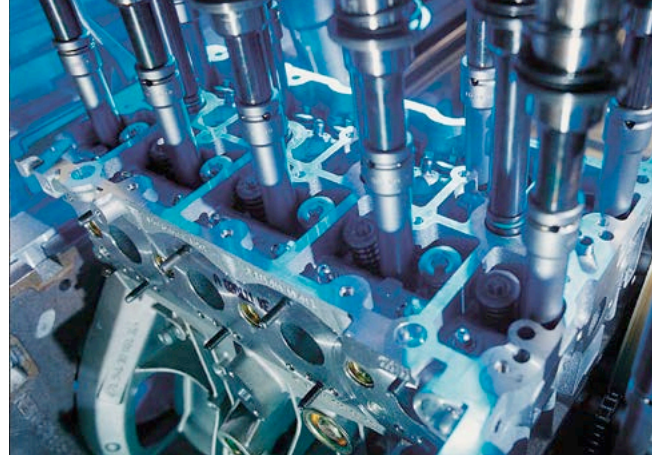

SIRIUS 3RW44 – for soft starting of milling machines with DC braking

In addition to many further application areas, the SIRIUS 3RW40 is optimally suited for the soft start and stop of hydraulic pumps. With a rating of 200 kW, these soft starters are for example used in the production of sheet parts, to drive the respective presses.

#### Hydraulic pumps require sensitive drives

- The motor's starting current has to be reduced to minimize the load of the superior mains transformer during start-up.
- Normally, integrated motor protection is called for to reduce wiring expenditures and space requirements in the control box.
- The hydraulic pump is to be started and stopped in a soft manner, to minimize the mechanical load on the drive and the pump caused by the torque surge during starting and stopping.

#### The SIRIUS 3RW40 offers this sensitivity as a standard

- The settable current limiting of the SIRIUS 3RW40 limits the load of the mains transformer during motor start-up.
- Motor protection is ensured by the motor overload relay with settable trip classes integrated in the soft starter.

The adjustable voltage ramp ensures the hydraulic pump's start and stop without torque surges. For the production of motor blocks, the required bores are drilled in the motor's aluminum block by means of a milling head. Due to the milling head's high inertia, shutdown of the 15-kW motor is subject to long stopping times, which cause long down-times for tool changes and set-up operation.

#### The start-up behavior of milling machines requires maximum functionality

- To prevent excessive wear of the drive belts due to slippage, milling machines require an optimized and torque-controlled start-up behavior.
- The motor's starting current has to be reduced to minimize the mains load.
- The motor has to be braked with DC current to reduce the machine's long stopping times.

#### Competent solution with SIRIUS 3RW44

- To optimally master the difficult starting conditions, the SIRIUS 3RW44 with torque control and dynamic DC brake function is employed.
- Slippage of the belts during start-up is prevented by torque control with adjusted torque limiting function. This rapidly accelerates the milling head to the nominal speed without slippage of the belt drives.
- A higher-level current limiting function reduces the motor's starting current to a set maximum value.
- The optimum setting of the dynamic DC brake function shuts the milling head down in minimum time.
- Also motor and device overload protection is excellently mastered by the SIRIUS 3RW44 high-feature soft starter.

# Overview of SIRIUS Soft Starters

## Technical Data

Overview of SIRIUS soft starters		Standard applications		High-feature applications
		SIRIUS 3RW30	SIRIUS 3RW40	SIRIUS 3RW44
				
Rated current at 40 °C	A	3.6 ... 106	12.5 ... 432	29 ... 1214
Rated voltage	V	200 ... 480	200 ... 600	200 ... 690
Motor power with 400 V (standard circuit)	kW	1.1 ... 55	5.5 ... 250	15 ... 710
Motor power with 400 V (inside-delta circuit)	kW	–	–	22 ... 1214
Ambient temperature (operation)	°C	–25 ... 60	–25 ... 60	0 ... 60
Soft start/stop		x <sup>1)</sup>	x	x
Voltage ramp		x	x	x
Starting/stopping voltage	%	40 ... 100	40 ... 100	20 ... 100
Ramp-up and ramp-down time	s	0 ... 20 <sup>1)</sup>	0 ... 20	1 ... 360
Torque control		–	–	x
Starting/stopping torque	%	–	–	20 ... 100
Torque limiting	%	–	–	20 ... 100
Ramp time	s	–	–	1 ... 360
Integrated bypass contact system		x	x	x
Intrinsic device protection		–	x	x
Motor overload protection		–	x <sup>7)</sup>	x
Thermistor motor protection		–	x <sup>2)</sup>	x
Integrated remote reset		–	x <sup>3)</sup>	x
Settable current limiting		–	x	x
Inside-delta circuit		–	–	x
Breakaway torque		–	–	x
Creep speed in both directions of rotation		–	–	x
Pump stop		–	–	x <sup>4)</sup>
DC braking		–	–	x <sup>4) 5)</sup>
Combined braking		–	–	x <sup>4) 5)</sup>
Motor heating		–	–	x
Communication		–	–	with PROFIBUS DP/ PROFINET (option)
External display and operator module		–	–	(option)
Status measured value display		–	–	x
Error log		–	–	x
Event list		–	–	x
Non-return pointer function		–	–	x
Trace function		–	–	x <sup>6)</sup>
Programmable control inputs and outputs		–	–	x
Number of parameter sets		1	1	3
Parameterization software (Soft Starter ES)		–	–	x
PCS 7 faceplates		–	–	x
Power semiconductors (thyristors)		2 controlled phases	2 controlled phases	3 controlled phases
Screw-type terminals		x	x	x
Spring-loaded terminals		x	x	x
UL/CSA		x	x	x
CE mark		x	x	x
Soft starting and heavy-duty starting conditions		–	–	x <sup>4)</sup>
Configuration support		Electronic selection slide, Technical Assistance +49 911 895 5900		

<sup>1)</sup> 3RW30 only soft start

<sup>2)</sup> Optionally up to size S3 (device version)

<sup>3)</sup> With 3RW40 2. up to 3RW40 4.; with 3RW40 5. and 3RW40 7. optional

<sup>4)</sup> Overdimensioning of soft starter and motor if required

<sup>5)</sup> Not possible with inside-delta circuit

<sup>6)</sup> Trace function with Soft Starter ES software

<sup>7)</sup> Motor overload protection (ATEX) to be used in combination

with a contactor

X = Function available

– = Function not available

# Effective Selection of SIRIUS Soft Starters

Auswahlhilfe für SIRIUS Sanftstarter  
Selection Tool for SIRIUS Soft Starter



SIRIUS

Answers for industry.

SIEMENS

## Typical application areas

### Standard applications

- Construction/construction material machines
- Presses
- Escalators
- Transportation systems
- Pumps
- Fans
- Air-conditioning systems
- Ventilators
- Conveyor belts
- Compressors and cooling systems
- Drives

### High-feature applications

- Pumps (also oil industry)
- Ventilators
- Compressors
- Industrial cooling systems
- Industrial refrigerating systems
- Water transportation
- Conveyor systems and elevators
- Hydraulic systems
- Machine tools
- Mills
- Saws
- Crushers
- Mixers
- Centrifuges

Order number: E20001-Y590-P302-X-7400

The selection tool for SIRIUS soft starters provides a reference value for finding the suitable starter size for your application or for your star-delta start-up to be replaced. We recommend our Siemens Technical Assistance for dimensioning soft starters for motors with high starting current conditions (typically  $I/I_e \geq 8$ ).

Technical Assistance:

Competent technical support  
with all industrial control subjects:

+49 (0) 911-895-5900

[technical-assistance@siemens.com](mailto:technical-assistance@siemens.com)

[www.siemens.de/industrial-controls/technical-assistance](http://www.siemens.de/industrial-controls/technical-assistance)

Scan the  
QR code  
for further  
information



## More information

Personally from Monday to Friday from 8.00 am to 5.00 pm (CET)

Telephone: +49 911 895 5900

E-mail: [technical-assistance@siemens.com](mailto:technical-assistance@siemens.com)

Fax: +49 911 895 5907

Siemens AG  
Industry Sector  
Industry Automation  
Control Components and  
Systems Engineering  
P.O. Box 23 55  
90713 FÜRTH  
GERMANY

Subject to change without prior notice 08/13  
Order No.: E20001-A1040-P302-V5-7600  
Dispo 27601  
WÜ/46842 MI.CE.SG.SRXX.52.3.05 WS 08133.  
Printed in Germany  
© Siemens AG 2013

The information provided in this brochure contains merely general descriptions or characteristics of performance which in case of actual use do not always apply as described or which may change as a result of further development of the products. An obligation to provide the respective characteristics shall only exist if expressly agreed in the terms of contract.

All product designations may be trademarks or product names of Siemens AG or supplier companies whose use by third parties for their own purposes could violate the rights of the owners.



**SIEMENS**





[siemens.com/sirius-soft-starter](http://siemens.com/sirius-soft-starter)

# SIRIUS Soft Starters

Technical Data

Answers for industry.

# The Range at a Glance – Overview of SIRIUS Soft Star

		Standard applications				
		SIRIUS 3RW3003	SIRIUS 3RW30			
						
<b>Control electronics</b>		3RW3003-.CB54	3RW30...-BB0.		3RW30...-BB1.	
<b>Rated control supply voltage</b>	V	AC/DC 24 ... 230 (±10 %)	AC/DC 24 (±20 %)		AC/DC 110 ... 230 (-15 %/+10 %)	
<b>Rated control supply current</b>	mA	approx. 25 ... 4	approx. 50		approx. 25 ... 20	
<b>Rated frequency</b>	Hz	50/60 (±10 %)	50/60 (±10 %)		50/60 (±10 %)	
<b>Power electronics</b>		3RW3003-.CB54	3RW30...-.B.4			
<b>Rated operating voltage</b>	V	AC 200 ... 400 (±10 %)	AC 200 ... 480 (-15 %/+10 %)			
<b>Rated frequency</b>	Hz	50/60 (±10 %)	50/60 (-10 %/+10 %)		50/60 (±10 %)	
<b>Rated operating current I<sub>e</sub> (AC-53a)</b>			3RW301.	3RW302.	3RW303.	3RW304.
at 40 °C	A	3	3.6/6.5/9/12.5/17.6	25/32/38	45/63/72	80/106
at 50 °C	A	2.6	3/6/8/12/17	23/29/34	42/58/62	73/98
at 60 °C	A	2.2	3/5.5/7/11/14	21/26/31	39/53/60	66/90
<b>Permissible ambient temperature</b>	°C	-25 ... +60	-25 ... +60	-25 ... +60	-25 ... +60	-25 ... +60
<b>Size</b>		22.5 mm	S00	S0	S2	S3

## Overview of accessories and spare parts for SIRIUS soft starters

		SIRIUS 3RW3003	SIRIUS 3RW30			
<b>Accessories</b>		3RW3003	3RW301.	3RW302.	3RW303.	3RW304.
<b>Terminal block</b>		–	–	–	–	–
<b>Terminal covers for box terminals</b>		–	–	–	3RT1936-4EA2	3RT1946-4EA2
<b>Connection cover for cable lug and busbar connection</b>		–	–	–	–	3RT1946-4EA1
<b>Sealing cover</b>		3RP1902	–	–	3RW4900-0PB10	3RW4900-0PB10
<b>Parameterization and service software Soft Starter ES 2007 Basic</b>		–	–	–	–	–
<b>Parameterization and service software Soft Starter ES 2007 Standard</b>		–	–	–	–	–
<b>Parameterization and service software Soft Starter ES 2007 Premium</b>		–	–	–	–	–
<b>Block library SIRIUS 3RW44 soft starter for SIMATIC PCS 7 (PCS 7 Version v6.1/V7.0)</b>						
– Engineering software, German-English, on CD, incl. electronic documentation		–	–	–	–	–
– Runtime software (license without software and documentation)		–	–	–	–	–
<b>PC cable for connection PC-3RW44 USB interface adapter</b>		–	–	–	–	–
<b>PROFIBUS DP communication module</b>		–	–	–	–	–
<b>PROFINET communication module</b>		–	–	–	–	–
<b>External display and operator module</b>		–	–	–	–	–
<b>Connection cable (e.g. 2.5 m) 3RW44 – ext. display module</b>		–	–	–	–	–
<b>Fans</b>		–	–	–	–	–
<b>Spare parts</b>						
<b>Fans</b>		–	–	–	–	–
		–	–	–	–	–

## SIRIUS 3RW40



3RW40...-B0.		3RW40...-B1.		3RW40...-BB3.		3RW40...-BB4.	
AC/DC 24 (±20 %)		AC/DC 110 ... 230 (-15 %/+10 %)		AC 115 (-15 %/+10 %)		AC 230 (-15 %/+10 %)	
approx. 50		approx. 25 ... 20		-		-	
50/60 (±10 %)		50/60 (±10 %)		50/60 (±10 %)		50/60 (±10 %)	
3RW40...-B.4		3RW40...-B.5		3RW40...-BB.4		3RW40...-BB.5	
AC 200 ... 480 (-15 %/+10 %)		AC 400 ... 600 (-15 %/+10 %)		AC 200 ... 460 (-15 %/+10 %)		AC 400 ... 600 (-15 %/+10 %)	
50/60 (±10 %)		50/60 (±10 %)		50/60 (±10 %)		50/60 (±10 %)	
3RW402.	3RW403.	3RW404.		3RW405.		3RW407.	
12.5/25/32/38	45/63/72	80/106		134/162		230/280/356/432	
11/23/29/34	42/58/62	73/98		117/145		205/248/315/385	
10/21/26/31	39/53/60	66/90		100/125		180/215/280/335	
-25 ... +60	-25 ... +60	-25 ... +60		-25 ... +60		-25 ... +60	
S0	S2	S3		S6		S12	

## SIRIUS 3RW40

3RW402.	3RW403.	3RW404.	3RW405.	3RW407.
-	-	-	3RT1955-4G up to 70 mm <sup>2</sup>	3RT1966-4G up to 240 mm <sup>2</sup>
-	-	-	3RT1956-4G up to 120 mm <sup>2</sup>	-
-	3RT1936-4EA2	3RT1946-4EA2	3RT1956-4EA2	3RT1966-4EA2
-	-	3RT1946-4EA1	3RT1956-4EA1	3RT1966-4EA1
3RW4900-0PB10	3RW4900-0PB10	3RW4900-0PB10	3RW4900-0PB00	3RW4900-0PB00
-	-	-	-	-
-	-	-	-	-
-	-	-	-	-
-	-	-	-	-
-	-	-	-	-
-	-	-	-	-
-	-	-	-	-
3RW4928-8VB00	3RW4947-8VB00	3RW4947-8VB00	-	-
3RW4928-8VB00	3RW4947-8VB00	3RW4947-8VB00	3RW4936-8VX30 AC 115 V	3RW4947-8VX30 AC 115 V
-	-	-	3RW4936-8VX40 AC 230 V	3RW4947-8VX40 AC 230 V

## High-feature applications

### SIRIUS 3RW44



3RW44...-BC3.		3RW44...-BC4.	
AC 115 (-15 %/+10 %)		AC 230 (-15 %/+10 %)	
-		-	
50 ... 60 (±10 %)		50 ... 60 (±10 %)	
3RW44...-BC.4		3RW44...-BC.5	
AC 200 ... 460 (-15 %/+10 %)		AC 400 ... 600 (-15 %/+10 %)	
50/60 (±10 %)		50/60 (±10 %)	
22 versions		22 versions	
29 ... 1214		29 ... 1214	
26 ... 1076		26 ... 1076	
23 ... 970		23 ... 970	
0 ... 60		0 ... 60	
-		-	
3RW44...-BC.4		3RW44...-BC.6	
AC 400 ... 690 (-15 %/+10 %)		AC 400 ... 690 (-15 %/+10 %)	
50/60 (±10 %)		50/60 (±10 %)	
22 versions		22 versions	
29 ... 1214		29 ... 1214	
26 ... 1076		26 ... 1076	
23 ... 970		23 ... 970	
0 ... 60		0 ... 60	
-		-	

### SIRIUS 3RW44

3RW442.	3RW443.	3RW444.	3RW445. / 3RW446. <sup>1)</sup>
included in scope of supply	3RT1955-4G up to 70 mm <sup>2</sup>	3RT1966-4G up to 240 mm <sup>2</sup>	-
-	3RT1956-4G up to 120 mm <sup>2</sup>	-	-
3RT1956-4EA2	3RT1956-4EA2	3RT1966-4EA2	-
3RT1956-4EA1	3RT1956-4EA1	3RT1966-4EA1	-
-	-	-	-
3ZS1313-4CC10-0YA5	3ZS1313-4CC10-0YA5	3ZS1313-4CC10-0YA5	3ZS1313-4CC10-0YA5
3ZS1313-5CC10-0YA5	3ZS1313-5CC10-0YA5	3ZS1313-5CC10-0YA5	3ZS1313-5CC10-0YA5
3ZS1313-6CC10-0YA5	3ZS1313-6CC10-0YA5	3ZS1313-6CC10-0YA5	3ZS1313-6CC10-0YA5
-	-	-	-
3ZS1 633-1XX00-0YA0	3ZS1 633-1XX00-0YA0	3ZS1 633-1XX00-0YA0	3ZS1 633-1XX00-0YA0
3ZS1 633-2XX00-0YB0	3ZS1 633-2XX00-0YB0	3ZS1 633-2XX00-0YB0	3ZS1 633-2XX00-0YB0
3UF7940-0AA00-0	3UF7940-0AA00-0	3UF7940-0AA00-0	3UF7940-0AA00-0
2SX5 100-3PC07	2SX5 100-3PC07	2SX5 100-3PC07	2SX5 100-3PC07
3RW4900-0KC00	3RW4900-0KC00	3RW4900-0KC00	3RW4900-0KC00
3RW4900-0NC00	3RW4900-0NC00	3RW4900-0NC00	3RW4900-0NC00
0YA033RW4900-0AC00	0YB03RW4900-0AC00	0YB03RW4900-0AC00	0YB03RW4900-0AC00
3UF7933-0BA00-0	3UF7933-0BA00-0	3UF7933-0BA00-0	3UF7933-0BA00-0
-	-	-	-
3RW4936-8VX30 AC 115 V	3RW4936-8VX30 AC 115 V	3RW4947-8VX30 AC 115 V	3RW4957-8VX30 AC 115 V
3RW4936-8VX40 AC 230 V	3RW4936-8VX40 AC 230 V	3RW4947-8VX40 AC 230 V	3RW4957-8VX40 AC 230 V

<sup>1)</sup> Front-installed fan with 3RW446.  
3RW4966-8VX30 AC 115 V  
3RW4966-8VX40 AC 230 V

# SIRIUS 3RW30 for normal starting

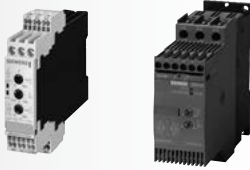

Rated operating voltage $U_e$	Rated operating current $I_e$	Rated power of three-phase motors with rated operating voltage $U_e$			Rated operating current $I_e$	Rated power of three-phase motors with rated operating voltage $U_e$				Order No.
Ambient temperature 40 °C					Ambient temperature 50 °C					
V	A	230 V kW	400 V kW	500 V kW	A	200 V hp	230 V hp	460 V hp	575 V hp	
Soft starters for simple start-up conditions and high switching frequencies <sup>1)</sup>										
200 ... 400	3	0.55	1.1	–	2.6	0.5	0.5	–	–	3RW30 03- <input type="checkbox"/> CB54
									↑	
Order No. supplement for connection type									with screw-type terminals	1
									with spring-loaded terminals	2
V	A <sup>2)</sup>	230 V kW	400 V kW	500 V kW	A <sup>2)</sup>	200 V hp	230 V hp	460 V hp	575 V hp	
Soft starters for three-phase asynchronous motors										
200 ... 400	3.6	0.75	1.5	–	3	0.5	0.5	1.5	–	3RW3013- <input type="checkbox"/> BB <input type="checkbox"/> 4
	6.5	1.5	3	–	4.8	1	1	3	–	3RW3014- <input type="checkbox"/> BB <input type="checkbox"/> 4
	9	2.2	4	–	7.8	2	2	5	–	3RW3016- <input type="checkbox"/> BB <input type="checkbox"/> 4
	12.5	3	5.5	–	11	3	3	7.5	–	3RW3017- <input type="checkbox"/> BB <input type="checkbox"/> 4
	17.6	4	7.5	–	17	3	3	10	–	3RW3018- <input type="checkbox"/> BB <input type="checkbox"/> 4
	25	5.5	11	–	23	5	5	15	–	3RW3026- <input type="checkbox"/> BB <input type="checkbox"/> 4
	32	7.5	15	–	29	7.5	7.5	20	–	3RW3027- <input type="checkbox"/> BB <input type="checkbox"/> 4
	38	11	18.5	–	34	10	10	25	–	3RW3028- <input type="checkbox"/> BB <input type="checkbox"/> 4
	45	11	22	–	42	10	15	30	–	3RW3036- <input type="checkbox"/> BB <input type="checkbox"/> 4
	63	18.5	30	–	58	15	20	40	–	3RW3037- <input type="checkbox"/> BB <input type="checkbox"/> 4
	72	22	37	–	62	20	20	40	–	3RW3038- <input type="checkbox"/> BB <input type="checkbox"/> 4
	80	22	45	–	73	20	25	50	–	3RW3046- <input type="checkbox"/> BB <input type="checkbox"/> 4
	106	30	55	–	98	30	30	75	–	3RW3047- <input type="checkbox"/> BB <input type="checkbox"/> 4
	Order No. supplement for connection type									↑
									with screw-type terminals	1
									with spring-loaded terminals	2
Order No. supplement for rated control supply voltage $U_s$									AC/DC 24 V	0
									AC/DC 110 ... 230 V	1

# SIRIUS 3RW40 for normal starting (CLASS 10)



Rated operating voltage $U_e$	Rated operating current $I_e$	Rated power of three-phase motors with rated operating voltage $U_e$	Rated operating current $I_e$	Rated power of three-phase motors with rated operating voltage $U_e$	Order No.
-------------------------------	-------------------------------	--	-------------------------------	--	-----------

Ambient temperature 40 °C					Ambient temperature 50 °C					
V	A <sup>1)</sup>	230 V kW	400 V kW	500 V kW	A <sup>1)</sup>	200 V hp	230 V hp	460 V hp	575 V hp	
200 ... 480	12.5	3	5.5	–	11	3	3	7.5	–	3RW4024-□□ B□4
	25	5.5	11	–	23	5	5	15	–	3RW4026-□□ B□4
	32	7.5	15	–	29	7.5	7.5	20	–	3RW4027-□□ B□4
	38	11	18.5	–	34	10	10	25	–	3RW4028-□□ B□4
	45	11	22	–	42	10	15	30	–	3RW4036-□□ B□4
	63	18.5	30	–	58	15	20	40	–	3RW4037-□□ B□4
	72	22	37	–	62	20	20	40	–	3RW4038-□□ B□4
	80	22	45	–	73	20	25	50	–	3RW4046-□□ B□4
106	30	55	–	98	25	30	75	–	3RW4047-□□ B□4	
400 ... 600	12.5	–	5.5	7.5	11	–	–	7.5	10	3RW4024-□□ B□5
	25	–	11	15	23	–	–	15	20	3RW4026-□□ B□5
	32	–	15	18.5	29	–	–	20	25	3RW4027-□□ B□5
	38	–	18.5	22	34	–	–	25	30	3RW4028-□□ B□5
	45	–	22	30	42	–	–	30	40	3RW4036-□□ B□5
	63	–	30	37	58	–	–	40	50	3RW4037-□□ B□5
	72	–	37	45	62	–	–	40	60	3RW4038-□□ B□5
	80	–	45	55	73	–	–	50	60	3RW4046-□□ B□5
106	–	55	75	98	–	–	75	75	3RW4047-□□ B□5	

Order No. supplement for connection type

Order No. supplement for thermistor motor protection

Order No. supplement for rated control supply voltage  $U_s$

Screw-type terminals  
Spring-loaded terminals  
Standard function  
Integrated thermistor motor protection<sup>2)</sup>  
AC/DC 24 V  
AC/DC 110 ... 230 V

↑ ↑ ↑  
1  
2  
B  
T  
0  
1



V	A	230 V kW	400 V kW	500 V kW	A	200 V hp	230 V hp	460 V hp	575 V hp	
Soft starters for three-phase asynchronous motors										
200 ... 460	134	37	75	–	117	30	40	75	–	3RW4055-□BB□4
	162	45	90	–	145	40	50	100	–	3RW4056-□BB□4
	230	75	132	–	205	60	75	150	–	3RW4073-□BB□4
	280	90	160	–	248	75	100	200	–	3RW4074-□BB□4
	356	110	200	–	315	100	125	250	–	3RW4075-□BB□4
432	132	250	–	385	125	150	300	–	3RW4076-□BB□4	
400 ... 600	134	–	75	90	117	–	–	75	100	3RW4055-□BB□5
	162	–	90	110	145	–	–	100	150	3RW4056-□BB□5
	230	–	132	160	205	–	–	150	200	3RW4073-□BB□5
	280	–	160	200	248	–	–	200	250	3RW4074-□BB□5
	356	–	200	250	315	–	–	250	300	3RW4075-□BB□5
432	–	250	315	385	–	–	300	400	3RW4076-□BB□5	

Order No. supplement for connection type

Order No. supplement for rated control supply voltage  $U_s$

Spring-loaded terminals  
Screw-type terminals  
AC 115 V  
AC 230 V

↑ ↑  
1  
2  
0  
1

# SIRIUS 3RW40 for heavy-duty starting (CLASS 20)



Rated operating voltage $U_e$	Rated operating current $I_e$	Rated power of three-phase motors with rated operating voltage $U_e$			Rated operating current $I_e$	Rated power of three-phase motors with rated operating voltage $U_e$				Order No.
Ambient temperature 40 °C					Ambient temperature 50 °C					
V	A <sup>1)</sup>	230 V kW	400 V kW	500 V kW	A <sup>1)</sup>	200 V hp	230 V hp	460 V hp	575 V hp	
200 ... 480	12.5	3	5.5	–	11	3	3	7.5	–	3RW4026-□□ B□4
	25	5.5	11	–	23	5	5	15	–	3RW4027-□□ B□4
	32	7,5	15	–	29	7.5	7.5	20	–	3RW4036-□□ B□4
	38	11	18.5	–	34	10	10	25	–	3RW4037-□□ B□4
	45	11	22	–	42	10	15	30	–	3RW4037-□□ B□4
	63	18.5	30	–	58	15	20	40	–	3RW4047-□□ B□5
400 ... 600	25	–	11	15	23	–	–	15	20	3RW4027-□□ B□5
	32	–	15	18.5	29	–	–	20	25	3RW4036-□□ B□5
	38	–	18.5	22	34	–	–	25	30	3RW4037-□□ B□5
	45	–	22	30	42	–	–	30	40	3RW4037-□□ B□5
	63	–	30	37	58	–	–	40	50	3RW4047-□□ B□5
	72	–	37	45	62	–	–	40	60	3RW4047-□□ B□5

Order No. supplement for connection type      Screw-type terminals      ↑

Order No. supplement for thermistor motor protection      Spring-loaded terminals      1

Order No. supplement for rated control supply voltage  $U_s$       Standard function      2

AC/DC 24 V      Integrated thermistor motor protection<sup>2)</sup>      B

AC/DC 110 ... 230 V      AC/DC 110 ... 230 V      T

0

1



V	A	230 V kW	400 V kW	500 V kW	A	200 V hp	230 V hp	460 V hp	575 V hp	
<b>Soft starters for three-phase asynchronous motors</b>										
200 ... 460	80	22	45	–	73	20	25	50	–	3RW4055-□BB□4
	106	30	55	–	98	25	30	60	–	3RW4055-□BB□4
	134	37	75	–	117	30	40	75	–	3RW4056-□BB□4
	162	45	90	–	145	40	50	100	–	3RW4073-□BB□4
	230	75	132	–	205	60	75	150	–	3RW4074-□BB□4
	280	90	160	–	248	75	100	200	–	3RW4075-□BB□4
400 ... 600	356	110	200	–	315	100	125	250	–	3RW4076-□BB□4
	80	–	45	55	73	–	–	50	60	3RW4055-□BB□5
	106	–	55	75	98	–	–	60	75	3RW4055-□BB□5
	134	–	75	90	117	–	–	75	100	3RW4056-□BB□5
	162	–	90	110	145	–	–	100	150	3RW4073-□BB□5
	230	–	132	160	205	–	–	150	200	3RW4074-□BB□5
280	–	160	200	248	–	–	200	250	3RW4075-□BB□5	
	–	200	250	315	–	–	250	300	3RW4076-□BB□5	

Order No. supplement for connection type      Spring-loaded terminals      ↑

Order No. supplement for rated control supply voltage  $U_s$       Screw-type terminals      2

AC 115 V      AC 115 V      6

AC 230 V      AC 230 V      3

4

<sup>1)</sup> Stand-alone assembly, without additional fan

<sup>2)</sup> Only possible in connection with control supply voltage AC/DC 24 V

Please observe the configuration notes and boundary conditions on page 14 and 15!



# SIRIUS 3RW44

## for normal starting (CLASS 10)

### in standard circuit

Rated operating voltage $U_e$	Rated operating current $I_e$	Rated power of three-phase motors with rated operating voltage $U_e$				Rated operating current $I_e$	Rated power of three-phase motors with rated operating voltage $U_e$				Order No.
		230 V kW	400 V kW	500 V kW	690 V kW		200 V hp	230 V hp	460 V hp	575 V hp	
Ambient temperature 40 °C											
Ambient temperature 50 °C											
V	A	230 V kW	400 V kW	500 V kW	690 V kW	A	200 V hp	230 V hp	460 V hp	575 V hp	
200 ... 460	29	5.5	15	–	–	26	7.5	7.5	15	–	3RW44 22- □ BC □ 4
	36	7.5	18.5	–	–	32	10	10	20	–	3RW44 23- □ BC □ 4
	47	11	22	–	–	42	10	15	25	–	3RW44 24- □ BC □ 4
	57	15	30	–	–	51	15	15	30	–	3RW44 25- □ BC □ 4
	77	18.5	37	–	–	68	20	20	50	–	3RW44 26- □ BC □ 4
	93	22	45	–	–	82	25	25	60	–	3RW44 27- □ BC □ 4
400 ... 600	29	–	15	18.5	–	26	–	–	15	20	3RW44 22- □ BC □ 5
	36	–	18.5	22	–	32	–	–	20	25	3RW44 23- □ BC □ 5
	47	–	22	30	–	42	–	–	25	30	3RW44 24- □ BC □ 5
	57	–	30	37	–	51	–	–	30	40	3RW44 25- □ BC □ 5
	77	–	37	45	–	68	–	–	50	50	3RW44 26- □ BC □ 5
	93	–	45	55	–	82	–	–	60	75	3RW44 27- □ BC □ 5
400 ... 690	29	–	15	18.5	30	26	–	–	15	20	3RW44 22- □ BC □ 6
	36	–	18.5	22	37	32	–	–	20	25	3RW44 23- □ BC □ 6
	47	–	22	30	45	42	–	–	25	30	3RW44 24- □ BC □ 6
	57	–	30	37	55	51	–	–	30	40	3RW44 25- □ BC □ 6
	77	–	37	45	75	68	–	–	50	50	3RW44 26- □ BC □ 6
	93	–	45	55	90	82	–	–	60	75	3RW44 27- □ BC □ 6
Order No. supplement for connection type											
Screw-type terminals											
Spring-loaded terminals											
200 ... 460	113	30	55	–	–	100	30	30	75	–	3RW44 34- □ BC □ 4
	134	37	75	–	–	117	30	40	75	–	3RW44 35- □ BC □ 4
	162	45	90	–	–	145	40	50	100	–	3RW44 36- □ BC □ 4
	203	55	110	–	–	180	50	60	125	–	3RW44 43- □ BC □ 4
	250	75	132	–	–	215	60	75	150	–	3RW44 44- □ BC □ 4
	313	90	160	–	–	280	75	100	200	–	3RW44 45- □ BC □ 4
	356	110	200	–	–	315	100	125	250	–	3RW44 46- □ BC □ 4
	432	132	250	–	–	385	125	150	300	–	3RW44 47- □ BC □ 4
	551	160	315	–	–	494	150	200	400	–	3RW44 53- □ BC □ 4
	615	200	355	–	–	551	150	200	450	–	3RW44 54- □ BC □ 4
	693	200	400	–	–	615	200	250	500	–	3RW44 55- □ BC □ 4
	780	250	450	–	–	693	200	250	600	–	3RW44 56- □ BC □ 4
	880	250	500	–	–	780	250	300	700	–	3RW44 57- □ BC □ 4
	970	315	560	–	–	850	300	350	750	–	3RW44 58- □ BC □ 4
	1076	355	630	–	–	970	350	400	850	–	3RW44 65- □ BC □ 4
	1214	400	710	–	–	1076	350	450	950	–	3RW44 66- □ BC □ 4
400 ... 600	113	–	55	75	–	100	–	–	75	75	3RW44 34- □ BC □ 5
	134	–	75	90	–	117	–	–	75	100	3RW44 35- □ BC □ 5
	162	–	90	110	–	145	–	–	100	125	3RW44 36- □ BC □ 5
	203	–	110	132	–	180	–	–	125	150	3RW44 43- □ BC □ 5
	250	–	132	160	–	215	–	–	150	200	3RW44 44- □ BC □ 5
	313	–	160	200	–	280	–	–	200	250	3RW44 45- □ BC □ 5
	356	–	200	250	–	315	–	–	250	300	3RW44 46- □ BC □ 5
	432	–	250	315	–	385	–	–	300	400	3RW44 47- □ BC □ 5
	551	–	315	355	–	494	–	–	400	500	3RW44 53- □ BC □ 5
	615	–	355	400	–	551	–	–	450	600	3RW44 54- □ BC □ 5
	693	–	400	500	–	615	–	–	500	700	3RW44 55- □ BC □ 5
	780	–	450	560	–	693	–	–	600	750	3RW44 56- □ BC □ 5
	880	–	500	630	–	780	–	–	700	850	3RW44 57- □ BC □ 5
	970	–	560	710	–	850	–	–	750	900	3RW44 58- □ BC □ 5
	1076	–	630	800	–	970	–	–	850	1100	3RW44 65- □ BC □ 5
	1214	–	710	900	–	1076	–	–	950	1200	3RW44 66- □ BC □ 5
400 ... 690	113	–	55	75	110	100	–	–	75	75	3RW44 34- □ BC □ 6
	134	–	75	90	132	117	–	–	75	100	3RW44 35- □ BC □ 6
	162	–	90	110	160	145	–	–	100	125	3RW44 36- □ BC □ 6
	203	–	110	132	200	180	–	–	125	150	3RW44 43- □ BC □ 6
	250	–	132	160	250	215	–	–	150	200	3RW44 44- □ BC □ 6
	313	–	160	200	315	280	–	–	200	250	3RW44 45- □ BC □ 6
	356	–	200	250	355	315	–	–	250	300	3RW44 46- □ BC □ 6
	432	–	250	315	400	385	–	–	300	400	3RW44 47- □ BC □ 6
	551	–	315	355	560	494	–	–	400	500	3RW44 53- □ BC □ 6
	615	–	355	400	630	551	–	–	450	600	3RW44 54- □ BC □ 6
	693	–	400	500	710	615	–	–	500	700	3RW44 55- □ BC □ 6
	780	–	450	560	800	693	–	–	600	750	3RW44 56- □ BC □ 6
	880	–	500	630	900	780	–	–	700	850	3RW44 57- □ BC □ 6
	970	–	560	710	1000	850	–	–	750	900	3RW44 58- □ BC □ 6
	1076	–	630	800	1100	970	–	–	850	1100	3RW44 65- □ BC □ 6
	1214	–	710	900	1200	1076	–	–	950	1200	3RW44 66- □ BC □ 6
Order No. supplement for connection type											
Spring-loaded terminals											
Screw-type terminals											
AC 115 V											
AC 230 V											





# SIRIUS 3RW44

## for heavy-duty starting (CLASS 20)

### in standard circuit

Rated operating voltage $U_e$		Rated operating current $I_e$				Rated power of three-phase motors with rated operating voltage $U_e$				Rated operating current $I_e$		Rated power of three-phase motors with rated operating voltage $U_e$				Order No.											
Ambient temperature 40 °C												Ambient temperature 50 °C															
V	A	230 V kW	400 V kW	500 V kW	690 V kW	A	200 V hp	230 V hp	460 V hp	575 V hp																	
200 ... 460	29	5.5	15	–	–	26	7.5	7.5	15	–	3RW44 22- <input type="checkbox"/> BC <input type="checkbox"/> 4																
	36	7.5	18.5	–	–	32	10	10	20	–	3RW44 23- <input type="checkbox"/> BC <input type="checkbox"/> 4																
	47	11	22	–	–	42	10	15	25	–	3RW44 24- <input type="checkbox"/> BC <input type="checkbox"/> 4																
	57	15	30	–	–	51	15	15	30	–	3RW44 25- <input type="checkbox"/> BC <input type="checkbox"/> 4																
	77	18.5	37	–	–	68	20	20	50	–	3RW44 27- <input type="checkbox"/> BC <input type="checkbox"/> 4																
400 ... 600	29	–	15	18.5	–	26	–	–	15	20	3RW44 22- <input type="checkbox"/> BC <input type="checkbox"/> 5																
	36	–	18.5	22	–	32	–	–	20	25	3RW44 23- <input type="checkbox"/> BC <input type="checkbox"/> 5																
	47	–	22	30	–	42	–	–	25	30	3RW44 24- <input type="checkbox"/> BC <input type="checkbox"/> 5																
	57	–	30	37	–	51	–	–	30	40	3RW44 25- <input type="checkbox"/> BC <input type="checkbox"/> 5																
	77	–	37	45	–	68	–	–	50	50	3RW44 27- <input type="checkbox"/> BC <input type="checkbox"/> 5																
400 ... 690	29	–	15	18.5	30	26	–	–	15	20	3RW44 22- <input type="checkbox"/> BC <input type="checkbox"/> 6																
	36	–	18.5	22	37	32	–	–	20	25	3RW44 23- <input type="checkbox"/> BC <input type="checkbox"/> 6																
	47	–	22	30	45	42	–	–	25	30	3RW44 24- <input type="checkbox"/> BC <input type="checkbox"/> 6																
	57	–	30	37	55	51	–	–	30	40	3RW44 25- <input type="checkbox"/> BC <input type="checkbox"/> 6																
	77	–	37	45	75	68	–	–	50	50	3RW44 27- <input type="checkbox"/> BC <input type="checkbox"/> 6																
Order No. supplement for connection type											Screw-type terminals Spring-loaded terminals				1 3												
200 ... 460	93	22	45	–	–	82	25	25	60	–	3RW44 34- <input type="checkbox"/> BC <input type="checkbox"/> 4																
	113	30	55	–	–	100	30	30	75	–	3RW44 35- <input type="checkbox"/> BC <input type="checkbox"/> 4																
	134	37	75	–	–	117	30	40	75	–	3RW44 36- <input type="checkbox"/> BC <input type="checkbox"/> 4																
	162	45	90	–	–	145	40	50	100	–	3RW44 43- <input type="checkbox"/> BC <input type="checkbox"/> 4																
	203	55	110	–	–	180	50	60	125	–	3RW44 45- <input type="checkbox"/> BC <input type="checkbox"/> 4																
	250	75	132	–	–	215	60	75	150	–	3RW44 46- <input type="checkbox"/> BC <input type="checkbox"/> 4																
	313	90	160	–	–	280	75	100	200	–	3RW44 47- <input type="checkbox"/> BC <input type="checkbox"/> 4																
	356	110	200	–	–	315	100	125	250	–	3RW44 47- <input type="checkbox"/> BC <input type="checkbox"/> 4																
	432	132	250	–	–	385	125	150	300	–	3RW44 53- <input type="checkbox"/> BC <input type="checkbox"/> 4																
	551	160	315	–	–	494	150	200	400	–	3RW44 53- <input type="checkbox"/> BC <input type="checkbox"/> 4																
	615	200	355	–	–	551	150	200	450	–	3RW44 55- <input type="checkbox"/> BC <input type="checkbox"/> 4																
	693	200	400	–	–	615	200	250	500	–	3RW44 57- <input type="checkbox"/> BC <input type="checkbox"/> 4																
	780	250	450	–	–	693	200	250	600	–	3RW44 65- <input type="checkbox"/> BC <input type="checkbox"/> 4																
	880	250	500	–	–	780	250	300	700	–	3RW44 65- <input type="checkbox"/> BC <input type="checkbox"/> 4																
	970	315	560	–	–	850	300	350	750	–	3RW44 65- <input type="checkbox"/> BC <input type="checkbox"/> 4																
400 ... 600	93	–	45	55	–	82	–	–	60	75	3RW44 34- <input type="checkbox"/> BC <input type="checkbox"/> 5																
	113	–	55	75	–	100	–	–	75	75	3RW44 35- <input type="checkbox"/> BC <input type="checkbox"/> 5																
	134	–	75	90	–	117	–	–	75	100	3RW44 36- <input type="checkbox"/> BC <input type="checkbox"/> 5																
	162	–	90	110	–	145	–	–	100	125	3RW44 43- <input type="checkbox"/> BC <input type="checkbox"/> 5																
	203	–	110	132	–	180	–	–	125	150	3RW44 45- <input type="checkbox"/> BC <input type="checkbox"/> 5																
	250	–	132	160	–	215	–	–	150	200	3RW44 46- <input type="checkbox"/> BC <input type="checkbox"/> 5																
	313	–	160	200	–	280	–	–	200	250	3RW44 47- <input type="checkbox"/> BC <input type="checkbox"/> 5																
	356	–	200	250	–	315	–	–	250	300	3RW44 47- <input type="checkbox"/> BC <input type="checkbox"/> 5																
	432	–	250	315	–	385	–	–	300	400	3RW44 53- <input type="checkbox"/> BC <input type="checkbox"/> 5																
	551	–	315	355	–	494	–	–	400	500	3RW44 53- <input type="checkbox"/> BC <input type="checkbox"/> 5																
	615	–	355	400	–	551	–	–	450	600	3RW44 54- <input type="checkbox"/> BC <input type="checkbox"/> 5																
	693	–	400	500	–	615	–	–	500	700	3RW44 57- <input type="checkbox"/> BC <input type="checkbox"/> 5																
	780	–	450	560	–	693	–	–	600	750	3RW44 65- <input type="checkbox"/> BC <input type="checkbox"/> 5																
	880	–	500	630	–	780	–	–	700	850	3RW44 65- <input type="checkbox"/> BC <input type="checkbox"/> 5																
	970	–	560	710	–	850	–	–	750	900	3RW44 65- <input type="checkbox"/> BC <input type="checkbox"/> 5																
400 ... 690	93	–	45	55	90	82	–	–	60	75	3RW44 34- <input type="checkbox"/> BC <input type="checkbox"/> 6																
	113	–	55	75	110	100	–	–	75	75	3RW44 35- <input type="checkbox"/> BC <input type="checkbox"/> 6																
	134	–	75	90	132	117	–	–	75	100	3RW44 36- <input type="checkbox"/> BC <input type="checkbox"/> 6																
	162	–	90	110	160	145	–	–	100	125	3RW44 43- <input type="checkbox"/> BC <input type="checkbox"/> 6																
	203	–	110	132	200	180	–	–	125	150	3RW44 45- <input type="checkbox"/> BC <input type="checkbox"/> 6																
	250	–	132	160	250	215	–	–	150	200	3RW44 46- <input type="checkbox"/> BC <input type="checkbox"/> 6																
	313	–	160	200	315	280	–	–	200	250	3RW44 47- <input type="checkbox"/> BC <input type="checkbox"/> 6																
	356	–	200	250	355	315	–	–	250	300	3RW44 47- <input type="checkbox"/> BC <input type="checkbox"/> 6																
	432	–	250	315	400	385	–	–	300	400	3RW44 53- <input type="checkbox"/> BC <input type="checkbox"/> 6																
	551	–	315	355	560	494	–	–	400	500	3RW44 53- <input type="checkbox"/> BC <input type="checkbox"/> 6																
	615	–	355	400	630	551	–	–	450	600	3RW44 55- <input type="checkbox"/> BC <input type="checkbox"/> 6																
	693	–	400	500	710	615	–	–	500	700	3RW44 57- <input type="checkbox"/> BC <input type="checkbox"/> 6																
	780	–	450	560	800	693	–	–	600	750	3RW44 65- <input type="checkbox"/> BC <input type="checkbox"/> 6																
	880	–	500	630	900	780	–	–	700	850	3RW44 65- <input type="checkbox"/> BC <input type="checkbox"/> 6																
	970	–	560	710	1000	850	–	–	750	900	3RW44 65- <input type="checkbox"/> BC <input type="checkbox"/> 6																
Order No. supplement for connection type											Spring-loaded terminals Screw-type terminals				2 6												
Order No. supplement for rated control supply voltage $U_s$											AC 115 V AC 230 V				3 4												

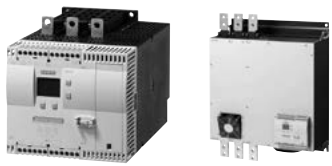

# SIRIUS 3RW44

## for ultra-heavy-duty starting (CLASS 30) in standard circuit

Rated operating voltage $U_e$		Rated power of three-phase motors with rated operating voltage $U_e$				Rated operating current $I_e$		Rated power of three-phase motors with rated operating voltage $U_e$					Order No.
		Ambient temperature 40 °C						Ambient temperature 50 °C					
V	A	230 V kW	400 V kW	500 V kW	690 V kW	A	200 V hp	230 V hp	460 V hp	575 V hp			
200 ... 460	29	5.5	15	–	–	26	7.5	7.5	15	–	3RW44 22-	<input type="checkbox"/> BC <input type="checkbox"/> 4	
	36	7.5	18.5	–	–	32	10	10	20	–	3RW44 24-	<input type="checkbox"/> BC <input type="checkbox"/> 4	
	47	11	22	–	–	42	10	15	25	–	3RW44 25-	<input type="checkbox"/> BC <input type="checkbox"/> 4	
	57	15	30	–	–	51	15	15	30	–	3RW44 25-	<input type="checkbox"/> BC <input type="checkbox"/> 4	
400 ... 600	29	–	15	18.5	–	26	–	–	15	20	3RW44 22-	<input type="checkbox"/> BC <input type="checkbox"/> 5	
	36	–	18.5	22	–	32	–	–	20	25	3RW44 24-	<input type="checkbox"/> BC <input type="checkbox"/> 5	
	47	–	22	30	–	42	–	–	25	30	3RW44 25-	<input type="checkbox"/> BC <input type="checkbox"/> 5	
	57	–	30	37	–	51	–	–	30	40	3RW44 25-	<input type="checkbox"/> BC <input type="checkbox"/> 5	
400 ... 690	29	–	15	18.5	30	26	–	–	15	20	3RW44 22-	<input type="checkbox"/> BC <input type="checkbox"/> 6	
	36	–	18.5	22	37	32	–	–	20	25	3RW44 24-	<input type="checkbox"/> BC <input type="checkbox"/> 6	
	47	–	22	30	45	42	–	–	25	30	3RW44 25-	<input type="checkbox"/> BC <input type="checkbox"/> 6	
	57	–	30	37	55	51	–	–	30	40	3RW44 25-	<input type="checkbox"/> BC <input type="checkbox"/> 6	
Order No. supplement for connection type										Screw-type terminals Spring-loaded terminals		1 3	
200 ... 460	77	18.5	37	–	–	68	20	20	50	–	3RW44 34-	<input type="checkbox"/> BC <input type="checkbox"/> 4	
	93	22	45	–	–	82	25	25	60	–	3RW44 35-	<input type="checkbox"/> BC <input type="checkbox"/> 4	
	113	30	55	–	–	100	30	30	75	–	3RW44 43-	<input type="checkbox"/> BC <input type="checkbox"/> 4	
	134	37	77	–	–	117	30	40	75	–	3RW44 43-	<input type="checkbox"/> BC <input type="checkbox"/> 4	
	162	45	90	–	–	145	40	50	100	–	3RW44 43-	<input type="checkbox"/> BC <input type="checkbox"/> 4	
	203	55	110	–	–	180	50	60	125	–	3RW44 46-	<input type="checkbox"/> BC <input type="checkbox"/> 4	
	250	75	132	–	–	215	60	75	150	–	3RW44 47-	<input type="checkbox"/> BC <input type="checkbox"/> 4	
	313	90	160	–	–	280	75	100	200	–	3RW44 53-	<input type="checkbox"/> BC <input type="checkbox"/> 4	
	356	110	200	–	–	315	100	125	250	–	3RW44 53-	<input type="checkbox"/> BC <input type="checkbox"/> 4	
	432	132	250	–	–	385	125	150	300	–	3RW44 53-	<input type="checkbox"/> BC <input type="checkbox"/> 4	
	551	160	315	–	–	494	150	200	400	–	3RW44 55-	<input type="checkbox"/> BC <input type="checkbox"/> 4	
	615	200	355	–	–	551	150	200	450	–	3RW44 58-	<input type="checkbox"/> BC <input type="checkbox"/> 4	
	693	200	400	–	–	615	200	250	500	–	3RW44 65-	<input type="checkbox"/> BC <input type="checkbox"/> 4	
	780	250	450	–	–	693	200	250	600	–	3RW44 65-	<input type="checkbox"/> BC <input type="checkbox"/> 4	
880	250	500	–	–	780	250	300	700	–	3RW44 65-	<input type="checkbox"/> BC <input type="checkbox"/> 4		
970	315	560	–	–	850	300	350	750	–	3RW44 66-	<input type="checkbox"/> BC <input type="checkbox"/> 4		
400 ... 600	77	–	37	45	–	68	–	–	50	50	3RW44 34-	<input type="checkbox"/> BC <input type="checkbox"/> 5	
	93	–	45	55	–	82	–	–	60	75	3RW44 35-	<input type="checkbox"/> BC <input type="checkbox"/> 5	
	113	–	55	75	–	100	–	–	75	75	3RW44 43-	<input type="checkbox"/> BC <input type="checkbox"/> 5	
	134	–	77	90	–	117	–	–	75	100	3RW44 43-	<input type="checkbox"/> BC <input type="checkbox"/> 5	
	162	–	90	110	–	145	–	–	100	125	3RW44 43-	<input type="checkbox"/> BC <input type="checkbox"/> 5	
	203	–	110	132	–	180	–	–	125	150	3RW44 46-	<input type="checkbox"/> BC <input type="checkbox"/> 5	
	250	–	132	160	–	215	–	–	150	200	3RW44 47-	<input type="checkbox"/> BC <input type="checkbox"/> 5	
	313	–	160	200	–	280	–	–	200	250	3RW44 53-	<input type="checkbox"/> BC <input type="checkbox"/> 5	
	356	–	200	250	–	315	–	–	250	300	3RW44 53-	<input type="checkbox"/> BC <input type="checkbox"/> 5	
	432	–	250	315	–	385	–	–	300	400	3RW44 53-	<input type="checkbox"/> BC <input type="checkbox"/> 5	
	551	–	315	355	–	494	–	–	400	500	3RW44 55-	<input type="checkbox"/> BC <input type="checkbox"/> 5	
	615	–	355	400	–	551	–	–	450	600	3RW44 58-	<input type="checkbox"/> BC <input type="checkbox"/> 5	
	693	–	400	500	–	615	–	–	500	700	3RW44 65-	<input type="checkbox"/> BC <input type="checkbox"/> 5	
	780	–	450	560	–	693	–	–	600	750	3RW44 65-	<input type="checkbox"/> BC <input type="checkbox"/> 5	
880	–	500	630	–	780	–	–	700	850	3RW44 65-	<input type="checkbox"/> BC <input type="checkbox"/> 5		
–	–	–	–	–	850	–	–	750	900	3RW44 66-	<input type="checkbox"/> BC <input type="checkbox"/> 5		
400 ... 690	77	–	37	45	75	68	–	–	50	50	3RW44 34-	<input type="checkbox"/> BC <input type="checkbox"/> 6	
	93	–	45	55	90	82	–	–	60	75	3RW44 35-	<input type="checkbox"/> BC <input type="checkbox"/> 6	
	113	–	55	75	110	100	–	–	75	75	3RW44 43-	<input type="checkbox"/> BC <input type="checkbox"/> 6	
	134	–	77	90	132	117	–	–	75	100	3RW44 43-	<input type="checkbox"/> BC <input type="checkbox"/> 6	
	162	–	90	110	160	145	–	–	100	125	3RW44 43-	<input type="checkbox"/> BC <input type="checkbox"/> 6	
	203	–	110	132	200	180	–	–	125	150	3RW44 46-	<input type="checkbox"/> BC <input type="checkbox"/> 6	
	250	–	132	160	250	215	–	–	150	200	3RW44 47-	<input type="checkbox"/> BC <input type="checkbox"/> 6	
	313	–	160	200	315	280	–	–	200	250	3RW44 53-	<input type="checkbox"/> BC <input type="checkbox"/> 6	
	356	–	200	250	355	315	–	–	250	300	3RW44 53-	<input type="checkbox"/> BC <input type="checkbox"/> 6	
	432	–	250	315	400	385	–	–	300	400	3RW44 53-	<input type="checkbox"/> BC <input type="checkbox"/> 6	
	551	–	315	355	560	494	–	–	400	500	3RW44 55-	<input type="checkbox"/> BC <input type="checkbox"/> 6	
	615	–	355	400	630	551	–	–	450	600	3RW44 58-	<input type="checkbox"/> BC <input type="checkbox"/> 6	
	693	–	400	500	710	615	–	–	500	700	3RW44 65-	<input type="checkbox"/> BC <input type="checkbox"/> 6	
	780	–	450	560	800	693	–	–	600	750	3RW44 65-	<input type="checkbox"/> BC <input type="checkbox"/> 6	
880	–	500	630	900	780	–	–	700	850	3RW44 65-	<input type="checkbox"/> BC <input type="checkbox"/> 6		
–	–	–	–	–	850	–	–	750	900	3RW44 66-	<input type="checkbox"/> BC <input type="checkbox"/> 6		
Order No. supplement for connection type										Spring-loaded terminals Screw-type terminals		2 6	
Order No. supplement for rated control supply voltage $U_s$										AC 115 V AC 230 V		3 4	



# SIRIUS 3RW44 for normal starting (CLASS 10) in inside-delta circuit

Rated operating voltage $U_e$	Rated operating current $I_e$	Rated power of three-phase motors with rated operating voltage $U_e$				Rated operating current $I_e$	Rated power of three-phase motors with rated operating voltage $U_e$				Order No.	
Ambient temperature 40 °C						Ambient temperature 50 °C						
V	A	230 V kW	400 V kW	500 V kW	690 V kW	A	200 V hp	230 V hp	460 V hp	575 V hp		
200 ... 460	50	15	22	–	–	45	10	15	30	–	3RW44 22- <input type="checkbox"/> BC <input type="checkbox"/> 4	
	62	18.5	30	–	–	55	15	20	40	–	3RW44 23- <input type="checkbox"/> BC <input type="checkbox"/> 4	
	81	22	45	–	–	73	20	25	50	–	3RW44 24- <input type="checkbox"/> BC <input type="checkbox"/> 4	
	99	30	55	–	–	88	25	30	60	–	3RW44 25- <input type="checkbox"/> BC <input type="checkbox"/> 4	
	133	37	75	–	–	118	30	40	75	–	3RW44 26- <input type="checkbox"/> BC <input type="checkbox"/> 4	
	161	45	90	–	–	142	40	50	100	–	3RW44 27- <input type="checkbox"/> BC <input type="checkbox"/> 4	
400 ... 600	50	–	22	30	–	45	–	–	30	40	3RW44 22- <input type="checkbox"/> BC <input type="checkbox"/> 5	
	62	–	30	37	–	55	–	–	40	50	3RW44 23- <input type="checkbox"/> BC <input type="checkbox"/> 5	
	81	–	45	45	–	73	–	–	50	60	3RW44 24- <input type="checkbox"/> BC <input type="checkbox"/> 5	
	99	–	55	55	–	88	–	–	60	75	3RW44 25- <input type="checkbox"/> BC <input type="checkbox"/> 5	
	133	–	75	90	–	118	–	–	75	100	3RW44 26- <input type="checkbox"/> BC <input type="checkbox"/> 5	
	161	–	90	110	–	142	–	–	100	125	3RW44 27- <input type="checkbox"/> BC <input type="checkbox"/> 5	
Order No. supplement for connection type										Screw-type terminals Spring-loaded terminals		↑ 1 3
200 ... 460	196	55	110	–	–	173	50	60	125	–	3RW44 34- <input type="checkbox"/> BC <input type="checkbox"/> 4	
	232	75	132	–	–	203	60	75	150	–	3RW44 35- <input type="checkbox"/> BC <input type="checkbox"/> 4	
	281	90	160	–	–	251	75	100	200	–	3RW44 36- <input type="checkbox"/> BC <input type="checkbox"/> 4	
	352	110	200	–	–	312	100	125	250	–	3RW44 43- <input type="checkbox"/> BC <input type="checkbox"/> 4	
	433	132	250	–	–	372	125	150	300	–	3RW44 44- <input type="checkbox"/> BC <input type="checkbox"/> 4	
	542	160	315	–	–	485	150	200	400	–	3RW44 45- <input type="checkbox"/> BC <input type="checkbox"/> 4	
	617	200	355	–	–	546	150	200	450	–	3RW44 46- <input type="checkbox"/> BC <input type="checkbox"/> 4	
	748	250	400	–	–	667	200	250	600	–	3RW44 47- <input type="checkbox"/> BC <input type="checkbox"/> 4	
	954	315	560	–	–	856	300	350	750	–	3RW44 53- <input type="checkbox"/> BC <input type="checkbox"/> 4	
	1065	355	630	–	–	954	350	400	850	–	3RW44 54- <input type="checkbox"/> BC <input type="checkbox"/> 4	
	1200	400	710	–	–	1065	350	450	950	–	3RW44 55- <input type="checkbox"/> BC <input type="checkbox"/> 4	
	1351	450	800	–	–	1200	450	500	1050	–	3RW44 56- <input type="checkbox"/> BC <input type="checkbox"/> 4	
	1524	500	900	–	–	1351	450	600	1200	–	3RW44 57- <input type="checkbox"/> BC <input type="checkbox"/> 4	
	1680	560	1000	–	–	1472	550	650	1300	–	3RW44 58- <input type="checkbox"/> BC <input type="checkbox"/> 4	
	1864	630	1100	–	–	1680	650	750	1500	–	3RW44 65- <input type="checkbox"/> BC <input type="checkbox"/> 4	
	2103	710	1200	–	–	1864	700	850	1700	–	3RW44 66- <input type="checkbox"/> BC <input type="checkbox"/> 4	
400 ... 600	196	–	110	132	–	173	–	–	125	150	3RW44 34- <input type="checkbox"/> BC <input type="checkbox"/> 5	
	232	–	132	160	–	203	–	–	150	200	3RW44 35- <input type="checkbox"/> BC <input type="checkbox"/> 5	
	281	–	160	200	–	251	–	–	200	250	3RW44 36- <input type="checkbox"/> BC <input type="checkbox"/> 5	
	352	–	200	250	–	312	–	–	250	300	3RW44 43- <input type="checkbox"/> BC <input type="checkbox"/> 5	
	433	–	250	315	–	372	–	–	300	350	3RW44 44- <input type="checkbox"/> BC <input type="checkbox"/> 5	
	542	–	315	355	–	485	–	–	400	500	3RW44 45- <input type="checkbox"/> BC <input type="checkbox"/> 5	
	617	–	355	450	–	546	–	–	450	600	3RW44 46- <input type="checkbox"/> BC <input type="checkbox"/> 5	
	748	–	400	500	–	667	–	–	600	750	3RW44 47- <input type="checkbox"/> BC <input type="checkbox"/> 5	
	954	–	560	630	–	856	–	–	750	950	3RW44 53- <input type="checkbox"/> BC <input type="checkbox"/> 5	
	1065	–	630	710	–	954	–	–	850	1050	3RW44 54- <input type="checkbox"/> BC <input type="checkbox"/> 5	
	1200	–	710	800	–	1065	–	–	950	1200	3RW44 55- <input type="checkbox"/> BC <input type="checkbox"/> 5	
	1351	–	800	900	–	1200	–	–	1050	1350	3RW44 56- <input type="checkbox"/> BC <input type="checkbox"/> 5	
	1524	–	900	1000	–	1351	–	–	1200	1500	3RW44 57- <input type="checkbox"/> BC <input type="checkbox"/> 5	
	1680	–	1000	1200	–	1472	–	–	1300	1650	3RW44 58- <input type="checkbox"/> BC <input type="checkbox"/> 5	
	1864	–	1100	1350	–	1680	–	–	1500	1900	3RW44 65- <input type="checkbox"/> BC <input type="checkbox"/> 5	
	2103	–	1200	1500	–	1864	–	–	1700	2100	3RW44 66- <input type="checkbox"/> BC <input type="checkbox"/> 5	
Order No. supplement for connection type										Spring-loaded terminals Screw-type terminals		↑ 2 6
Order No. supplement for rated control supply voltage $U_s$										AC 115 V AC 230 V		↑ 3 4



# SIRIUS 3RW44

## for heavy-duty starting (CLASS 20)

### in inside-delta circuit

Rated operating voltage $U_e$		Rated operating current $I_e$				Rated power of three-phase motors with rated operating voltage $U_e$				Rated operating current $I_e$		Rated power of three-phase motors with rated operating voltage $U_e$				Order No.															
Ambient temperature 40 °C																Ambient temperature 50 °C															
V	A	230 V kW	400 V kW	500 V kW	690 V kW	A	200 V hp	230 V hp	460 V hp	575 V hp																					
200 ... 460	50	15	22	–	–	45	10	15	30	–						3RW44 23- <input type="checkbox"/> BC <input type="checkbox"/> 4															
	62	18.5	30	–	–	55	15	20	40	–						3RW44 24- <input type="checkbox"/> BC <input type="checkbox"/> 4															
	81	22	45	–	–	73	20	25	50	–						3RW44 25- <input type="checkbox"/> BC <input type="checkbox"/> 4															
	99	30	55	–	–	88	25	30	60	–						3RW44 25- <input type="checkbox"/> BC <input type="checkbox"/> 4															
	133	37	75	–	–	118	30	40	75	–						3RW44 27- <input type="checkbox"/> BC <input type="checkbox"/> 4															
400 ... 600	50	–	22	30	–	45	–	–	30	40						3RW44 23- <input type="checkbox"/> BC <input type="checkbox"/> 5															
	62	–	30	37	–	55	–	–	40	50						3RW44 24- <input type="checkbox"/> BC <input type="checkbox"/> 5															
	81	–	45	45	–	73	–	–	50	60						3RW44 25- <input type="checkbox"/> BC <input type="checkbox"/> 5															
	99	–	55	55	–	88	–	–	60	75						3RW44 25- <input type="checkbox"/> BC <input type="checkbox"/> 5															
	133	–	75	90	–	118	–	–	75	100						3RW44 27- <input type="checkbox"/> BC <input type="checkbox"/> 5															
Order No. supplement for connection type											Screw-type terminals					Spring-loaded terminals					1										
																					3										
200 ... 460	161	45	90	–	–	142	40	50	100	–						3RW44 34- <input type="checkbox"/> BC <input type="checkbox"/> 4															
	196	55	110	–	–	173	50	60	125	–						3RW44 35- <input type="checkbox"/> BC <input type="checkbox"/> 4															
	232	75	132	–	–	203	60	75	150	–						3RW44 36- <input type="checkbox"/> BC <input type="checkbox"/> 4															
	281	90	160	–	–	251	75	100	200	–						3RW44 43- <input type="checkbox"/> BC <input type="checkbox"/> 4															
	352	110	200	–	–	312	100	125	250	–						3RW44 44- <input type="checkbox"/> BC <input type="checkbox"/> 4															
	433	132	250	–	–	372	125	150	300	–						3RW44 45- <input type="checkbox"/> BC <input type="checkbox"/> 4															
	542	160	315	–	–	485	150	200	400	–						3RW44 47- <input type="checkbox"/> BC <input type="checkbox"/> 4															
	617	200	355	–	–	546	150	200	450	–						3RW44 47- <input type="checkbox"/> BC <input type="checkbox"/> 4															
	748	250	400	–	–	667	200	250	600	–						3RW44 53- <input type="checkbox"/> BC <input type="checkbox"/> 4															
	954	315	560	–	–	856	300	350	750	–						3RW44 53- <input type="checkbox"/> BC <input type="checkbox"/> 4															
	1065	355	630	–	–	954	350	400	850	–						3RW44 55- <input type="checkbox"/> BC <input type="checkbox"/> 4															
	1200	400	710	–	–	1065	350	450	950	–						3RW44 57- <input type="checkbox"/> BC <input type="checkbox"/> 4															
	1351	450	800	–	–	1200	450	500	1050	–						3RW44 65- <input type="checkbox"/> BC <input type="checkbox"/> 4															
	1524	500	900	–	–	1351	450	600	1200	–						3RW44 65- <input type="checkbox"/> BC <input type="checkbox"/> 4															
	1680	560	1000	–	–	1472	550	650	1300	–						3RW44 65- <input type="checkbox"/> BC <input type="checkbox"/> 4															
–	–	–	–	–	1680	650	750	1500	–						3RW44 66- <input type="checkbox"/> BC <input type="checkbox"/> 4																
400 ... 600	196	–	90	110	–	142	–	–	100	125						3RW44 34- <input type="checkbox"/> BC <input type="checkbox"/> 5															
	232	–	110	132	–	173	–	–	125	150						3RW44 35- <input type="checkbox"/> BC <input type="checkbox"/> 5															
	281	–	132	160	–	203	–	–	150	200						3RW44 36- <input type="checkbox"/> BC <input type="checkbox"/> 5															
	281	–	160	200	–	251	–	–	200	250						3RW44 43- <input type="checkbox"/> BC <input type="checkbox"/> 5															
	352	–	200	250	–	312	–	–	250	300						3RW44 44- <input type="checkbox"/> BC <input type="checkbox"/> 5															
	433	–	250	315	–	372	–	–	300	350						3RW44 45- <input type="checkbox"/> BC <input type="checkbox"/> 5															
	542	–	315	355	–	485	–	–	400	500						3RW44 47- <input type="checkbox"/> BC <input type="checkbox"/> 5															
	617	–	355	450	–	546	–	–	450	600						3RW44 47- <input type="checkbox"/> BC <input type="checkbox"/> 5															
	748	–	400	500	–	667	–	–	600	750						3RW44 53- <input type="checkbox"/> BC <input type="checkbox"/> 5															
	954	–	560	630	–	856	–	–	750	950						3RW44 53- <input type="checkbox"/> BC <input type="checkbox"/> 5															
	1065	–	630	710	–	954	–	–	850	1050						3RW44 55- <input type="checkbox"/> BC <input type="checkbox"/> 5															
	1200	–	710	800	–	1065	–	–	950	1200						3RW44 57- <input type="checkbox"/> BC <input type="checkbox"/> 5															
	1351	–	800	900	–	1200	–	–	1050	1350						3RW44 65- <input type="checkbox"/> BC <input type="checkbox"/> 5															
	1472	–	900	1000	–	1351	–	–	1200	1500						3RW44 65- <input type="checkbox"/> BC <input type="checkbox"/> 5															
	1680	–	1000	1200	–	1472	–	–	1300	1650						3RW44 65- <input type="checkbox"/> BC <input type="checkbox"/> 5															
–	–	–	–	–	1680	–	–	1500	1900						3RW44 66- <input type="checkbox"/> BC <input type="checkbox"/> 5																
Order No. supplement for connection type											Spring-loaded terminals					Screw-type terminals					2										
Order No. supplement for rated control supply voltage $U_s$											AC 115 V					AC 230 V					3										
																					4										

Please observe the configuration notes and boundary conditions on page 14 and 15!



# SIRIUS 3RW44

## for ultra-heavy-duty starting (CLASS 30) in inside-delta circuit

Rated operating voltage <i>U<sub>e</sub></i>	Rated operating current <i>I<sub>e</sub></i>	Rated power of three-phase motors with rated operating voltage <i>U<sub>e</sub></i>				Rated operating current <i>I<sub>e</sub></i>	Rated power of three-phase motors with rated operating voltage <i>U<sub>e</sub></i>				Order No.	
		230 V kW	400 V kW	500 V kW	690 V kW		200 V hp	230 V hp	460 V hp	575 V hp		
Ambient temperature 40 °C						Ambient temperature 50 °C						
<b>V</b>	<b>A</b>	<b>230 V kW</b>	<b>400 V kW</b>	<b>500 V kW</b>	<b>690 V kW</b>	<b>A</b>	<b>200 V hp</b>	<b>230 V hp</b>	<b>460 V hp</b>	<b>575 V hp</b>		
<b>200 ... 460</b>	50 62 81 99 133	15 18.5 22 30 37	22 30 45 55 75	– – – – –	– – – – –	45 55 73 88 118	10 15 20 25 30	15 20 25 30 40	30 40 50 60 75	– – – – –	3RW44 23- <input type="checkbox"/> BC <input type="checkbox"/> 4 3RW44 24- <input type="checkbox"/> BC <input type="checkbox"/> 4 3RW44 25- <input type="checkbox"/> BC <input type="checkbox"/> 4 3RW44 25- <input type="checkbox"/> BC <input type="checkbox"/> 4 3RW44 27- <input type="checkbox"/> BC <input type="checkbox"/> 4	
<b>400 ... 600</b>	50 62 81 99 133	– – – – –	22 30 45 55 75	30 37 45 55 90	– – – – –	45 55 73 88 118	– – – – –	– – – – –	30 40 50 60 75	40 50 60 75 100	3RW44 23- <input type="checkbox"/> BC <input type="checkbox"/> 5 3RW44 24- <input type="checkbox"/> BC <input type="checkbox"/> 5 3RW44 25- <input type="checkbox"/> BC <input type="checkbox"/> 5 3RW44 25- <input type="checkbox"/> BC <input type="checkbox"/> 5 3RW44 27- <input type="checkbox"/> BC <input type="checkbox"/> 5	
<b>Order No. supplement for connection type</b>											↑ 1 3 ↑	
<b>200 ... 460</b>	161 196 232 281 352 433 542 617 748 954 1065 1200 1351 1524 –	45 55 75 90 110 132 160 200 250 315 355 400 450 500 –	90 110 132 160 200 250 315 355 400 560 630 710 800 900 –	– – – – – – – – – – – – – – –	– – – – – – – – – – – – – – –	142 173 203 251 312 372 485 546 667 856 954 1065 1200 1351 1472	40 50 60 75 100 125 150 200 250 300 350 400 450 500 600 650	50 60 75 100 125 150 200 200 250 350 400 450 500 600 650	100 125 150 200 250 300 400 450 600 750 850 950 1050 1200 1300	– – – – – – – – – – – – – – –	3RW44 35- <input type="checkbox"/> BC <input type="checkbox"/> 4 3RW44 36- <input type="checkbox"/> BC <input type="checkbox"/> 4 3RW44 43- <input type="checkbox"/> BC <input type="checkbox"/> 4 3RW44 43- <input type="checkbox"/> BC <input type="checkbox"/> 4 3RW44 45- <input type="checkbox"/> BC <input type="checkbox"/> 4 3RW44 47- <input type="checkbox"/> BC <input type="checkbox"/> 4 3RW44 53- <input type="checkbox"/> BC <input type="checkbox"/> 4 3RW44 53- <input type="checkbox"/> BC <input type="checkbox"/> 4 3RW44 53- <input type="checkbox"/> BC <input type="checkbox"/> 4 3RW44 55- <input type="checkbox"/> BC <input type="checkbox"/> 4 3RW44 58- <input type="checkbox"/> BC <input type="checkbox"/> 4 3RW44 65- <input type="checkbox"/> BC <input type="checkbox"/> 4 3RW44 65- <input type="checkbox"/> BC <input type="checkbox"/> 4 3RW44 65- <input type="checkbox"/> BC <input type="checkbox"/> 4 3RW44 66- <input type="checkbox"/> BC <input type="checkbox"/> 4	
<b>400 ... 600</b>	161 196 232 281 352 433 542 617 748 954 1065 1200 1351 1524 –	– – – – – – – – – – – – – – –	90 110 132 160 200 250 315 355 400 560 630 710 800 900 1000 –	110 132 160 200 250 315 355 450 500 630 710 800 900 1000 –	– – – – – – – – – – – – – – –	142 173 203 251 312 372 485 546 667 856 954 1065 1200 1351 1472	– – – – – – – – – – – – – – –	– – – – – – – – – – – – – – –	100 125 150 200 250 300 350 400 450 600 750 850 950 1050 1200 1350 1500 1650	125 150 200 250 300 350 500 600 750 950 1050 1200 1350 1500 1650	3RW44 35- <input type="checkbox"/> BC <input type="checkbox"/> 5 3RW44 36- <input type="checkbox"/> BC <input type="checkbox"/> 5 3RW44 43- <input type="checkbox"/> BC <input type="checkbox"/> 5 3RW44 43- <input type="checkbox"/> BC <input type="checkbox"/> 5 3RW44 45- <input type="checkbox"/> BC <input type="checkbox"/> 5 3RW44 47- <input type="checkbox"/> BC <input type="checkbox"/> 5 3RW44 53- <input type="checkbox"/> BC <input type="checkbox"/> 5 3RW44 53- <input type="checkbox"/> BC <input type="checkbox"/> 5 3RW44 53- <input type="checkbox"/> BC <input type="checkbox"/> 5 3RW44 55- <input type="checkbox"/> BC <input type="checkbox"/> 5 3RW44 58- <input type="checkbox"/> BC <input type="checkbox"/> 5 3RW44 65- <input type="checkbox"/> BC <input type="checkbox"/> 5 3RW44 65- <input type="checkbox"/> BC <input type="checkbox"/> 5 3RW44 65- <input type="checkbox"/> BC <input type="checkbox"/> 5 3RW44 66- <input type="checkbox"/> BC <input type="checkbox"/> 5	
<b>Order No. supplement for connection type</b>											↑ 2 6 ↑	
<b>Order No. supplement for rated control supply voltage <i>U<sub>s</sub></i></b>											Spring-loaded terminals Screw-type terminals AC 115 V AC 230 V 3 4	

# Configuration Notes

## Selection aid for soft starters

Application		3RW30	3RW40	3RW44
Normal starting (CLASS 10)	Pump	●	●	●
	Pump with special pump stop (against water hammer)			●
	Heat pump	●	●	●
	Hydraulic pump	○	●	●
	Press	○	●	●
	Belt conveyor	○	●	●
	Roller conveyor	○	●	●
	Screw conveyor	○	●	●
	Escalator		●	●
	Piston compressor		●	●
	Screw compressor		●	●
	Small fan		●	●
	Centrifugal blower		●	●
	Bow thruster		●	●
Heavy-duty starting (Class 20)	Agitator		○	●
	Extruder		○	●
	Turning machine		○	●
	Milling machine		○	●
Ultra-heavy-duty starting (Class 30)	Large fan			●
	Circular saw/band saw			●
	Centrifuge			●
	Mill			●
	Crusher			●
<b>Soft starter functions</b>				
	Soft start function	●	●	●
	Soft stop function		●	●
	Integrated intrinsic device protection		●	●
	Integrated electronic motor overload protection		●	●
	Settable current limiting		●	●
	Special pump stop function			●
	Brakes in ramp-down			●
	Settable breakaway torque			●
	Communication via PROFIBUS (optional)			●
	External operation and indication display (optional)			●
	Soft Starter ES parameterization software			●
	Special functions, e.g. measured values, display language, etc.			●

- recommended soft starter
- possible soft starter

## Boundary conditions

### CLASS 10 (normal starting):

3RW30:

Maximum start-up time 3 sec., with 300 % starting current, 20 starts/hour

3RW40/44:

Maximum start-up time 10 sec., current limiting 300 %, 5 starts/hour

### CLASS 20 (heavy-duty starting):

3RW402., 3RW403., 3RW404.:

Maximum start-up time 20 sec., current limiting set to 300 %, maximum 5 starts/hour

3RW405., 3RW407., 3RW44:

Maximum start-up time 40 sec., current limiting set to 350 %, maximum 1 start/hour

### CLASS 30 (ultra-heavy-duty starting):

Maximum start-up time 60 sec., current limiting set to 350 %, maximum 1 start/hour

### General boundary conditions:

ON period 30 %

Stand-alone assembly

Installation altitude: maximum 1000 m/3280 ft

Ambient temperature:

kW: 40 °C / 104 °F

hp: 50 °C / 122 °F

The stated motor ratings are only approximate values. The soft starter's dimensioning should always exceed the motor current (rated operating current). With deviating conditions, a larger device may have to be selected.

Motor rating data are based on DIN 42973 (kW) and NEC 96/UL508 (hp).

For further details and information (e.g. regarding accessories and spare parts), please refer to the catalog IC 10 "Industrial Controls" or to the catalog's current online edition on the Internet at: [www.siemens.com/industrial-controls/catalogs](http://www.siemens.com/industrial-controls/catalogs)

General and further information on SIRIUS soft starters is available on the Internet at: [www.siemens.com/sirius-soft-starter](http://www.siemens.com/sirius-soft-starter)

The selection tools for SIRIUS soft starters provide a reference value for finding the suitable starter size for your application or for your star-delta start-up to be replaced. We recommend our Siemens Technical Assistance for dimensioning soft starters for motors with high starting current conditions (typically  $I/I_e \geq 8$ ).

**Technical Assistance: +49 911 895 5900**

E-mail: [technical-assistance@siemens.com](mailto:technical-assistance@siemens.com)

## Recommended parameter settings

Application	U <sub>Start</sub> %	t <sub>Start</sub> S	I <sub>limi</sub> 3RW40/44	U <sub>Kick</sub> 3RW44	t <sub>Stop</sub>	CLASS 3RW40/44
Pump	40	10	3–4xIM	---	10	10
Heat pump	40	10	3–4xIM	---	10	10
Hydraulic pump	40	10	3–4xIM	---	0	10
Press	40	10	OFF (e.g. 5xIM)	---	0	10
Belt conveyor	70	10	OFF (e.g. 5xIM)	---	5	10
Roller conveyor	60	10	OFF (e.g. 5xIM)	---	5	10
Screw conveyor	50	10	OFF (e.g. 5xIM)	---	5	10
Escalator	60	10	4xIM	---	0	10
Piston compressor	40	10	4xIM	---	0	10
Screw compressor	50	10	4xIM	---	10	10
Small fan <sup>1)</sup>	40	10	4xIM	---	10	10
Centrifugal blower	40	10	4xIM	---	10	10
Bow thruster	40	10	4xIM	---	10	10
Agitator	40	30	3–4xIM	---	10	20
Extruder	70	10	OFF (e.g. 5xIM)	---	10	20
Turning machine	40	30	3–4xIM	---	10	20
Milling machine	40	30	3–4xIM	---	10	20
Large fan <sup>2)</sup>	40	60	3–4xIM	---	10	30
Circular saw/band saw	40	60	3–4xIM	---	10	30
Centrifuge	40	60	3–4xIM	---	10	30
Mill	40	60	3–4xIM	80 % 300 ms	10	30
Crusher	40	60	3–4xIM	80 % 300 ms	10	30

<sup>1)</sup> Mass moment of inertia of the fan < 10x mass moment of inertia of the motor

<sup>2)</sup> Mass moment of inertia of the fan ≥ 10x mass moment of inertia of the motor

Siemens AG  
Industry Sector  
Industry Automation  
Control Components and  
Systems Engineering  
P.O. Box 23 55  
90713 FÜRTH  
GERMANY

Subject to change without prior notice 08/13  
Order No.: E20001-A1040-P302-V5-7600  
Dispo 27601  
WÜ/46842 MI.CE.SG.SRXX.52.3.05 WS 08133.  
Printed in Germany  
© Siemens AG 2013

The information provided in this brochure contains merely general descriptions or characteristics of performance which in case of actual use do not always apply as described or which may change as a result of further development of the products. An obligation to provide the respective characteristics shall only exist if expressly agreed in the terms of contract.

All product designations may be trademarks or product names of Siemens AG or supplier companies whose use by third parties for their own purposes could violate the rights of the owners.