

 **DENFORD**

Product Catalogue

CAD/CAM Solutions & Projects for Education

NEW



UP BOX - Compact 3D Desktop Printer

- Fully Automatic Platform Calibration
- Large Build Volume: 255 x 205 x 205mm
 - Powerful, Easy-to-use Software
 - High Quality, High Definition Models

JANUARY 2015 EDITION

Denford are the proud sponsors of:



INNOVATIVE EDUCATIONAL PROJECTS

Welcome Dear Reader,

to the latest edition of the Denford Product Catalogue - CAD/CAM Solutions & Projects for Education

At a time of rapid technological advances schools should consider new approaches to teaching and learning. Pupils need to learn about new materials and technologies and to investigate, practically, how and why products work. This edition of our catalogue is crammed full of new and innovative products which support exciting and creative teaching of design and technology in schools. This includes imaginative use of our educational projects such as the F1 in Schools Technology Challenge – the world’s most exciting STEM-based educational project.

To further support the delivery of STEM-related qualifications, Denford is currently working as an “industrial partner” with a significant number of University Technical Colleges (UTC’s), which teach engineering, technical and scientific subjects in a completely new way and are educating our future engineers, scientists, technicians and inventors. F1 in Schools (and the Land Rover 4x4 in Schools Challenge) are used by UTC’s for delivery of the curriculum and also to provide students with real-life employer projects that stretch their technical skills and creative thinking. This approach to teaching incorporates the use of traditional CAD/CAM and CNC products, as well as new and innovative technologies such as compact desktop 3D printers – ensuring that students are learning advanced technical skills which will be crucial for our country’s future economic success.

Rapid prototyping continues to be a major focus and this edition of our Catalogue features a complete range of rapid prototyping products: the UP mini offers unbelievable performance at a budget price, and the UP Plus 2 and the UP BOX compact 3D printers both feature automatic calibration systems as standard – providing easy to use solutions to all your 3D printing requirements!

Please feel free to contact me directly at info@denford.co.uk if you would like any additional information on our products, services, educational projects and our unique approach to the delivery of STEM-based educational subjects and qualifications.

We hope you enjoy our new Catalogue and thank you for your continued support.

Yours sincerely

Simon Moorhouse
Managing Director



WHAT TO LOOK OUT FOR...



**Router 2600 ATC
Router 6600 ATC**

Pages 16 - 17

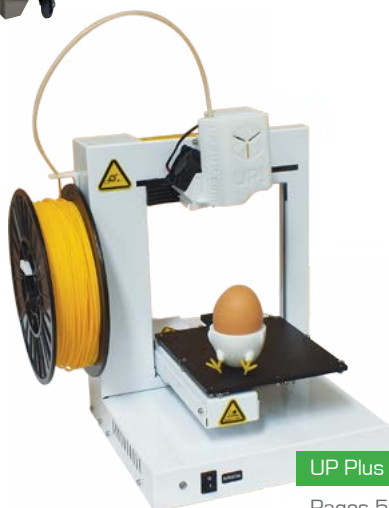

UP Plus 2 3D Printer

Pages 54 - 55



UP BOX 3D Printer

Pages 56 - 57

Contents

PROJECTS

Denford - Proud Founders & Sponsors of:

F1 in Schools Technology Challenge	4 - 5
Jaguar Primary School Challenge	6
Land Rover 4x4 in Schools Technology Challenge	7

MACHINES

PCB Engraver	8 - 9
MRC 40	10 - 11
Compact 1000 PRO	12 - 13
Router 2600 / Router 2600 PRO	14 - 15
Router 2600 ATC & Router 6600 ATC	16 - 17
Router 6600 / Router 6600 PRO	18 - 19
Vertical Router	20 - 21

Routing Accessories:

Floating Head, 5 Station ATC	22
Dust Pro 100, Dust Pro 50.	22
F1 Car Manufacturing Fixture, Clamping Kit,	23
Large Format Vacuum Bed, Vac Pads.	23
EasySCAN 3D Scanner	24
4th Axis Rotary Fixture	25

VMC 1300 / VMC 1300 PRO	26 - 27
Turn 270 PRO	28 - 29
Turn 370 PRO	30 - 31
Micromill / Microturn	32 - 33
Universal Machine Benches	34 - 35
Refurbishment and Re-Warranty Package	36 - 37

SOFTWARE

LaserCAM 2D Design	38 - 39
QuickCAM 2D Design	40 - 41
QuickCAM Pro	42 - 43
VR CNC Milling 5	44 - 45
QuickTURN 2D Design	46 - 47
VR CNC Turning	48 - 49
Virtual Wind Tunnel	50 - 51

RAPID PROTOTYPING

UP mini 3D Printer	52 - 53
UP Plus 2 3D Printer	54 - 55
UP BOX 3D Printer	56 - 57
Tiertime Inspire 3D Printers	58 - 59

LASERS

VLS Series Lasers	60 - 61
Large Format VLS Series Lasers	62 - 63

PACKAGE SOLUTIONS

F1 in Schools Package	64 - 65
3D Scanning and Manufacturing Package	66 - 67
NextEngine - 3D HD Scanning	68 - 69

RESOURCE

F1 in Schools Curriculum Resources	70 - 71
------------------------------------	---------

CONSUMABLES

F1 Equipment & Consumables	72 - 77
Land Rover 4x4 Starter Kit & Track Elements	78 - 79
Denford Consumables	80 - 83

PROUD FOUNDERS & SPONSORS OF...



The F1 in Schools Technology Challenge

F1 in Schools is a multi-disciplinary challenge in which teams of students aged 9 to 19 deploy CAD/CAM software to collaborate, design, analyse, manufacture, test, and then race miniature gas powered balsa wood F1 cars. F1 in Schools is the world's largest STEM-based (Science, Technology, Engineering and Maths) educational project.

Students taking part in the challenge are inspired to learn about physics, aerodynamics, design, manufacture, branding, graphics, sponsorship, marketing, leadership/teamwork, media skills and financial strategy, and apply them in a practical, imaginative, competitive and exciting way.

The challenge is supported with the F1 in Schools Curriculum Resource, a set of cross-curricular materials to help you run a project based on the F1 in Schools competition. Designed for pupils aged between 9 and 19, it includes over 60 fully-resourced session plans - everything you need for running the project in your school.

With F1 in Schools now operating globally in over 40 countries and currently with over 20 million students aware of the challenge, F1 in Schools provides a real opportunity for a learning experience of a lifetime and the chance to become a World Champion!



The 10th F1 in Schools World Finals took place in Abu Dhabi in November 2014 and linked to the 2014 Formula 1 Etihad Airways Abu Dhabi Grand Prix. With 38 teams competing for the Bernie Ecclestone World Champions Trophy, Colossus F1 from Robert May's School, Odiham, Hampshire, England, were crowned the F1 in Schools 2014 World Champions.

In addition to F1 in Schools, Denford Limited are also the proud Founders and Sponsors of the 'Land Rover 4x4 in Schools Technology Challenge' in partnership with Land Rover, The IET, WNT, IRob and Harper Adams University and is also supported by Industrial Cadets, Crest Awards and Arkwright Scholarship Trust; and the 'Jaguar Primary School Challenge' in partnership with Jaguar Cars.

For further information please visit the following sites or follow us on:

f1inschools.com
4x4inschools.com
f1inschools.co.uk/primary

 Like us
@F1inSchoolsLtdUK

 Join us
F1 in Schools Alumni Group

 follow us
@F1inSchoolsHQ

 Watch us
on F1 in Schools HQ

Andrew Denford
Founder and Chairman, F1 in Schools Ltd

INNOVATIVE EDUCATIONAL PROJECTS



The F1 in Schools Technology Challenge encourages students to explore a variety of engineering and manufacturing processes by using CAD/CAM and CNC technology to produce their own model F1® Car of the Future.

As founding partners of the F1 in Schools Technology Challenge, Denford supply a wide range of equipment and training to get you to the starting line. In addition, Denford also support the Land Rover 4x4 in Schools Technology Challenge and the Jaguar Primary School Challenge.



Business Plan

Prepare a **business plan**, develop a budget and raise sponsorship. Teams are encouraged to collaborate with industry and create business links.

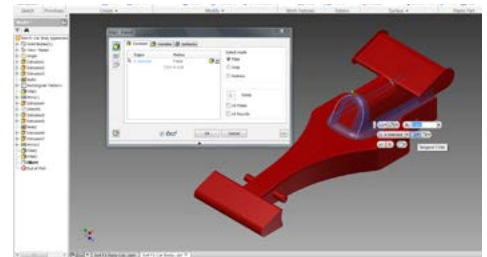

Design

Using 3D CAD (Computer Aided Design) software, **design** an F1® car of the future to the specifications set by the International Rules Committee just like in Formula 1®.



Analyse

Aerodynamics are **analysed** for drag coefficient in a virtual wind tunnel using Computational Fluid Dynamics Software (CFD).

Make

Using 3D CAM (Computer Aided Manufacture) software, the team evaluates the most efficient machining strategy to **make** the car.



Test

Aerodynamics are **tested** in wind and smoke tunnels.

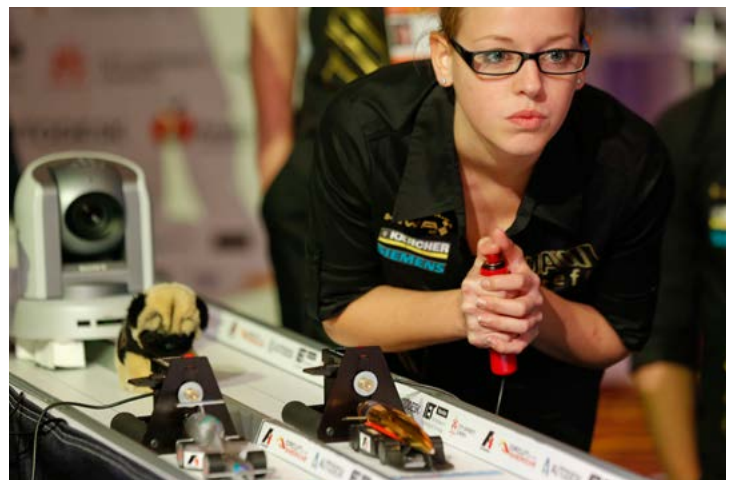

RACE !

Time to test what your team has worked so hard together to achieve: a **winning car**.

F1 IN SCHOOLS CURRICULUM RESOURCE
See Pages 70 - 71

f1inschools.com

PROUD FOUNDERS & SPONSORS OF...



F1 in Schools - Jaguar Primary School Challenge (F1-JPSC) engages with primary schools students and teachers across the UK in the same way as the Secondary School Challenge. The challenge is open to students aged 5-11 years old and involves designing and manufacturing the fastest car possible, emulating the design and engineering processes employed by real engineering companies, such as Jaguar Cars. Students are challenged to form a team of 4 pupils and design a race car out of 160g/m² card, complete with wheels, body and even a mini driver. They will design and manufacture a body shell to fit a standard chassis using template software before printing/cutting their designs on to card and then making their car ready to race.

The Jaguar Primary School Challenge is sponsored and supported by Jaguar Cars, who have been a supporter of F1 in Schools since its launch in 2000. Jaguar understand the need to encourage and motivate young people to develop key skills needed for companies such as Jaguar to be successful in producing award-winning vehicles. The Jaguar Primary School Challenge has its own rules and regulations but the judging process is the same as the secondary school challenge.



F1-JPSC offers primary school pupils the opportunity to:

- Take part in a fun hands-on STEM (Science, Technology, Engineering & Maths) activity
- Tackle real life problem solving and learning
- Develop design, manufacturing, team work, communication & business skills
- Work with Jaguar Land Rover Graduates (who mentor the teams and the students)
- Win a VIP experience at Jaguar Land Rover plus other awards & prizes for their school
- Take part in a UK Nationwide challenge

In addition, teachers gain professional accreditation through the College of Teachers

The Rules and Regulations are available to download from the website:

f1inschools.co.uk/primary

INNOVATIVE EDUCATIONAL PROJECTS

Land Rover 4x4 in Schools Challenge

Teams of 3 to 6 young people working together are challenged to design and build a radio controlled 4-wheel-drive (4x4) vehicle - to set specifications - which can successfully negotiate a series of obstacles and tasks. The vehicles will be tested on a specially designed test track, emulating real life and what a full scale 4x4 vehicle can do. Teams entering the challenge will spend a number of weeks designing, researching, building and project managing their 4x4 vehicle to enter it into a regional heat, to compete against other schools from their area. Regional winners will be selected through a judging process (please see the rules and regulations document) to go through to the National Final where they will compete again, but this time, against the other regional winners to challenge to become the Land Rover 4x4 in Schools Technology Challenge UK National Champions.



This National Challenge offers an exciting opportunity to encourage the development of our engineers of tomorrow, to engage young people in the complexities and challenges of design engineering, and to demonstrate the rewards of choosing engineering as a career.

Sponsored by:
Denford Ltd, Land Rover, The IET, WNT, IRob and Harper Adams University and supported by Industrial Cadets, Crest Awards and Arkwright Scholarship Trust.

4x4inschools.com



LAND ROVER 4x4 STARTER KIT & TRACK ELEMENTS

See Pages 78 - 79



DENFORD

PCB Engraver

3 AXIS CNC PCB AND ENGRAVING MACHINE

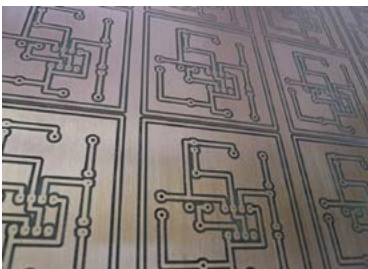

The PCB Engraver is ideal for manufacture of PCB boards.

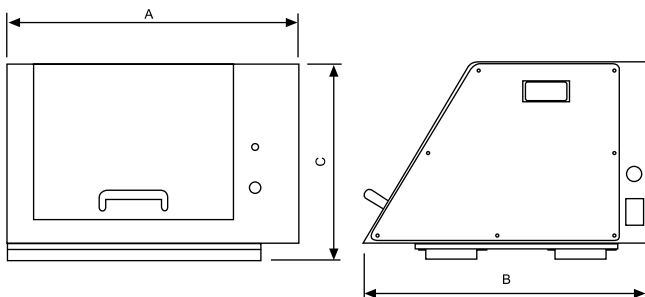

Machine Dimensions.

A 3 axis CNC PCB and Engraving Machine with totally-enclosed guarding, suitable for all levels of education and training. The PCB Engraver is supplied with operating software incorporating Gerber and DXF import facilities.

The PCB Engraver is ideal for cutting and engraving a range of resistant materials, including copper board, plastic and acrylic.

Denford's PCB Engraving Machine features the latest 'Floating Head' technology. The floating head allows manufacture of PCB's, and engraving of uneven surfaces. The PCB Engraver is also ideal for batch manufacture of PCB boards.

PCB Engraver

Denford's PCB Engraver is ideal for schools wishing to move away from traditional methods of chemical etching of PCB boards.

THE PCB ENGRAVER COMES AS STANDARD WITH:

- Powerful operating software that is simple to use and allows multiple designs to be made at once.
- High speed spindle motor and floating head technology.
- Basic tools and depth-setting device.
- Outlet for dust extraction.
- Sacrificial Table.
- Installation and Instruction Manuals.
- USB Connection.

The PCB Engraver software will import Gerber files or CNC G-Code files. Third party PCB software is required to create Gerber files, and QuickCAM 2D Design software would be an ideal addition to create CNC G-Code.

Please Note:

- Dust extraction is essential to allow the machine to function. The DP-50 is ideal - see page 22.
- The machine spindle has a 20 minute 50% duty cycle, so use of additional spindle motors for tool changing will increase productivity.

Tool changes are a simple process and allow drilling of larger holes, and the adjustable spindle speed and feedrate make the PCB Engraver ideal for cutting or engraving a range of resistant materials such as plastic, acrylic and copper board. The floating head combined with powerful new software, makes manufacture a quick and easy process.

QUALITY, PRECISION, MAINTENANCE FREE ROUTING

Denford supply CNC Routers with precision anti-backlash nuts/leadscrews, as they provide a highly reliable, accurate and almost maintenance-free solution and are perfect for use in a dusty environment. Anti-backlash nuts and lead screws provide a number of clear technical advantages:

Zero maintenance / No lubrication required / Lower particulate generation / Longer life with non-catastrophic failure / Quieter operation (no re-circulating ball noise) / High helix / Fast leads / Zero-backlash with very light pre-load / low drag

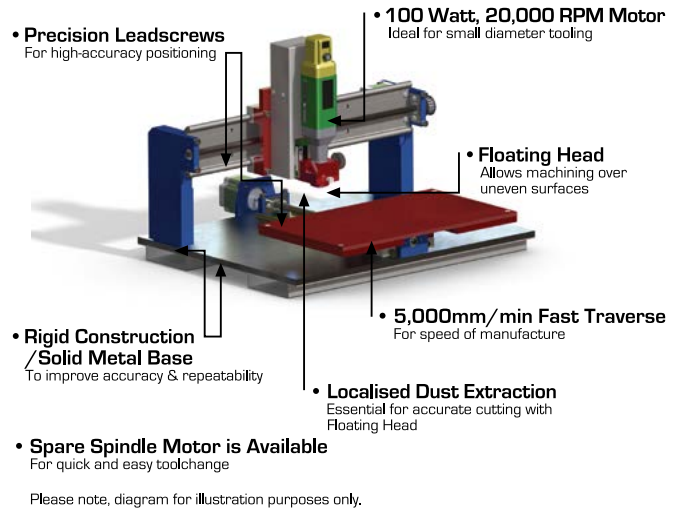

MECHANICAL DETAILS	PCB ENGRAVER
Machine Length (A)	570mm
Machine Depth (B)	585mm
Machine Height (C)	385mm
Machine Weight	43kg
Table Size	360 x 210mm
Travel X Axis	330mm
Travel Y Axis	210mm
Travel Z Axis	40mm
Float Z Axis	5mm
Beam Clearance	50mm
Max. Spindle Speed	20,000rpm
Spindle Speed Control	Manual
Max. Feed Rate	5000mm/min
Max. Contouring Feed Rate	1000mm/min
Mains Supply Requirements* [* Alternative supplies available on request]	Single Phase
Spindle Motor	100 Watts
Axes Motors	Stepper
Volts	230 Volts
Current	5 Amps
Hz	50/60 Hz

DENFORD

MRC 40

VERSATILE, AFFORDABLE ROUTER, MILLER & ENGRAVER



**QUALITY, PRECISION,
MAINTENANCE FREE
ROUTING**

For full details - See page 9

Shown with optional universal bench and computer support extension. (PC not included)

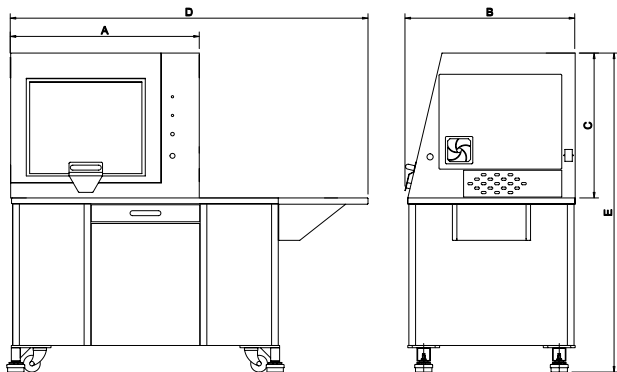

Machine Dimensions.

Denford's high-spec / low-cost solution for all your routing, milling and engraving needs. The MRC 40 has a powerful 500W spindle motor and offers high speed manufacture linked with a large working envelope. This versatile machine handles small engraving jobs, and the large working envelope and Z axis capability (110mm) is perfect for the manufacture of large 3D designs. Set-up and tool changes are a simple process, and the MRC 40 has a host of optional extras for specialist applications.



Ideal for use in conjunction with



IN SCHOOLS

MRC 40

THE MRC 40 COMES AS STANDARD WITH:

- VR CNC Milling Operating Software (PC not included)
- Powerful 500W High Speed Spindle
- Sacrificial Table
- Outlet for Dust Extraction System
- 8mm and 1/4" Collets
- Installation and Instruction Manuals
- USB Connection

OPTIONAL EQUIPMENT INCLUDES:

The MRC 40 is available with everything you need to get you up and running immediately. In addition, there is a full range of optional items.

- Resources Pack (including a variety of 2D, 3D & engraving tooling and drill bits, foam & acrylic billets, double-sided tape)
- QuickCAM 2D Design Software
- QuickCAM PRO Software
- Aluminium T-Slot Table and Clamping Kit (factory fitted)
- F1 in Schools Car Manufacturing Fixture (only available when T-Slot Table fitted)
- Spare Spindle Motor Assembly for quick tool change
- Vacuum Pads x 2 with Integral Pump
- Floating Head for PCB Manufacture
- Universal Machine Bench & Computer Support Arm

RECOMMENDED SOFTWARE PROGRAMS

Please refer to Compact 1000 PRO - see page 13.

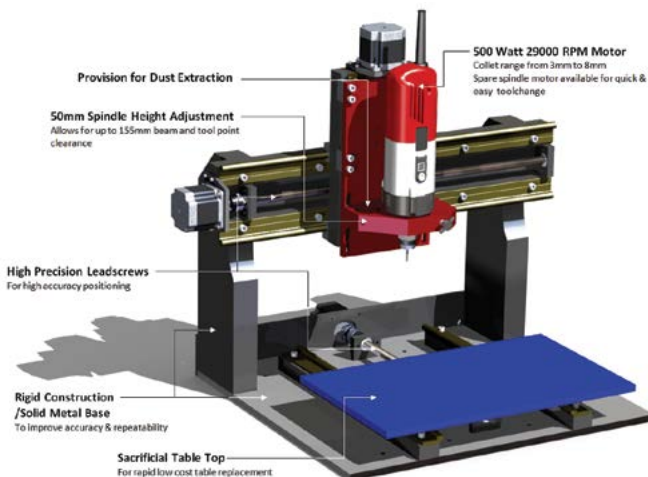

Please note, diagram for illustration purposes only.

SYSTEM REQUIREMENTS

Please refer to page 29.

SEAMLESS IMPORT OF TECHSOFT 2D DESIGN FILES:

The import routine with Denford's VR CNC Milling V5 operating software works with Techsoft 2D Design Tools Versions 1 & 2 and also with ALL major CAD packages. It is far more advanced than the Techsoft post-processor, supplied with Techsoft Version 1 and is far simpler to use.

ALL Denford machines operating with VR CNC Milling V5 are able to import designs drawn in Techsoft Versions 1 & 2, saved in DXF format, **without any additional software or post processor being required.**

VR Milling V5 has the facility to import DXF, DWG and Gerber files, which then allows multiple toolpaths to be created. The toolpaths are generated using the vector data imported and not colours, fill or line width.

MECHANICAL DETAILS	MRC 40
Machine Length (A)	875mm
Machine Depth (B)	765mm
Machine Height (C)	675mm
Length with Optional Base (D)	1678mm
Height with Optional Base (E)	1440mm
Machine Weight	113kg
Machine Weight with Opt. Base	227kg
Table Size	400 x 240mm
Travel X Axis	400mm
Travel Y Axis	240mm
Travel Z Axis	110mm
Beam Clearance (max work height)	155mm
Max. Spindle Speed	29000rpm
Feed Override	0 - 150%
Max. Feed Rate	5000mm/min
Max. 3D Profiling	4500mm/min
Mains Supply Requirements* [* Alternative supplies available on request]	Single Phase
Axes Motors	Stepper
Spindle Motor	500 Watts
Volts	230VAC
Amps	5 Amps
Hz	50 Hz
Electric Connection	13 A Socket

DENFORD

Compact 1000 PRO

COMPACT METAL CUTTING 3 AXIS CNC ROUTER



**QUALITY, PRECISION,
MAINTENANCE FREE
ROUTING**

For full details - See page 9

Shown with optional universal bench and
computer support extension.
(PC not included)

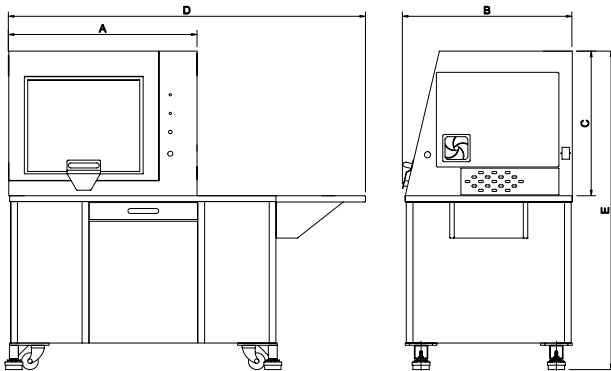

Machine Dimensions.

A compact 3 axis CNC Router with totally enclosed interlocking guard, suitable for all levels of education and training. The Compact 1000 Pro is ideal for cutting a range of resistant materials such as hard and soft wood, plastic, modelling foam, acrylic and prototyping materials, as well as non-ferrous metals.

CE
APPROVED

Ideal for use in conjunction with

IN SCHOOLS

Compact 1000 PRO

THE COMPACT 1000 PRO COMES AS STANDARD WITH:

- VR CNC Milling Operating Software (PC not included).
- QuickCAM 2D Design software (1 seat)
- Aluminium T Slot Table.
- Outlet for Dust Extraction System.
- Workholding Clamps.
- Installation and Instruction Manuals.
- USB Connection.

OPTIONAL EQUIPMENT INCLUDES:

Vacuum Pads, F1 in Schools Car Manufacturing Fixture, 4th Axis Programmable Rotary Fixture, 3D Scanning Attachment, Universal Machine Bench and Dust Extraction Unit.

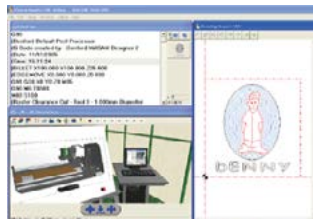

SYSTEM REQUIREMENTS

Please refer to page 29.

RECOMMENDED SOFTWARE PROGRAMS

All software necessary to control the Compact 1000 Pro is included. Also included is a seat of QuickCAM 2D Design - an easy to use 2D CAD package.

• 2D Designs: The VR Milling software can import DXF, DWG, EPS and Gerber files in addition to G & M code programs and as such will link with programs such as Techsoft 2D Design and CorelDraw.

• 3D Designs: To enable import of STL files from 3D design packages such as Autodesk Inventor, SolidWorks, Pro/DESKTOP & ArtCAM, QuickCAM Pro software is required (see pages 40 - 41).

MECHANICAL DETAILS	COMPACT 1000 PRO
Machine Length (A)	875mm
Machine Depth (B)	765mm
Machine Height (C)	675mm
Length with Optional Base (D)	1678mm
Height with Optional Base (E)	1440mm
Machine Weight	116kg
Machine Weight with Opt. Base	230kg
Table Size	400 x 240mm
Travel X Axis	400mm
Travel Y Axis	240mm
Travel Z Axis	110mm
Beam Clearance	140mm
Max. Spindle Speed	24000rpm
Non-Ferrous Metal Cutting	Yes
Spindle Speed Control	Yes
Spindle Speed Override	Yes
Max. Feed Rate	5000mm/min
Max. 3D Profiling	4500mm/min
Mains Supply Requirements * [* Alternative supplies available on request]	Single Phase
Spindle Motor	1.0kW
Axes Motors	Stepper
Volts	230VAC
Amps	8 Amps
Hz	50 Hz
Electric Connection	13 A Socket

DENFORD

Router 2600/2600 PRO

3 AXIS CNC ROUTER



**NOW AVAILABLE:
ROUTER 2600 ATC
SEE PAGES 16-17**

**QUALITY, PRECISION,
MAINTENANCE FREE
ROUTING**

For full details - See page 9

Shown with optional universal bench,
optional computer support extension and
optional integrated Dust Pro 100
(PC not included)

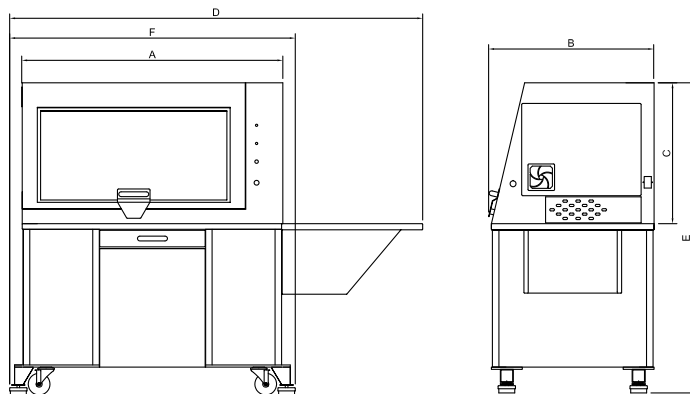

Machine Dimensions.

A 3 axis CNC Router with totally enclosed interlocking guard, suitable for all levels of education and training. With its large capacity the Router 2600 is ideal for cutting a range of resistant materials such as hard and soft wood, plastic, modelling foam, acrylic and prototyping material. In addition, the Router 2600 Pro can cut non-ferrous metals.

CE
APPROVED

Ideal for use in conjunction with

IN SCHOOLS

Router 2600/2600 PRO

THE ROUTER 2600/2600 PRO COME AS STANDARD WITH:

- VR CNC Milling Operating Software (PC not included).
- QuickCAM 2D Design software (1 seat)
- Aluminium T Slot Table.
- Outlet for Dust Extraction System.
- Workholding Clamps.
- Installation and Instruction Manuals.
- USB Connection.

OPTIONAL EQUIPMENT INCLUDES:

Vacuum Bed, Vacuum Pads, F1 in Schools Car Manufacturing Fixture, 4th Axis Programmable Rotary Fixture, 3D Scanning Attachment, Dust Extraction Unit and Universal Machine Bench.

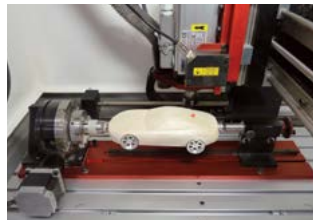

SYSTEM REQUIREMENTS

Please refer to page 29.

RECOMMENDED SOFTWARE PROGRAMS

All software necessary to control the Router 2600/ Router 2600 Pro is included. Also included is a seat of QuickCAM 2D Design - an easy to use 2D CAD package.

• 2D Designs: The VR Milling software can import DXF, DWG, EPS and Gerber files in addition to G & M code programs and as such will link with programs such as Techsoft 2D Design and CorelDraw.

• 3D Designs: To enable import of STL files from 3D design packages such as Autodesk Inventor, SolidWorks, Pro/DESKTOP & ArtCAM, QuickCAM Pro software is required (see pages 40 - 41).

MECHANICAL DETAILS	ROUTER 2600	ROUTER 2600 PRO
Machine Length (A)	1200mm	
Machine Depth (B)	765mm	
Machine Height (C)	675mm	
Length with Optional PC Arm (D)	1910mm	
Height with Optional Base (E)	1440mm	
Length with Optional Base (F)	1325mm	
Machine Weight	150kg	
Machine Weight with Opt. Base	255kg	
Table Size	700 x 430mm	
Travel X Axis	600mm	
Travel Y Axis	400mm	
Travel Z Axis	110mm	
Beam Clearance	150mm	
Max. Spindle Speed	29000rpm	24000rpm
Non-Ferrous Metal Cutting	No	Yes
Spindle Speed Control	No	Yes
Spindle Speed Override	No	Yes
Max. Feed Rate	5000mm/min	
Max. 3D Profiling	4500mm/min	
Mains Supply Requirements* [* Alternative supplies available on request]	Single Phase	
Spindle Motor	1.0kW	
Axes Motors	Stepper	
Volts	230VAC	
Amps	8 Amps	
Hz	50 Hz	
Electric Connection	13 A Socket	

DENFORD

Router 2600 ATC & Router 6600 ATC

3 AXIS CNC ROUTERS WITH 5 STATION ATC

NEW



5 Station Automatic Tool Changer

**QUALITY, PRECISION,
MAINTENANCE FREE
ROUTING**

For full details - See page 9

Router 2600 ATC shown with optional universal bench, optional computer support extension and optional integrated Dust Pro 100 (PC not included)

For Router 2600 ATC Machine Dimensional Drawings

See page 14.

For Router 6600 ATC Machine Dimensional Drawings

See page 18.

These 3 axis CNC Routers with totally enclosed interlocking guard and complete with 5 Station Automatic Tool Changer are suitable for all levels of education and are ideal for cutting a range of resistant materials such as hard and soft wood, plastic, modelling foam, acrylic, prototyping material and non-ferrous metals.

Additionally, the Router 6600 ATC is a high speed machine, complete with built-in machine bench, offering large machining capacity (table size 1080 x 640mm) at an exceptional price.



Ideal for use in conjunction with



IN SCHOOLS

Router 2600 ATC & Router 6600 ATC

THE ROUTER 2600 ATC & ROUTER 6600 ATC COME AS STANDARD WITH:

- VR CNC Milling Operating Software (PC not included).
- QuickCAM 2D Design software (1 seat)
- 5 Station Automatic Tool Changer (5 SK11 Toolholders and 8 Collets) Requires compressed air, 8 bar.
- Aluminium T Slot Table.
- Outlet for Dust Extraction System.
- Workholding Clamps.
- Installation and Instruction Manuals.
- USB Connection.

In addition the Router 6600 ATC comes complete with Universal Machine Bench.

OPTIONAL EQUIPMENT INCLUDES:

Vacuum Bed, Vacuum Pads, F1 in Schools Car Manufacturing Fixture, 4th Axis Programmable Rotary Fixture, 3D Scanning Attachment, Dust Extraction Unit and Universal Machine Bench (Router 2600 ATC).



SYSTEM REQUIREMENTS

Please refer to page 29.

RECOMMENDED SOFTWARE PROGRAMS

All software necessary to control the Router 2600 ATC & Router 6600 ATC is included. Also included is a seat of QuickCAM 2D Design - an easy to use 2D CAD package.

• 2D Designs: The VR Milling software can import DXF, DWG, EPS and Gerber files in addition to G & M code programs and as such will link with programs such as Techsoft 2D Design and CorelDraw.

• 3D Designs: To enable import of STL files from 3D design packages such as Autodesk Inventor, SolidWorks, Pro/DESKTOP & ArtCAM, QuickCAM Pro software is required (see pages 40 - 41).

MECHANICAL DETAILS	ROUTER 2600 ATC	ROUTER 6600 ATC
Machine Length (A)	1200mm	1825mm
Machine Depth (B)	765mm	985mm
Machine Height (C)	675mm	1540mm
Length with Optional PC Arm (D)	1910mm	2410mm
Height with Optional Base (E)	1440mm	-
Height with Door Open (E)	-	2110mm
Length with Optional Base (F)	1325mm	-
Machine Weight	150kg	430kg
Machine Weight with Opt. Base	255kg	-
Table Size	700 x 430mm	1080x 640mm
Travel X Axis	600mm	1000mm
Travel Y Axis	400mm	600mm
Travel Z Axis	110mm	110mm
Beam Clearance	150mm	148mm
Max. Spindle Speed	24000rpm	
Non-Ferrous Metal Cutting	Yes	
Spindle Speed Control	Yes	
Spindle Speed Override	Yes	
Max. Feed Rate	5000mm/min	
Max. 3D Profiling	4500mm/min	
Mains Supply Requirements* [* Alternative supplies available on request]	Single Phase	
Spindle Motor	0.9kW	
Axes Motors	Stepper	
Volts	230VAC	
Amps	8 Amps	
Hz	50 Hz	
Electric Connection	13 A Socket	

DENFORD

Router 6600/6600 PRO

LARGE FORMAT, HIGH SPEED FLOOR-STANDING ROUTER

**NOW AVAILABLE:
ROUTER 6600 ATC
SEE PAGES 16-17**



**QUALITY, PRECISION,
MAINTENANCE FREE
ROUTING**

For full details - See page 9

Shown with optional computer support extension
and optional integrated Dust Pro 100
(PC not included)

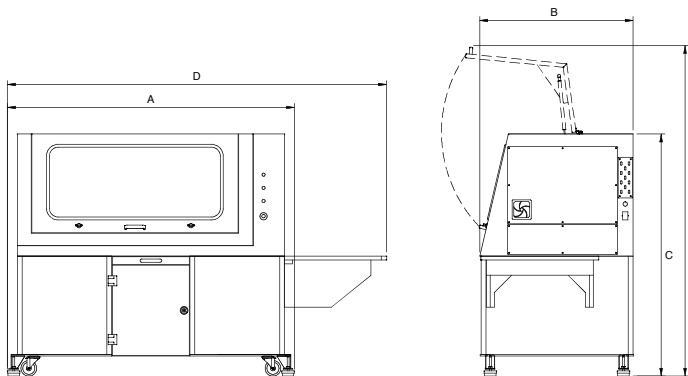

Machine Dimensions.

A large format, high speed Router, complete with built-in machine bench, offering large machining capacity [table size 1080 x 640mm] at an exceptional price. The Router 6600 / 6600 Pro is specifically designed for education and training and is ideal for cutting a range of resistant materials such as hard and soft wood, plastic, modelling foam, acrylic and prototyping material. In addition, the Router 6600 Pro can cut non-ferrous metals.

CE
APPROVED

Ideal for use in conjunction with

IN SCHOOLS

Router 6600/6600 PRO

THE ROUTER 6600/6600 PRO COME AS STANDARD WITH:

- VR CNC Milling Operating Software (PC not included).
- QuickCAM 2D Design software (1 seat)
- Universal Machine Bench.
- Aluminium T Slot Table.
- Outlet for Dust Extraction System.
- Workholding Clamps.
- Installation and Instruction Manuals.
- USB Connection.

OPTIONAL EQUIPMENT INCLUDES:

Large Format Vacuum Bed, Vacuum Pads, F1 in Schools Car Manufacturing Fixture, 4th Axis Programmable Rotary Fixture, 3D Scanning Attachment, Dust Extraction Unit, Computer Support Extension.

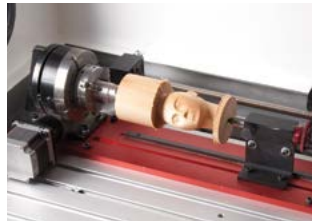

SYSTEM REQUIREMENTS

Please refer to page 29.

RECOMMENDED SOFTWARE PROGRAMS

All software necessary to control the Router 6600/ Router 6600 Pro is included. Also included is a seat of QuickCAM 2D Design - an easy to use 2D CAD package.

- 2D Designs: The VR Milling software can import DXF, DWG, EPS and Gerber files in addition to G & M code programs and as such will link with programs such as Techsoft 2D Design and CorelDraw.
- 3D Designs: To enable import of STL files from 3D design packages such as Autodesk Inventor, SolidWorks, Pro/DESKTOP & ArtCAM, QuickCAM Pro software is required (see pages 40 - 41).

MECHANICAL DETAILS	ROUTER 6600	ROUTER 6600 PRO
Machine Length (A)	1825mm	
Machine Depth (B)	985mm	
Machine Height (C)	1540mm	
Length with Optional PC Arm (D)	2410mm	
Height with Door Open (E)	2110mm	
Machine Weight	430kg	
Table Size	1080 x 640mm	
Travel X Axis	1000mm	
Travel Y Axis	600mm	
Travel Z Axis	110mm	
Beam Clearance	148mm	
Max. Spindle Speed	29000 RPM	24000 RPM
Non-Ferrous Metal Cutting	No	Yes
Spindle Speed Control	No	Yes
Spindle Speed Override	No	Yes
Max. Feed Rate	5000mm/min	
Max. 3D Profiling	4500mm/min	
Mains Supply Requirements* [* Alternative supplies available on request]	Single Phase	
Spindle Motor	1.0kW	
Axes Motors	Stepper	
Volts	230VAC	
Amps	8 Amps	
Hz	50 Hz	
Electric Connection	13 A Socket	

 **DENFORD**

Vertical Router

LARGE FORMAT VERTICAL 3 AXIS CNC ROUTER



High volume floor standing dust extraction unit.
(Requires single phase, 16A supply protected by either a fuse or an MCB C Type)

The Denford Vertical Router is a large format CNC Router, combining high speed machining over a large working area with space saving engineering. The 1200 x 800 mm working envelope makes it ideal for the manufacture of large-scale items such as furniture parts and door panels. The machine is well equipped with a high power 21,000 rpm spindle motor and AC Servo Motors allowing contouring and rapid feeds of 20 metres per minute in all axes. Inspired design provides excellent production capabilities and ease of installation, as the Vertical Router will fit through a standard door frame.

APPROVED

Ideal for use in conjunction with

IN SCHOOLS

Vertical Router

THE VERTICAL ROUTER COMES AS STANDARD WITH:

- VR CNC Milling Operating Software (PC not included).
- QuickCAM 2D Design software (1 seat)
- Aluminium T Slot Table.
- Outlet for Dust Extraction System.
- Workholding Clamps.
- Installation and Instruction Manuals.
- USB Connection.

KEY FEATURES INCLUDE:

- Incredible 1200 x 800 x 150 mm working area.
- 21,000 rpm spindle motor.
- Fully closed loop servo system for increased machining accuracy.
- 20 metres per minute Feed/Rapid rate.
- Will fit through a standard door frame.

OPTIONAL EQUIPMENT INCLUDES:

Large Format Vacuum Bed, Hinged Arm Computer Shelf, Dust Extraction Unit, F1 in Schools Car Manufacturing Fixture, 4th Axis Programmable Rotary Fixture, and Workholding Clamps.

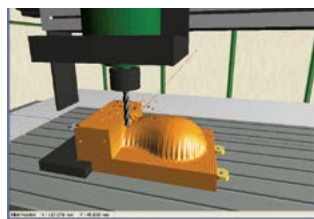
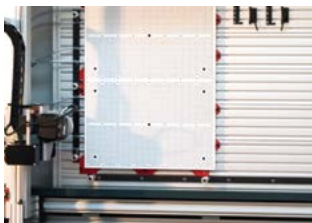

SYSTEM REQUIREMENTS

Please refer to page 29.

RECOMMENDED SOFTWARE PROGRAMS

All software necessary to control the Vertical Router is included. Also included is a seat of QuickCAM 2D Design - an easy to use 2D CAD package.

- 2D Designs: The VR Milling software can import DXF, DWG, EPS and Gerber files in addition to G & M code programs and as such will link with programs such as Techsoft 2D Design and CorelDraw.

- 3D Designs: To enable import of STL files from 3D design packages such as Autodesk Inventor, SolidWorks, Pro/DESKTOP & ArtCAM, QuickCAM Pro software is required (see pages 40 - 41).

MECHANICAL DETAILS	VERTICAL ROUTER
Machine Width	2200mm
Machine Depth	750mm
Machine Height	1920mm
Machine Weight	450kg
Table Size	1300 x 900mm
Travel X Axis	1200mm
Travel Y Axis	800mm
Travel Z Axis	150mm
Max. Spindle Speed	21,000rpm
Feed Rate (all axes)	20 metres/min
Mains Supply Requirements* [* Alternative supplies available on request]	Single Phase
Spindle Motor	1.7kW
Axes Motors	Servo
Volts	230 Volts
Amps	13 Amps
Hz	50 Hz
Electrical Connection	16A Hard Wired

Router Accessories

FLOATING HEAD, AUTOMATIC TOOL CHANGERS, VACUUM BEDS, CLAMPING KITS, FIXTURES AND DUST EXTRACTION UNITS

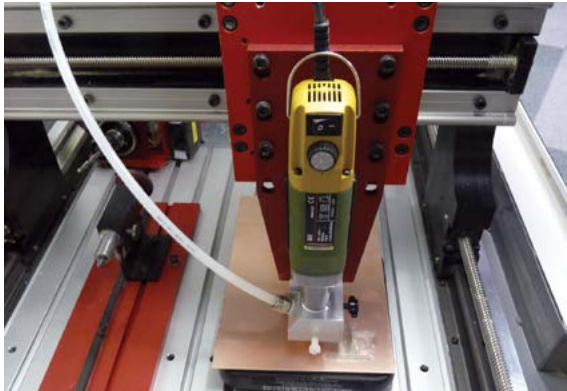

PCB Production with a Floating Head

Denford's 'Floating Head' option permits manufacture of PCB's and engraving of uneven surfaces, and is ideal for batch manufacture of PCB boards.

The floating head comes complete with a quick change facility for a swift interchange with the standard issue router motor.

The cutting tool profiles around the outside of the tracks creating an isolation gap. The weight of the spindle motor plunges the cutter into the PCB board, and depth is set by a plastic disc that floats on the material surface. A float up to 5mm is possible using this technology.

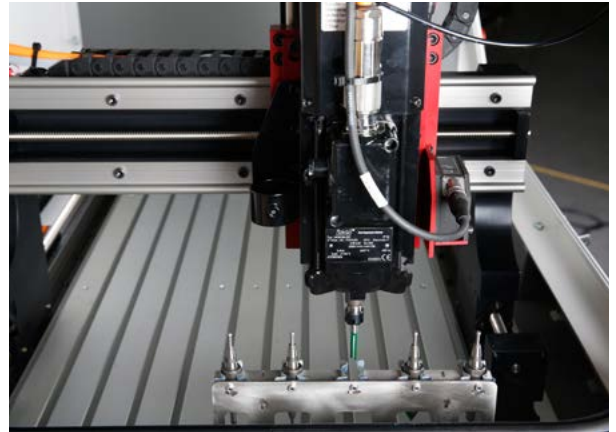

5 STATION AUTOMATIC TOOL CHANGER

The 5 Station Automatic Tool Changer is now **supplied as standard** on the new Router 2600 ATC and Router 6600 ATC and is NOT available as an optional accessory. It comes complete with 5 SK11 Toolholders and 8 collets and offers the following benefits:

- Saves time wasted in repeatedly setting tool offsets
- No additional software required as the 5 station ATC is compatible with all Denford 2D and 3D software



DUST PRO 100 EXTRACTION UNIT

Denford's Large Capacity Dust Extraction system is a purpose-designed dust control system for use with the MRC 40, Compact 1000 Pro, Router 2600/Pro/ATC & Router 6600/Pro/ATC. It can be used as a stand-alone unit, or incorporated within Denford's Universal Machine Bench, as shown above.

The unit is highly effective in removing airborne dust and light particles produced during machining, and is recommended for schools where MDF is regularly used. The unit comes ready to use including a removable / reusable dust collection bag and separate HEPA filter.

Dimensions: H530mm W460mm D670mm
H20.87in W18.11in D26.38in



DUST PRO 50 EXTRACTION UNIT

Particle and dust extraction unit suitable for use with the MRC 40, Compact 1000 Pro and Router 2600/Pro/ATC. This purpose designed unit is ideal for extraction of airborne dust created during the manufacturing process, and also to vacuum the machine after the cutting process is complete.

The unit comes complete with castors, flexible hose and fittings.

Dimensions: H530mm W300mm D300mm
H20.87in W11.81in D11.81in

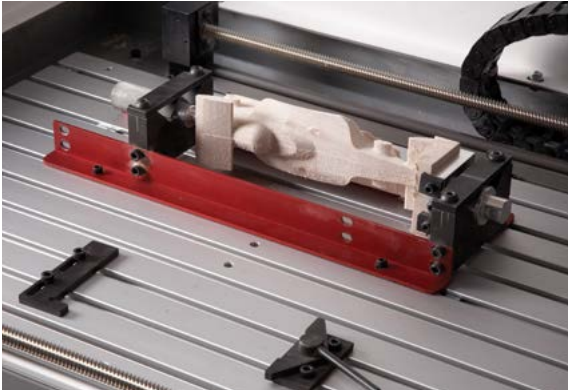

F1 IN SCHOOLS CAR FIXTURE

The F1 in Schools Car Manufacturing Fixture comes as standard with 2 clamping systems to enable the manufacture of Bloodhound SSC and Formula 1® Class cars. The fixture clamps directly to the T-slotted table on the MRC 40*, Compact 1000 Pro, Router 2600/Pro/ATC, Router 6600/Pro/ATC and Vertical Router. It is also suitable for use on the VMC 1300.

*T-slotted table not standard equipment with MRC 40.



ADDITIONAL CLAMPING KIT

Additional Clamping Kit includes 2 Parallel Clamping Rails with T-Nuts, (allowing the workpiece to be raised from the bed, to permit 'through' machining), 1 additional L Bracket and Lever Clamp with T-Nuts.



LARGE FORMAT VACUUM BED

Suitable for use with the Router 2600/Pro/ATC, Router 6600/Pro/ATC and the Vertical Router, the large format bed is supplied with an external vacuum pump. Suitable for 'blind' machining and 'through' machining when used with sacrificial mat.

It is available in 2 sizes:

- 600 x 400mm - 23.62 x 15.75in: Router 2600/Pro/ATC, Router 6600/Pro/ATC.
- 1000 x 600mm - 39.37 x 23.62in: Router 6600/Pro/ATC [as shown above] and Vertical Router.

Requires single phase, 16A supply protected by either a fuse or an MCB C Type



VACUUM PADS

Vacuum Pads are suitable for the MRC 40, Compact 1000 Pro, Router 2600/Pro/ATC and Router 6600/Pro/ATC. The package includes 2 vacuum pads and an integral vacuum pump.

Suitable for 'blind' machining only.



EasySCAN 3D Scanner

3D SCANNING ATTACHMENT & SOFTWARE FOR DENFORD ROUTERS

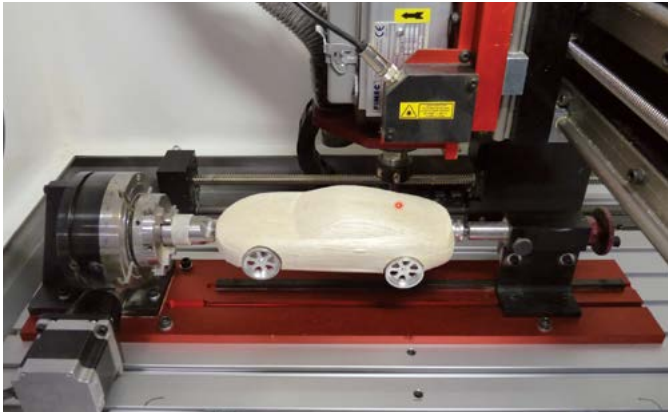

1. Select and scan the model

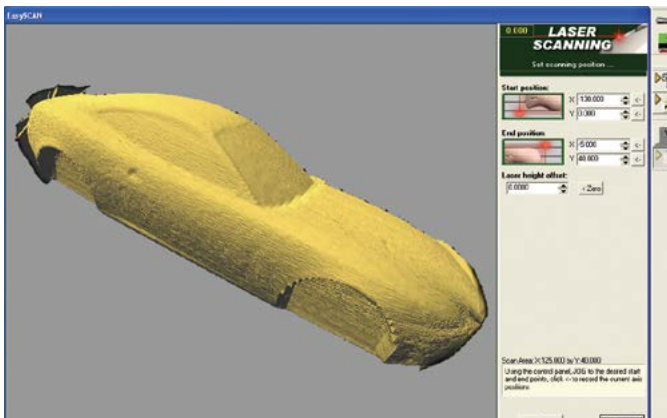

2. Manipulate scan data



3. Manufacture on a Denford CNC Router



4. Completed model

Denford's EasySCAN 3D Scanner attachment has full 360 degree scanning capability when used in conjunction with Denford's Rotary Fixture, and is suitable for use with the entire range of Denford CNC Routers.

The EasySCAN 3D package incorporates user friendly, wizard based software for scanning, editing and saving 3D models, prior to manufacture on a Denford CNC Router.

EasySCAN 3D is ideal for Reverse Engineering applications.

3D Scanning & Manufacturing Package
see pages 66 - 67.

4th Axis Programmable Rotary Fixture

COMPLETE WITH QUICKCAM 4D MILLING SOFTWARE

4TH AXIS PROGRAMMABLE ROTARY FIXTURE

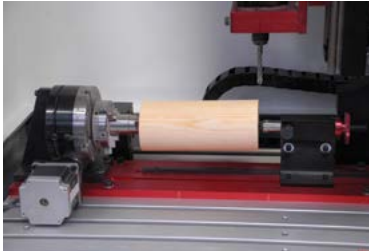

for use with
MRC 40
Compact 1000 Pro
Router 2600/Pro/ATC
Router 6600/Pro/ATC
Vertical Router
(also available for
VMC1300/Pro with the
exception of flood coolant models).

SYSTEM REQUIREMENTS

IBM or 100% Compatible PC,
Pentium III, 1Ghz, 512MB RAM,
200MB Free Hard Disk Space,
Microsoft Windows XP; NT; 2000; Vista; Windows 7, 8
CD-ROM Drive,
OpenGL 3D Accelerator Graphics Card with 128MB
RAM supporting at least 1024 x 768 screen resolution.
CNC Machines require USB Connection.
EasySCAN requires 1 USB Connection

QUICKCAM 4D MILLING SOFTWARE

(Supplied FREE with the Denford 4th Axis Programmable Rotary Fixture.)

An easy to use, wizard based CAM package specifically designed for use with the Denford 4th Axis Programmable Rotary Fixture. QuickCAM 4D Milling imports 3D files from most 3D CAD packages and converts these into 4th axis CNC program data for output to the range of Denford CNC Routers. Users are guided through a series of simple steps, defining billet size, model orientation, machining strategy and axis of rotation before generating the appropriate CNC output file.

QUICKCAM 4D MILLING FEATURES

True 3 Dimensional model-making capabilities. Seamless integration with VR CNC Milling software. Circular, spiral and linear machining strategies. User definable limits allow for workholding avoidance. Supports both roughing and finishing paths. Resize, orientate and centre the model. Autoscale of model to fit the workpiece.

SUPPORTED OUTPUT FORMATS

CNC controllers for Denford CNC Routers.

SUPPORTED INPUT FORMATS

3D Stereo Lithography *(STL) files

*Used by 3D design packages such as Autodesk Inventor, Solid Works, Pro/DESKTOP and ArtCAM.

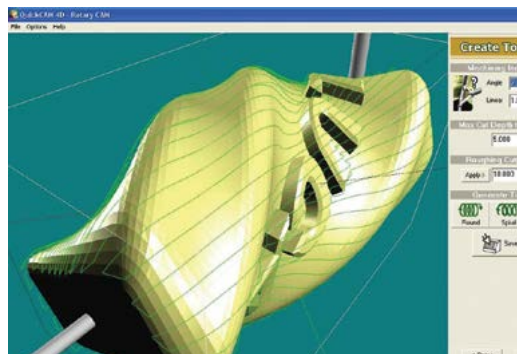
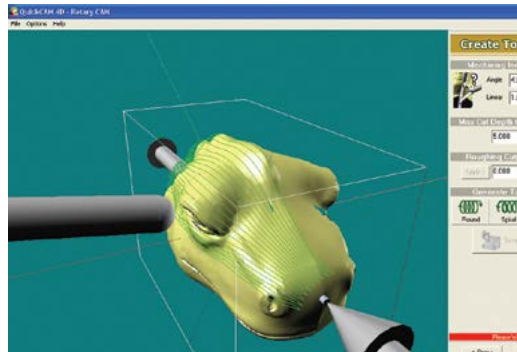

DENFORD

VMC 1300/1300 PRO

CNC MILLING MACHINE



AVAILABLE WITH:

- Flood Coolant & Industrial Cabinet Base
- 6 or 8 Station Automatic Tool Changer
- Automatic Lubrication System

Shown with optional universal bench and optional computer support extension. (PC not included)

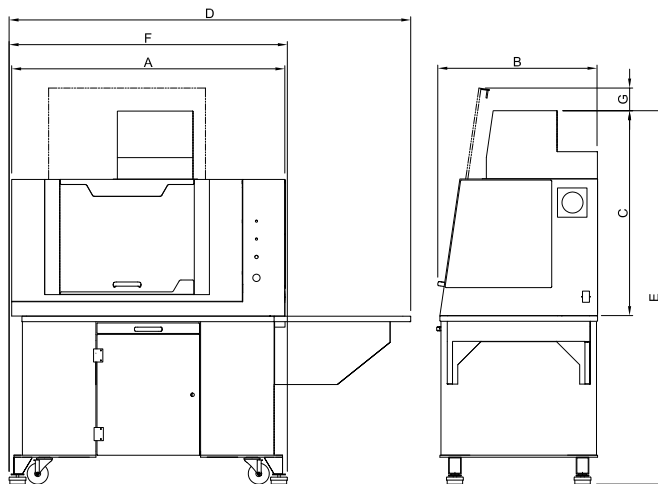

Machine Dimensions.

A 3 axis CNC milling machine available either floor standing or for bench mounting, with totally enclosed high visibility interlocking guard, suitable for all levels of education and training. Programmable spindle speeds and feedrates make the VMC 1300 ideal for cutting a range of resistant materials such as wax, plastic, acrylic, free cutting alloys, aluminium and steel. The VMC 1300 Pro has a more powerful, higher speed spindle (6000 rpm) for heavy duty cutting. Now available with 6 or 8 Station Automatic Tool Changer and the option of Flood Coolant with Industrial Cabinet Base.



VMC 1300/1300 PRO

THE VMC 1300/1300 PRO COME AS STANDARD WITH:

- VR CNC Milling Operating Software (PC not included).
- QuickCAM 2D Design software (1 seat)
- Power Drawbar with Manual Actuation.
- Workholding Clamps
- Installation and Instruction Manuals.
- USB Connection.

NB The Flood Coolant model comes complete with Industrial Cabinet Base

OPTIONAL EQUIPMENT INCLUDES:

Table Mounted 6 or 8 Station Automatic Tool Changer (which can be removed to enable full 375mm X axis travel), Pneumatic Vice and Guard, Spray Mist Coolant, Automatic Lubrication System and 4th Axis Programmable Rotary Fixture (not available with flood coolant model).



SYSTEM REQUIREMENTS

Please refer to page 29.

RECOMMENDED SOFTWARE PROGRAMS

All software necessary to control the VMC 1300/1300 Pro is included. Also included is a seat of QuickCAM 2D Design - an easy to use 2D CAD package.

• 2D Designs: The VR Milling software can import DXF, DWG, EPS and Gerber files in addition to G & M code programs and as such will link with programs such as Techsoft 2D Design and CorelDraw.

• 3D Designs: To enable import of STL files from 3D design packages such as Autodesk Inventor, SolidWorks, Pro/DESKTOP & ArtCAM, QuickCAM Pro software is required [see pages 42 - 43].

MECHANICAL DETAILS	VMC 1300	VMC 1300 PRO
Machine Length (A)	1300mm	
Machine Depth (B)	750mm	
Machine Height (C)	1325mm	
Length with Optional PC Arm (D)	1910mm	
Machine Height with Optional Base (E)	1765mm	
Machine Length with Optional Base (F)	1330mm	
Additional Height door open (G)	65mm	
Machine Weight	353kg	
Machine Weight with Opt. Base	456kg	
Table Size	600 x 180mm	
Travel X Axis Without ATC	375mm	
Travel X Axis With ATC Fitted	250mm	
Travel Y Axis	160mm	
Travel Z Axis	235mm	
Table to Spindle	305mm	
Max. Spindle Speed	4000rpm	6000rpm
Max. Feed Rate	5000mm/min	
Max. 3D Profiling	4500mm/min	
Mains Supply Requirements* [* Alternative supplies available on request]	Single Phase	
Spindle Motor	1.1kW	1.6kW
Axes Motors	Stepper	
Volts	230VAC	
Amps	8 Amps	10 Amps
Hz	50 Hz	
Electric Connection	13A Socket	

DENFORD

Turn 270 PRO

CNC LATHE



Shown with optional universal bench and computer support extension. (PC not included)

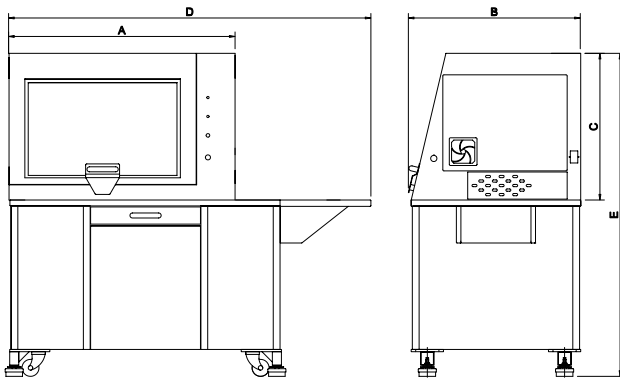

Machine Dimensions.

A compact 2 axis CNC Lathe with totally enclosed high-visibility interlocking guard, suitable for all levels of education and training. Programmable spindle speeds and feedrates make the Turn 270 PRO ideal for cutting a range of resistant materials such as wax, plastic, acrylic, free cutting alloys, aluminum and steel.

Turn 270 PRO

THE TURN 270 PRO COMES AS STANDARD WITH:

- VR CNC Turning Operating Software (PC not included).
- QuickTURN 2D Design software (1 seat)
- Quick Change Toolpost and Holder.
- Manual Self Centring 100mm 3 Jaw Chuck.
- Installation and Instruction Manuals.
- USB Connection

OPTIONAL EQUIPMENT INCLUDES:

Comprehensive Tooling Package, 8 Station Programmable Turret, Pneumatic Chuck and Guard, Spray Mist Coolant, Automation Lubrication System, Tail Stock, and Universal Machine Bench.



SYSTEM REQUIREMENTS

IBM or 100% Compatible PC,
Pentium III, 1Ghz, 512MB RAM,
200MB Free Hard Disk Space,
Microsoft Windows XP; NT; 2000; Vista; Windows 7, 8
CD-ROM Drive,
OpenGL 3D Accelerator Graphics Card with 128MB RAM
supporting at least 1024 x 768 screen resolution.
CNC Machines require USB Connection.

RECOMMENDED SOFTWARE PROGRAMS

All software necessary to control the Turn 270 PRO is included. Also included is a seat of QuickTURN 2D Design - an easy to use CAD package.

MECHANICAL DETAILS	TURN 270 PRO
Machine Length [A]	1000mm
Machine Depth [B]	768mm
Machine Height Bench Mounting [C]	675mm
Length with Optional Base [D]	1665mm
Height with Optional Base [E]	1440mm
Machine Weight	140kg
Machine Weight with Optional Base	255kg
Swing Over Bed	190mm
Swing Over Cross Slide	100mm
Distance Between Centres	270mm
Travel X Axis	150mm
Travel Z Axis	225mm
Max. Spindle Speed	4000rpm
Max. Feed Rate	3000mm/min
Spindle Bore	26mm
Mains Supply Requirements* [* Alternative supplies available on request]	Single Phase
Spindle Motor	1.5kW
Axes Motors	Stepper
Volts	230VAC
Amps	8 Amps
Hz	50 Hz
Electrical Socket	13A Socket

DENFORD

Turn 370 PRO

HIGH CAPACITY CNC LATHE

COMPLETE WITH
FLOOD COOLANT
AND INDUSTRIAL
CABINET BASE



Shown with optional
computer support extension
(PC not included)

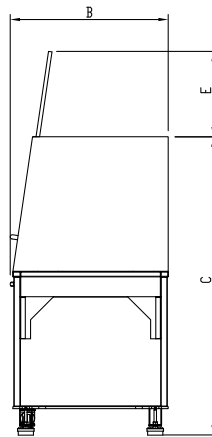
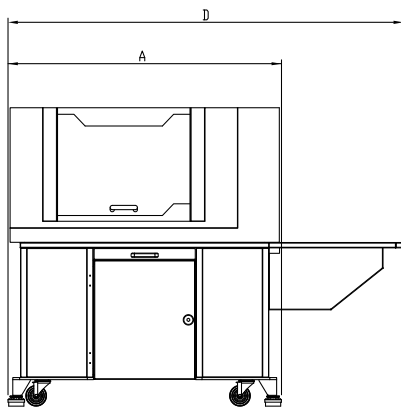

Machine Dimensions.

A high capacity 2 axis CNC Lathe complete with flood coolant and industrial cabinet base and totally enclosed high-visibility interlocking guard, suitable for all levels of education and training. Programmable spindle speeds and feedrates make the Turn 370 PRO ideal for cutting a range of resistant materials such as wax, plastic, acrylic, free cutting alloys, aluminum and steel.

Turn 370 PRO

THE TURN 370 PRO COMES AS STANDARD WITH:

- VR CNC Turning Operating Software (PC not included).
- QuickTURN 2D Design software (1 seat)
- Flood Coolant and Industrial Cabinet Base.
- Quick Change Toolpost and Holder.
- Manual Self Centring 125mm 3 Jaw Chuck.
- Installation and Instruction Manuals.
- USB Connection

SYSTEM REQUIREMENTS

IBM or 100% Compatible PC,
Pentium III, 1Ghz, 512MB RAM,
200MB Free Hard Disk Space,
Microsoft Windows XP; NT; 2000; Vista; Windows 7, 8
CD-ROM Drive,
OpenGL 3D Accelerator Graphics Card with 128MB RAM
supporting at least 1024 x 768 screen resolution.
CNC Machines require USB Connection.

RECOMMENDED SOFTWARE PROGRAMS

All software necessary to control the Turn 370 PRO is included. Also included is a seat of QuickTURN 2D Design - an easy to use CAD package.

OPTIONAL EQUIPMENT INCLUDES:

8 Station Programmable Turret (supplied in lieu of Quick Change Toolpost), Pneumatic Chuck and Guard, Tail Stock and Automatic Lubrication System.



MECHANICAL DETAILS	TURN 370 PRO
Machine Length (A)	1330mm
Machine Depth (B)	750mm
Machine Height (C)	1445mm
Length with Optional PC Arm (D)	1910mm
Open Door Height Above Machine (E)	385mm
Machine Weight	400kg
Swing Over Bed	260mm
Swing Over Cross Slide	105mm
Distance Between Centres	370mm
Travel X Axis	200mm
Travel Z Axis	275mm
Max. Spindle Speed	3700rpm
Max. Feed Rate	3000mm/min
Spindle Bore	35mm
Mains Supply Requirements* [* Alternative supplies available on request]	Single Phase
Spindle Motor	2.2kW
Axes Motors	Stepper
Volts	230VAC
Amps	16 Amps
Hz	50 Hz
Electrical Socket	16A MCB Protected



Micromill

CNC MILLING MACHINE

Microturn

CNC LATHE



Benches on this page are no longer available and are shown for illustration purposes only.

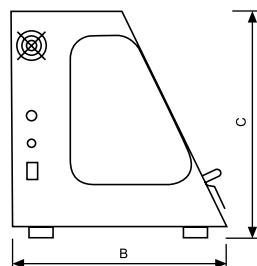
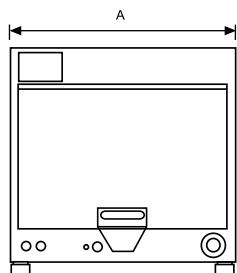

Machine Dimensions.

A compact 3 axis CNC milling machine and 2 axis CNC lathe, both with totally enclosed interlocking guards - the ideal introduction to small part CNC manufacture. Variable spindle speeds and feedrates make the Micromill and Microturn ideal for cutting resistant materials such as wax, plastic, acrylic, aluminum and free cutting alloys.



Micromill / Microturn

THE MICROMILL COMES AS STANDARD WITH:

- VR CNC Milling Operating Software (PC not included).
- Maintenance Tools.
- Clamping Kit.
- 1/4" Dia Milling Collet.
- 5/16" Dia Drawbar.
- 3/16" Slot Drill 1/4" Shank.
- Installation and Instruction Manuals.
- Set of Metric Allen Keys.

THE MICROTURN COMES AS STANDARD WITH:

- VR CNC Turning Operating Software (PC not included).
- Maintenance Tools.
- 1 1/2" Standard Toolpost.
- Tailstock.
- 3" Dia Spindle Faceplate.
- No. 1 Morse Taper, Spindle Centre.
- No. 0 Morse Taper, Tailstock Centre.
- 2 1/2" Dia 3 Jaw Chuck & 2 Tommy Bars.
- 1/4" Braised Carbide Tip Cutting Tool, Right Handed.
- Installation and Instruction Manuals.

SYSTEM REQUIREMENTS

For both Micromill and Microturn please refer to page 29.

OPTIONAL EQUIPMENT INCLUDES:

MICROMILL

Tooling Package, Milling Vice,

MICROTURN

Toolpost and Tooling Package, Thread Cutting Package.

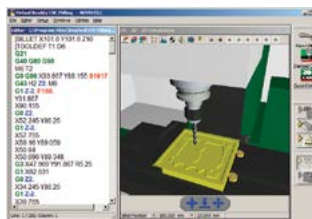
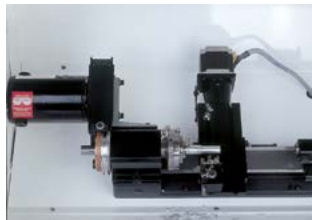
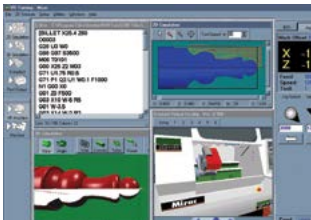

MECHANICAL DETAILS	MICROMILL	MICROTURN
Machine Length (A)	685mm	685mm
Machine Depth (B)	654mm	654mm
Machine Height (C)	688mm	688mm
Machine Weight	50kg	57kg
Table Size	70x330mm	n/a
Swing Over Bed	n/a	90mm (150mm opt)
Travel X Axis	228mm	50mm
Travel Y Axis	130mm	n/a
Travel Z Axis	160mm	126mm
Table to Spindle	182mm	n/a
Max. Spindle Speed	2500rpm	2500rpm
Max. Feed Rate	750mm/min	600mm/min
Max. 3D Profiling	600mm/min	n/a
Mains Supply Requirements* [* Alternative supplies available on request]	Single Phase	Single Phase
Spindle Motor	0.075kW	0.075kW
Axes Motors	Stepper	Stepper
Volts	230VAC	230VAC
Amps	8 Amps	8 Amps
Hz	50 Hz	50 Hz
Electrical Connection	13A Socket	13A Socket

DENFORD

Universal Machine Benches



**Universal Machine Bench
VMC/0600B**
(For Router 2600/Pro, Router 2600 ATC,
VMC1300/Pro)

Shown with optional computer
support extension.
(PC not included)



Universal Machine Bench VMC/0600WB
(Stand alone bench)

Denford's Universal Machine Benches are suitable for use with our entire range of CNC Routers, Mills and Lathes. The benches are designed to accommodate varying requirements, and to integrate with existing furniture in a traditional workshop environment, or an IT suite.



Universal Machine Benches

The Universal Machine Bench comes with wheels, anti-vibration pads, storage cupboard, tooling drawer and is suitable for a range of bench top machines including:-

VMC 1300, Router 2600/Pro, Router 2600 ATC

Optional - Computer Support Extension
Optional - Integrated Dust Pro 100

Product Code: VMC/0600B
Product Code: VMC/0602
Product Code: ADVXU

MRC 40, Compact 1000 Pro

Includes - Computer Support Extension
Optional - Integrated Dust Pro 100

Product Code: MRCWB
Product Code: ADVXU

Turn 270 Pro

Includes - Computer Support Extension

Product Code: TRNWB

Stand-Alone Workbench

Optional - Computer Support Extension
Optional - Integrated Dust Pro 100

Product Code: VMC/0600WB
Product Code: VMC/0602
Product Code: ADVXU

Bench Size: 1330mm x 750mm x 790mm (WxDxH)

Colour: Grey

Weight: 103kg (with integrated dust extraction unit 163kg)



Universal Machine Bench VMC/0600WB
Shown with integrated Dust Pro 100.

DENFORD

Machine Refurbishment

REFURBISHMENT AND RE-WARRANTY PACKAGE

Let Denford Refurbish your Machine and Return it with a Full 1 Year Warranty!



NOVAMILL ATC BEFORE



NOVAMILL ATC AFTER



Denford's State-of-the-Art Workshops

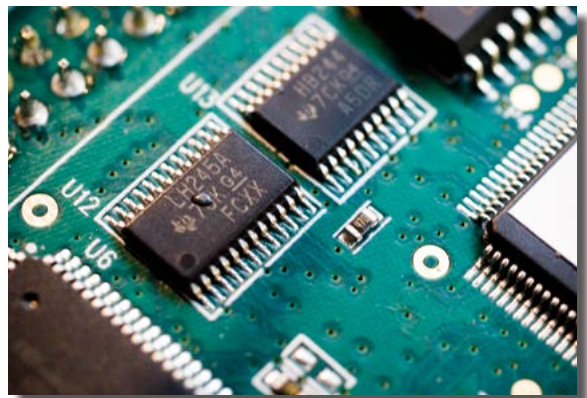

Upgrade to Latest CNC Technology

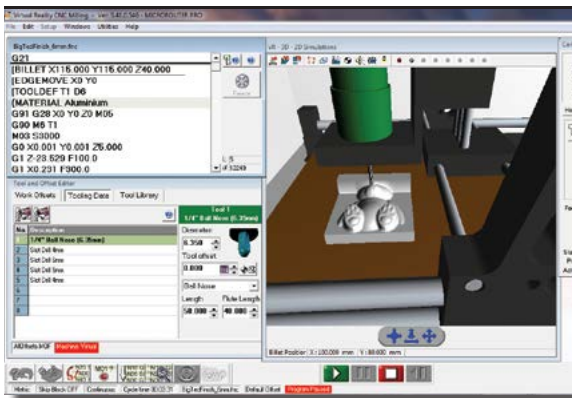

Latest VR CNC Machine Control Software

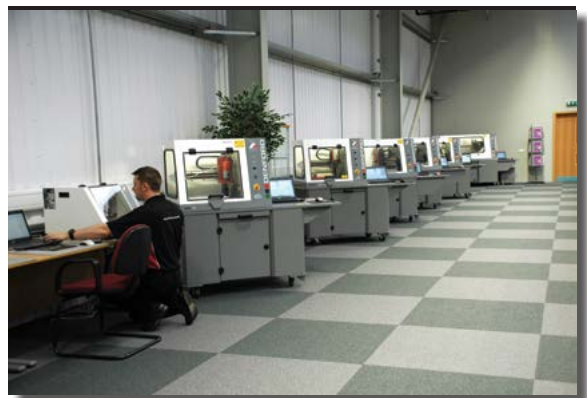

Training at Denford and 1 Year Warranty

Machine Refurbishment

The Denford Refurbishment & Re-Warranty Package provides a complete refurbishment with 1 year warranty for your existing Denford machine(s) and offers huge savings on the cost of a new machine.

THE REFURBISHMENT PACKAGE INCLUDES:

- Mechanical/electrical service/inspection.
- Replacement of serviceable items, where necessary.
- Replacement of guards/side windows and new labels fitted.
- Upgrade to Nextmove technology with USB connectivity, where applicable.
- Supply of latest versions of VR Milling V5 and QuickCAM 2D Design for Routers and Novamill.
- Supply of latest versions of VR Turning and QuickTURN 2D Design for Novaturn.
- One day training course at Denford for 2 people. (Does not include travel costs or local expenses)
- Machines will be cleaned (not repainted).
- Novaturns and Novamills will be fitted into new cabinets with integral electronics.
- 1 year parts only warranty.

Subject to inspection and approval, we are able to refurbish the following Denford machines:



**Microrouter
Compact**



**Microrouter
V3 & V4 / Pro**



**Compact
1000 / Pro**



**Router
2600 / Pro**

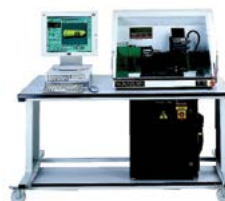

Novaturn

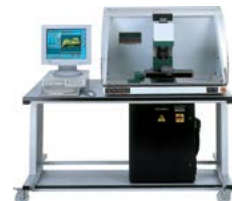

Novamill / ATC

PACKAGE DETAILS	PRODUCT CODE
Microrouter Compact Refurbishment & 1 Year Warranty	RWP0001
Microrouter V3 & V4 / Pro Refurbishment & 1 Year Warranty	RWP0002
Compact 1000 Refurbishment & 1 Year Warranty	RWP0003
Compact 1000 Pro Refurbishment & 1 Year Warranty	RWP0004
Router 2600 Refurbishment & 1 Year Warranty	RWP0005
Router 2600 Pro Refurbishment & 1 Year Warranty	RWP0006
Novaturn Refurbishment & 1 Year Warranty	RWP0007
Novamill / ATC Refurbishment & 1 Year Warranty	RWP0008

Refurbishments will take place at Denford Limited and will be subject to packing and freight charges.

DENFORD

LaserCAM 2D Design

2D DESIGN SOFTWARE FOR LASER CUTTERS

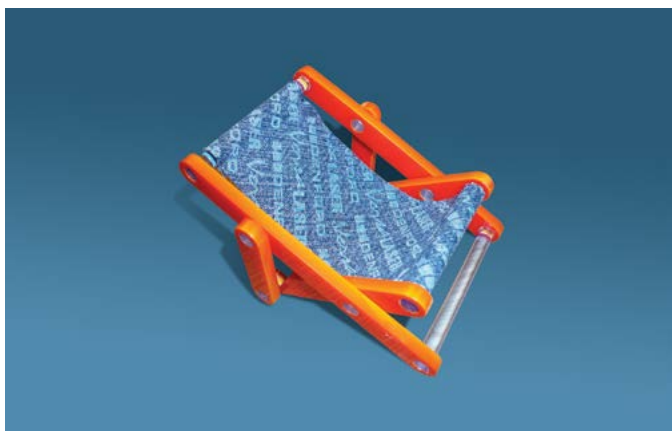
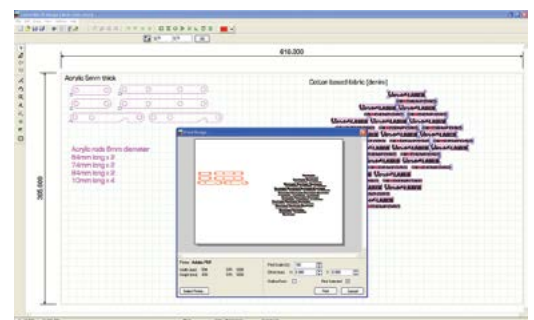
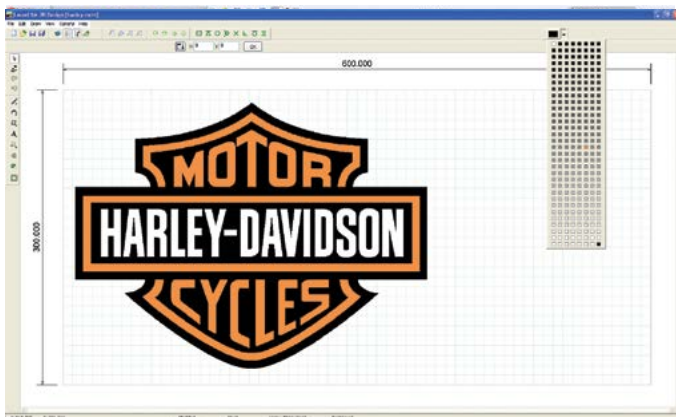
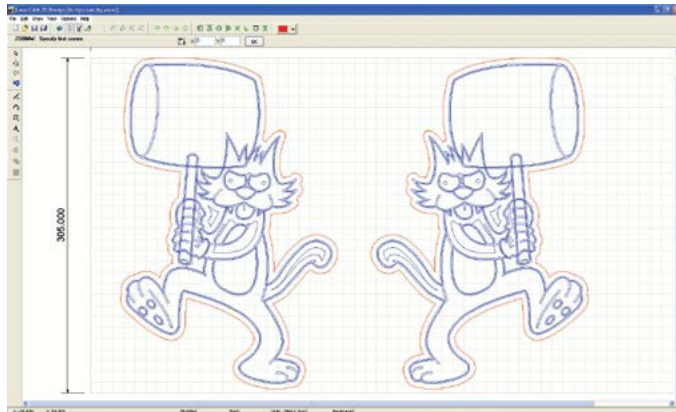

LaserCAM 2D is a 2D CAD solution for use with Laser cutting machines. Simple designs can be created quickly and accurately and output to a laser with minimum effort. A host of import options make it the ideal way to manufacture logos, designs and projects on most types of Laser cutter & engraver.

LaserCAM 2D Design

POWERFUL TOOLS TO MAKE LASER MANUFACTURING EASY

LaserCAM 2D Design has all the features you need for laser cutting / engraving - all in one place. For example, the image importer includes image editing features to adjust brightness, contrast and gamma. The interactive preview and tools to create greyscale, black and white or halftone images will ensure you get the best results every time.

Custom colour palettes make it easy to pick the right colours for the laser driver (e.g. solid blue for vector engraving, solid red for vector cutting, black for raster engraving).

Grid size setup is easy - just click 'Match to Printer' and select the laser driver you're going to use.

Before printing your design, the handy preview window allows you to offset its position and scale, without altering the original. It also gives you the option to only output selected objects.

With a wealth of designs available in postscript (.EPS) and metafile (.WMF, .EMF) formats, you will never be stuck for logos or cool designs!

CAD DRAWING FEATURES

The following objects can be created to exact sizes:

Lines, Arcs, Polylines, Curves, Polygons, Ellipses, Text*, Multi-line Text with justification*, Hatched areas, Offset paths, Bitmap Image Contours.

*Any TrueType font available to Windows™ can be installed and used by LaserCAM

Drawing features allow easy creation and manipulation of objects:

Customisable grid size for snapping to fixed distances, Editable object nudge, Angular [polar] snap, Absolute and relative co-ordinate entry, Object property editor allows sizes, angles and positions to be entered exactly, Quick drawing navigation (pan & zoom) is realised by mouse

wheel operation, Object grips can be grabbed and moved, Various object snap modes can be activated at any time: End point; Mid point; Nearest; Intersection; Tangent; Perpendicular

Object modifiers allow objects to be altered quickly and accurately:

Move, Scale, Rotate, Mirror, Copy, Paste, Join, Explode, Group and Ungroup, Customisable colour palettes for easy configuration to match the Laser driver, Rectangular array, Circular array, Boolean shape operators: Union; Intersect; Split; Subtract.

IMPORT/EXPORT FEATURES

Import:

- Raster Images: .JPG; .BMP; .ICO; .EMF; .WMF
- Clipboard paste from other drawing packages such as CorelDraw.
- PCB Gerber file (RS274X).
- AutoCAD: .DWG and .DXF (versions up to 2000).
- Vector image clipart metafiles: .WMF and .EMF
- Fonts: True type .TTF font files.
- Encapsulated PostScript: .EPS vector files.

Export:

- AutoCAD: .DXF files can be saved.
- QuickCAM 2D Design: .MCM files saved in LaserCAM can also be opened in QuickCAM 2D for CNC machining.

SYSTEM REQUIREMENTS

IBM or 100% Compatible PC,

Pentium III, 1Ghz, 512MB RAM,

200MB Free Hard Disk Space,

Microsoft Windows XP; NT; 2000; Vista; Windows 7, 8

CD-ROM Drive,

OpenGL 3D Accelerator Graphics Card with 128MB RAM supporting at least 1024 x 768 screen resolution.

CNC Machines require USB Connection.

DENFORD

QuickCAM 2D Design

2D DESIGN & MANUFACTURE SOFTWARE

**ADVANCED V-CARVE
EXTENSION
NOW AVAILABLE**

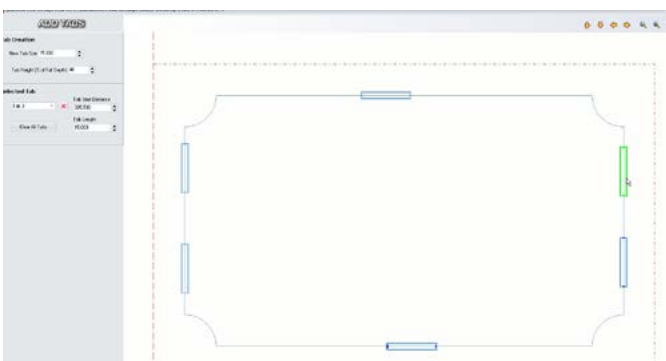
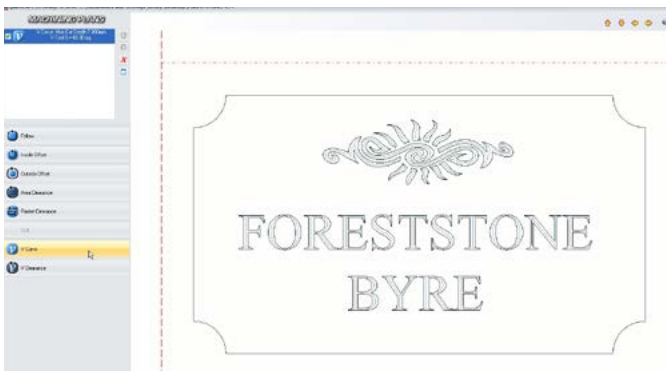

QuickCAM 2D Design is an advanced, yet simple to use, wizard based 2D CAD/CAM package. You can create designs quickly and accurately, then run the CAM wizard to create CNC machine toolpaths. It features various import options to allow images, PCB's and designs from other CAD packages to be manufactured. The customisable post processor and advanced printing facilities provide outputs to most desktop CNC and laser machines.

QuickCAM 2D Design

CAD DRAWING FEATURES

Shape Creation:

Line, Polyline, Rectangle, Curve/Spline, Circle, Arc, Point, Polygon, Ellipse, Text, Multiple Line Text with Justification, Hatch, Offset Path, Image Outline (Contrast Edge Detection).

Drawing Help:

Customisable Grid Size, Grid Snap, Object Nudge, Polar Snap, Absolute and Relative Co-ordinate Entry, Shape Property Editors, Fast Drawing Navigation. Snap Modes: End, Middle, Nearest, Intersection, Tangent.

Shape Modification:

Unlimited Undo and Redo, Move, Scale, Rotate, Mirror, Copy, Paste, Join, Explode, Group and Ungroup multiple shapes, Apply colour to any shape, Modify shape using grips or by property editor, Boolean shape operations: Union, Intersect, Split, Subtract, Rectangular Repeat, Circular Repeat.

Automatic Island Recognition:

Selects whether shapes within shapes are machined on the inside or the outside. Each island's level (ie, inside or outside) can be altered manually.

IMPORT/EXPORT FEATURES

Import

- Raster Image - JPG,BMP,ICO,EMF,WMF.
- Clipboard Vector paste (eg from CorelDraw)
- Gerber (RS274X) - PCB designs are imported and converted into polylines.
- Autocad drawings (DWG,DXF) - drawings can be imported (Autocad versions 2.5 through to 2000).
- Vector Image Clipart - WMF, EMF.
- Font - any Truetype Font (TTF) can be imported then used by the software.

Export

- Autocad DXF versions 10 through to 2000.
- Custom file format for loading and saving design, machining plans and images.

CAM WIZARD FEATURES

Material selector - customisable materials define cutting feeds, speeds and cutting depth.

Machining plans - easily create and rearrange any number of machining plans from the following types:

- Follow - follow the shapes path ideal for Engraving and Laser Cutting.
- Inside Offset - offset cutter path inside shape(s) with automatic island recognition.
- Outside Offset - offset cutter path outside shape(s).
- Area Clearance - multiple offset cutter paths inside the shape(s).
- Raster Clearance - create a raster path at any angle to clear the inside of shape(s).
- Drill - select point, circle or arc centres for drilling operations.

Post Process - final tool path can be simulated quickly in 2D then posted (G code) to a variety of machines via the customisable post processor.

NEW

V-CARVE EXTENSION

The advanced V-Carve extension is available at additional cost. This addition to the standard QuickCAM 2D Design package enables 3 additional CAM features:-

- **V-Carve** – allows shapes and text to be machined at the correct width by automatically controlling the depth of cut of the V cutter.
- **V-Carve Clearance** – allows larger shapes (wider than the V cutter) to be machined by adding an area clearance path within the shape.
- **Add Tabs** – allows parts to be retained while cutting through a billet. The size, number and depth of the Tabs can be user-defined.

SYSTEM REQUIREMENTS

See page 43.

DENFORD

QuickCAM PRO

ADVANCED MILLING CAM SOFTWARE

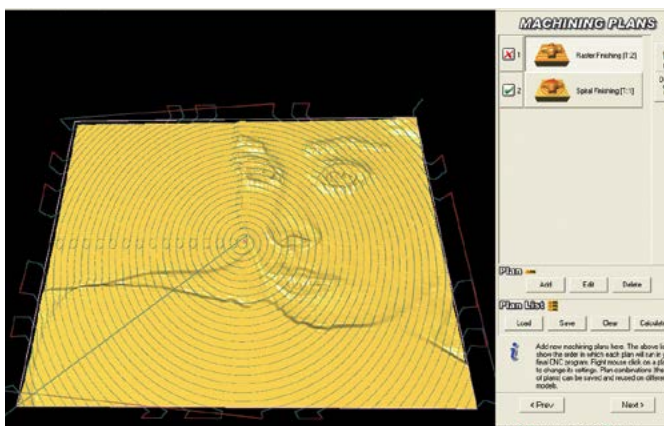
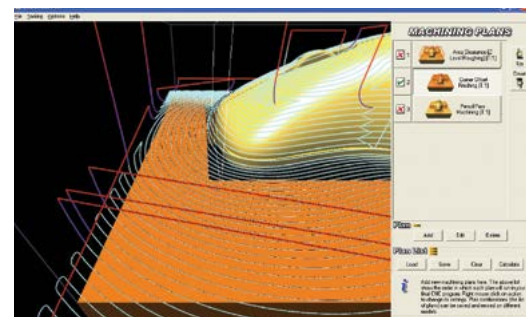
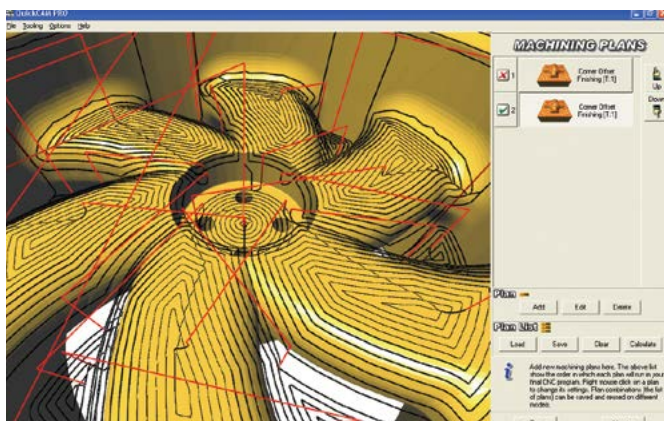
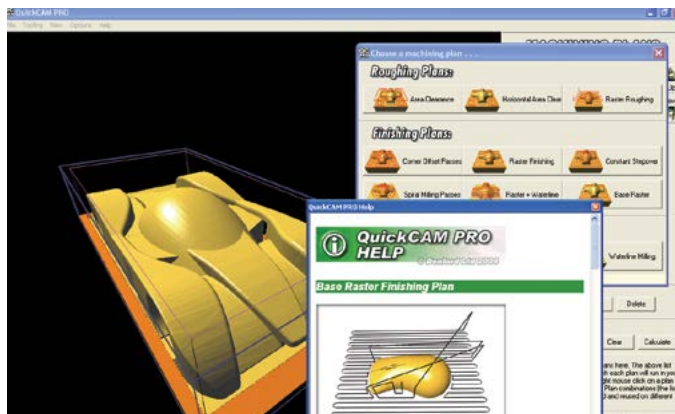

QuickCAM Pro is an advanced, yet simple to use, wizard based CAM package, which is used to create cutter paths for machining 3D parts on a milling machine or router. Both STL files and image files can be imported into QuickCAM Pro, and a comprehensive set of machining plans can be used individually or in combination to produce complex 3D surfaces and lithophanes.

QuickCAM PRO

FEATURES

12 machining plans – use individually or in combinations:

- **3 Roughing Plans.**
- **6 Finishing Plans.**
- **3 Fine Finishing Plans.**

Each plan can be customised or used with default values.

Any number of plans can be used to produce the final part.

Different cutters can be used with each plan.

Simulation mode can be toggled on or off for easy viewing.

Custom boundary feature allows selected area to be machined.

Viewer and simulation colours can be selected and changed.

Finished models can be rendered in custom materials.

Intelligent scaling fits model into billet or billet around model.

Comprehensive “show me” files to provide Help options.

SUPPORTED INPUT FORMATS

3D Stereo Lithography* (STL) files.

* Used by Pro/DESKTOP, ArtCAM, Autodesk Inventor and Solid Edge.

AutoDesk 3D Studio Files (3DS).

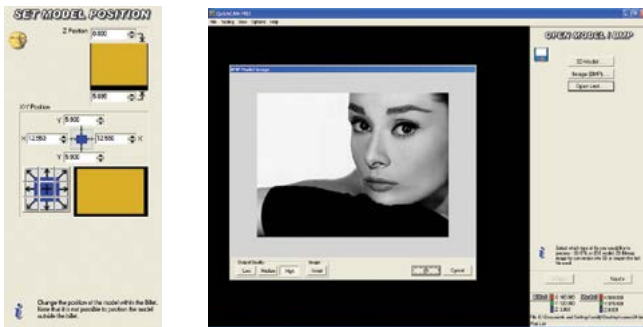
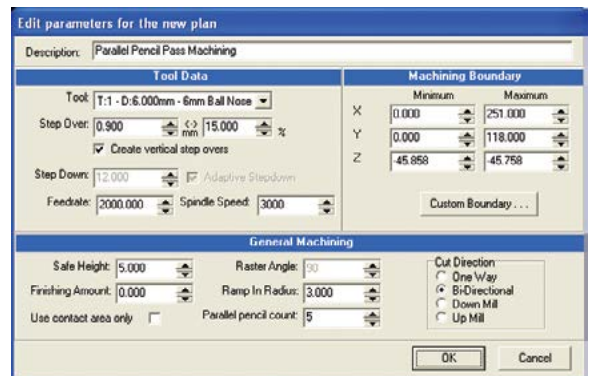

SYSTEM REQUIREMENTS

IBM or 100% Compatible PC,

Pentium III, 1Ghz, 512MB RAM,

200MB Free Hard Disk Space,

Microsoft Windows XP; NT; 2000; Vista;
Windows 7, 8

CD-ROM Drive,

OpenGL 3D Accelerator Graphics Card with
128MB RAM supporting at least 1024 x 768
screen resolution.

CNC Machines require USB Connection.

DENFORD

VR CNC Milling 5

CNC MACHINE CONTROL SOFTWARE

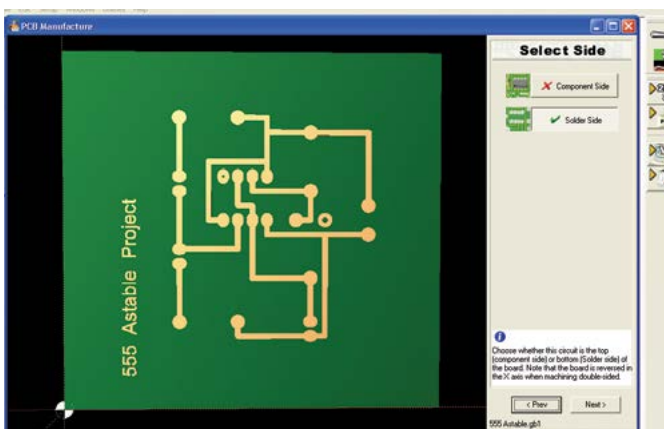
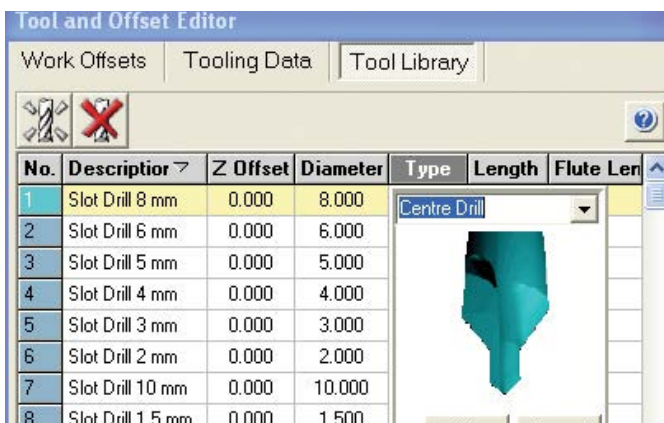
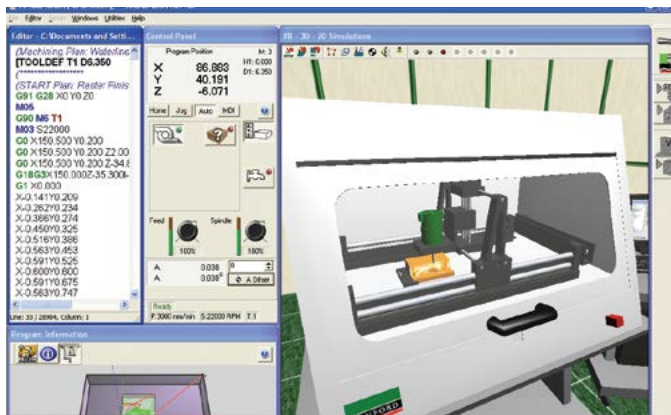

Virtual Reality (VR) CNC Milling 5 is an improved and updated version of our CNC machine control software incorporating Denford PCB Manufacturing Software and 2D DXF import facilities, together with USB connectivity, delivering machining times up to 40% faster than before. Enhanced features provide the user with new machining capabilities, simplified options in datum setting, improved tool and work offset features and a new, powerful, virtual reality 3D simulation engine.

VR CNC Milling 5

PROGRAMMING FEATURES

- Program information screen provides fast interactive 3D depiction of tool path.
- Powerful NC code editing options.
- Program pre-scan checks for syntax errors and invalid codes prior to machining.
- Utilities toolbar provides seamless integration with other Denford applications.
- Simplified tool editing with multiple tool types.

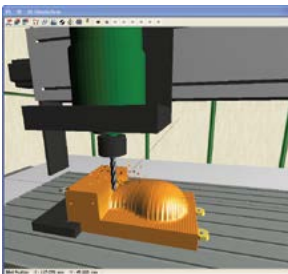

VR SIMULATION FEATURES

- Simulate real machining with highly detailed Virtual Reality.
- Actual cutting of the virtual material in jog mode or program cycle.
- Tables, bases and workholding fixtures are simulated.
- Collision detection: objects change colour when cutter comes into contact with billet, workholding or tables.
- Virtual feed & speed overrides can control the virtual machine.
- Auto datum facility: Program can run without having to set the VR offsets.

MACHINE CONTROL FEATURES

- USB connectivity – Faster Data Transfer.
- Continuous Path Manufacturing system pre-examines CNC moves to determine optimum change of direction.
- One click datum positioning.
- Material override mode – Automatically adjusts program feeds & speeds from a pre-set menu.
- Intelligent program restart window allows restart of program from any line.
- Denford Post Processor allows translation of NC programs between different controllers.

SYSTEM REQUIREMENTS

Please refer to page 43.

VR MILLING PCB IMPORT

Simple "Wizard" program with 3D Graphics. Imports Gerber files from all major PCB design packages. Imports Drill files from all major PCB design packages. Multi pass machining strategy increases clearance around tracks. Option to create drilling plan from pad hole diameters. Option to centre pads, pilot holes or drill all holes. Handles double sided boards. Toolpath simulation.

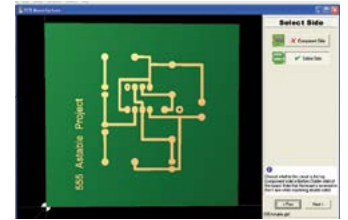
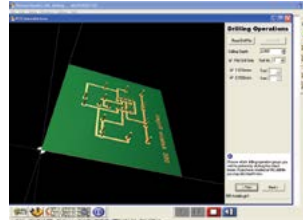

VR MILLING 2D DXF IMPORT

- Simple "Wizard" program with 2D Graphics.
- Integrated Material and Tool Library.
- Imports DXF and DWG files from all major CAD packages:- TechSoft, Pro/DESKTOP, ArtCAM, AutoCAD, CorelDraw etc.
- Multiple cutter path strategies including:
 - Follow Path.
 - Inside Offset [cutter path offset by radius].
 - Outside Offset [cutter path offset by radius].
 - Area Clearance [Offset by outline] with programmable step-over.
 - Area Clearance [Raster] with programmable step over and angle.
 - Drilling cycles.
- Intelligent selection of Islands.
- Toolpath simulation.

SEAMLESS IMPORT OF TECHSOFT 2D DESIGN FILES:

The import routine with Denford's VR CNC Milling V5 operating software works with Techsoft 2D Design Tools Versions 1 & 2 and also with ALL major CAD packages.

It is far more advanced than the Techsoft post-processor, supplied with Techsoft Version 1 and is far simpler to use.

ALL Denford machines operating with VR CNC Milling V5 are able to import designs drawn in Techsoft Versions 1 & 2, saved in DXF format, **without any additional software or post processor being required.**

VR Milling V5 has the facility to import DXF, DWG and Gerber files, which then allows multiple toolpaths to be created. The toolpaths are generated using the vector data imported and not colours, fill or line width.

DENFORD

QuickTURN 2D DESIGN

CAD/CAM DESIGN AND MANUFACTURE
SOFTWARE FOR LATHES

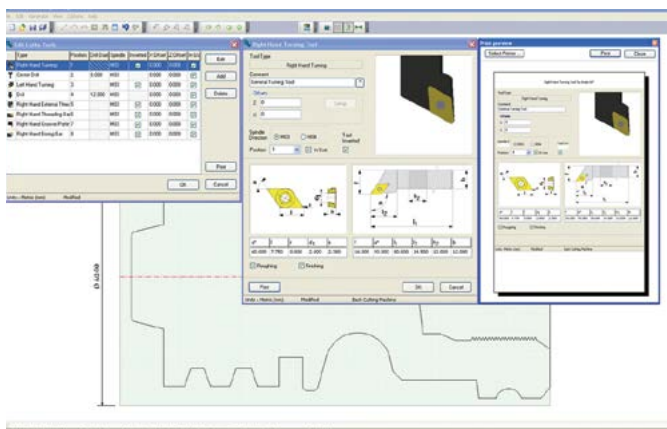
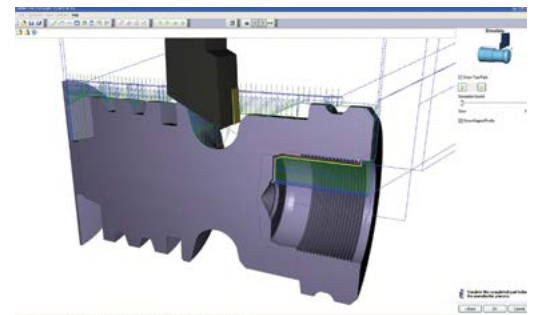
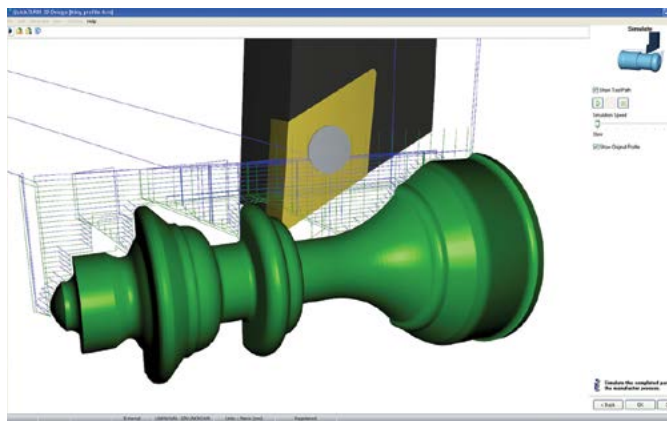
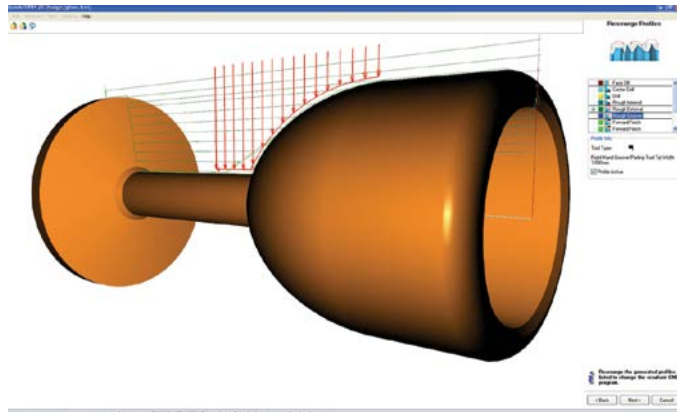

QuickTURN is an advanced yet simple to use, wizard based CAD/CAM package for Lathes. You can create or import 2D profiles, configure your tooling and material settings, then run the CAM wizard to create and simulate CNC Lathe toolpaths. The software features fully automatic toolpath generation, picking the most suitable tool from those available.

QuickTURN 2D Design

PROFILE DRAWING FEATURES

- Create lines, arcs and threads on external and internal profiles.
- Geometry is limited to the billet size and interacts with the rest of the profile to inhibit the creation of profiles that would be impossible to machine (eg, overhangs or breaking through from the internal profile).
- DXF file import wizard allows designs from other CAD software to be turned into a profile ready for the CAM wizard.
- Profile items can be edited interactively on screen, or by the property editor.
- Profile dimensions update constantly.

TOOLING AND MATERIAL OPTIONS

- The tooling editor allows a wide range of tool types to be edited or created and features a live 3D preview of the tool.
- The shape and size of tool tips and holders can be defined exactly as they are in the real world for a more realistic simulation.
- Tools can be quickly deactivated so the CAM wizard will not pick them.
- Material types can be configured quickly and easily to include feed, speed and cut depth settings for each of the tools available.
- Default feed and speed settings for all tool types can be edited quickly by a unique override slide bar.
- Tooling and material details can be printed out in summary or full detail.

SYSTEM REQUIREMENTS

IBM or 100% Compatible PC,
 Pentium III, 1Ghz, 512MB RAM,
 200MB Free Hard Disk Space,
 Microsoft Windows XP; NT; 2000; Vista;
 Windows 7, 8
 CD-ROM Drive,
 OpenGL 3D Accelerator Graphics Card with
 128MB RAM supporting at least 1024 x 768
 screen resolution.

CNC Machines require USB Connection.

CAM WIZARD FEATURES

Material selector to alter feed, speed and cut depths.

Billet material size editor in case the actual material is larger than the design.

Tooling selector quickly allows certain tools to be deactivated.

Toolpath generator automatically picks the tools and creates all internal/external cutting and threading operations.

Tool nose radius compensation is automatically applied to the generated toolpath for any turning, boring and grooving tools.

A 3D preview of the design also shows the generated toolpaths.

Each set of toolpaths can be deactivated if not required by the rearrange profile editor.

Toolpaths are post-processed to a CNC file suitable for a Denford Lathe.

A fully animated 3D cutting simulation of the tool paths lets you verify that the CNC program is ok.

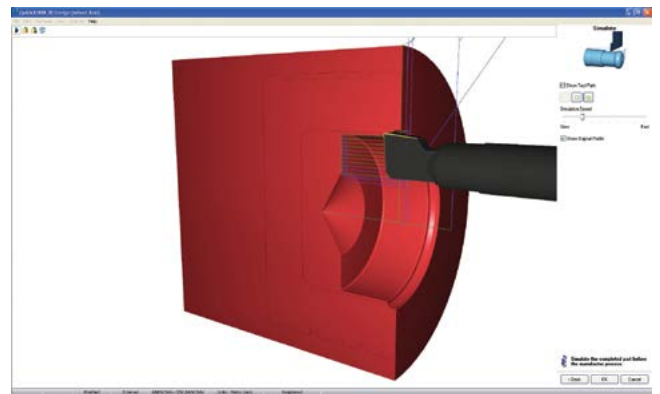

DENFORD

VR CNC Turning

CNC MACHINE CONTROL SOFTWARE

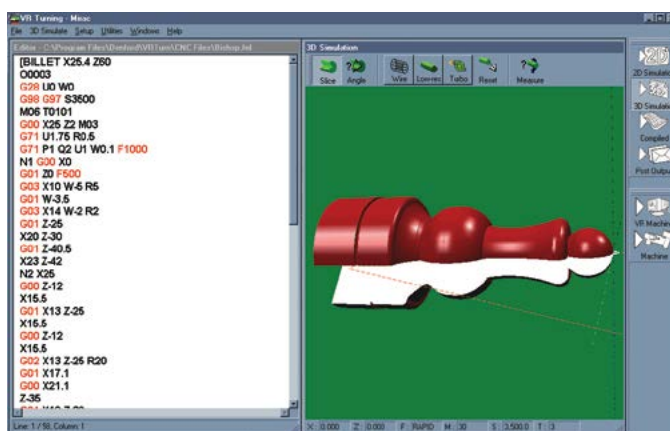
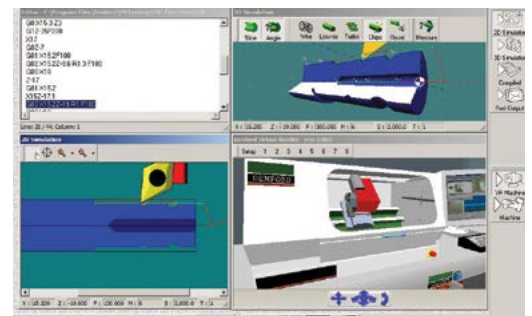
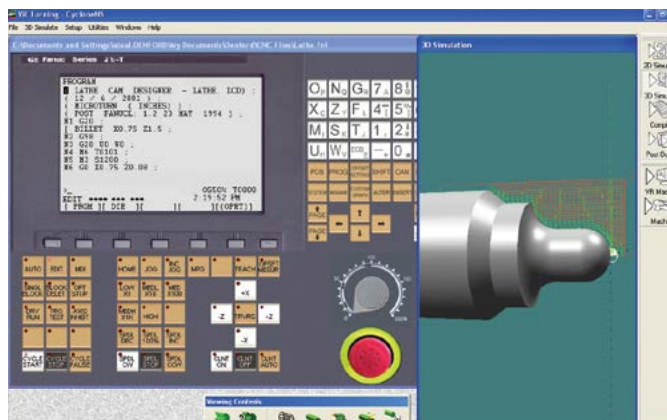
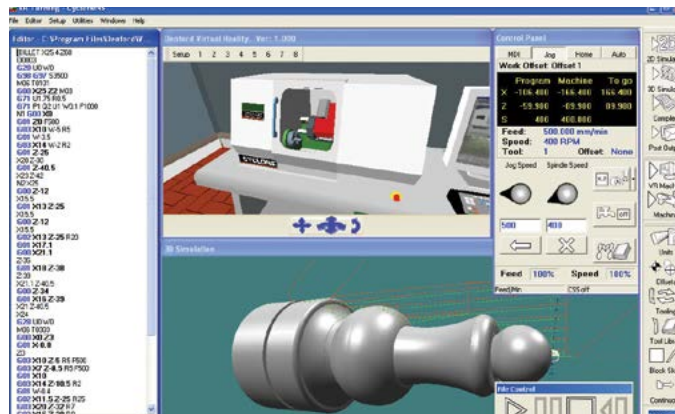

VR CNC Turning is a Virtual Reality based CNC programming software package offering full machine control and Virtual Reality simulation of CNC Lathes. Features include customisable docking toolbars, comprehensive tooling management, colour formatting of NC code & powerful NC code modification options.

VR CNC Turning

PROGRAMMING FEATURES

- Customisable docking toolbars.
- Comprehensive tooling management.
- Colour formatting of NC code.
- Powerful NC Code modification options.
- Context sensitive G&M code help.

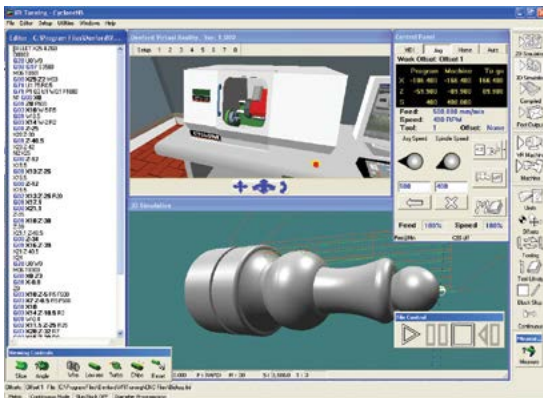

VR SIMULATION FEATURES

- Dynamic rotation/zooming.
- Colour coded move types and tooling.
- Built in Virtual Micrometer to measure the simulated workpiece.
- Unique “SourceTrack” technology for interaction between graphical data and NC Code.



MACHINE CONTROL FEATURES

VR CNC Turning is recommended for physical control of the full range of Denford CNC Lathes. Password protected machine parameters allows tailoring to suit individual machines.

The Denford Post Processor allows translation of NC programs between different controller types.

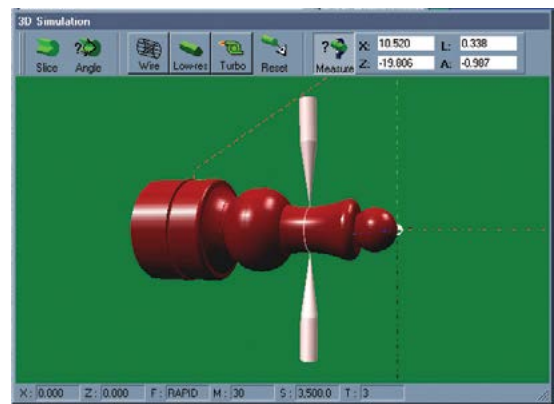

VIRTUAL REALITY FEATURES

Virtual Reality control encourages students to familiarise themselves with machining processes before physical manufacture. Includes a fully working Automatic Turret and library of machine options.

SYSTEM REQUIREMENTS

- IBM or 100% Compatible PC,
- Pentium III, 1Ghz, 512MB RAM,
- 200MB Free Hard Disk Space,
- Microsoft Windows XP; NT; 2000; Vista; Windows 7, 8
- CD-ROM Drive,
- OpenGL 3D Accelerator Graphics Card with 128MB RAM supporting at least 1024 x 768 screen resolution.
- CNC Machines require USB Connection.

DENFORD

Virtual Wind Tunnel

F1 VWT ANALYSIS SOFTWARE

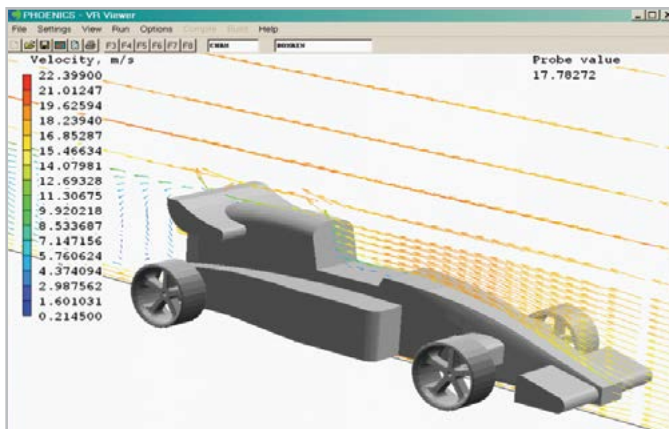
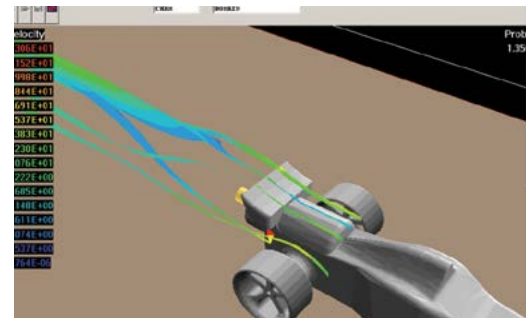
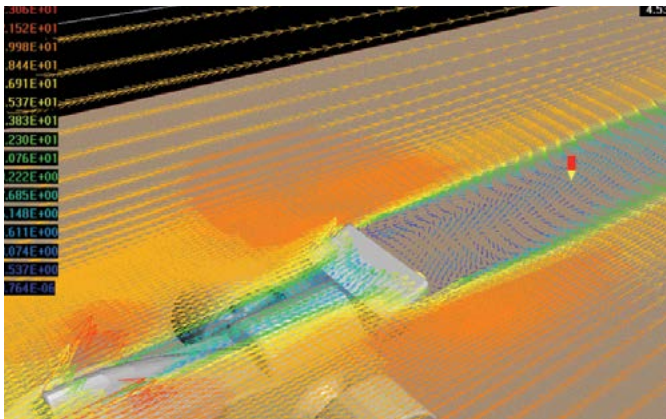
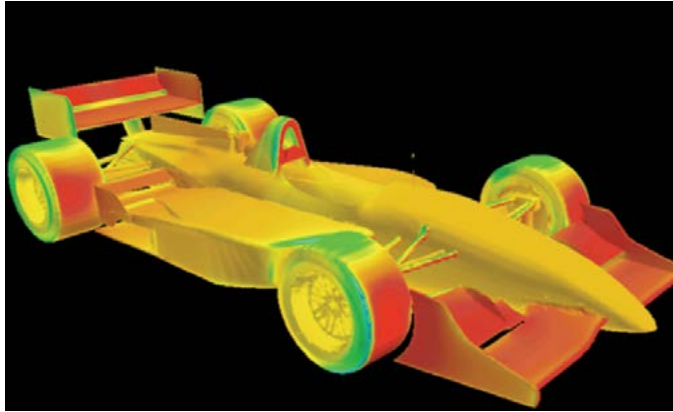

The Virtual Wind Tunnel provides an innovative and cost-effective way for schools and colleges to analyse and test their F1 cars. The results will provide you with information relating to the potential performance of your design, and provide guidance towards the areas for improvement.

Virtual Wind Tunnel

For those involved in the F1 Challenge, the process is simple - students design their F1 car with 3D CAD software such as Autodesk and then export the STL file into the virtual wind tunnel software. The design is then displayed on-screen, allowing students to begin testing the designs for velocities, pressures, areas of turbulence, lift and drag by using vector plots, contour plots, streamlines and isosurfaces.

The Virtual Wind Tunnel Software uses a process called Computational Fluid Dynamics or CFD. This is basically the prediction of processes involving fluid flow, heat and mass transfer, chemical reaction and/or combustion. Anything that involves fluid flow can be simulated using these techniques, with varying degrees of accuracy.

CFD is based upon the laws of physics, of conservation of mass, momentum and energy. The equations are embodied within a mathematical model and solved using a grid superimposed on the region of interest. For the F1 in Schools Challenge, this will be the "Analyse" stage of your team's Design, Analyse, Make, Test and Race process – towards racing success!

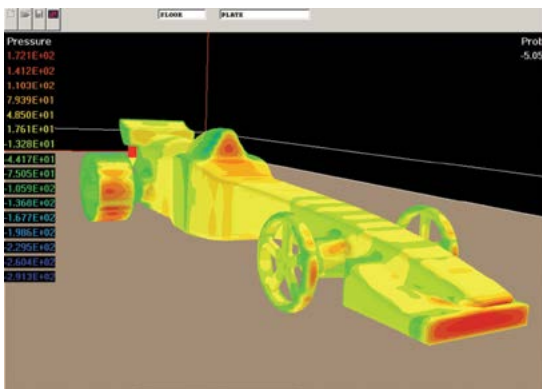

Your design will be imported from CAD software and displayed in our Formula 1 Virtual Wind Tunnel (F1 VWT) software which is already set up to receive it. You will alter initial settings, boundary conditions and other factors in the F1 VWT pre-processor, before starting the mathematical 'solver'. Once the solution has been reached, you will visualise the results interactively in graphical form, using the F1 VWT post-processor.

You will see velocities, pressures, areas of turbulence, lift and drag, using vector plots, contour plots, streamlines and iso-surfaces. The forces on the car body will be calculated and plotted to provide lift and drag data.

Industrial design companies use CFD techniques to assist with their prototype designs. What you do with the information is up to you ...

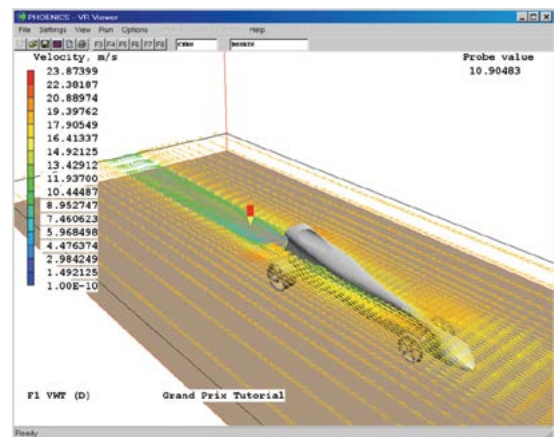

SYSTEM REQUIREMENTS

Any standard Windows PC (XP, VISTA or Windows 7, 8) system. The software is both CPU- and RAM-intensive but 3GB RAM should suffice (& more is better), and a 3GHZ processor speed (as a minimum). No special graphics requirement. Both 32-bit and 64-bit systems are supported but, if required, 64-bit must be specified at time of order.

DENFORD

UP mini 3D Printer

COMPACT 3D DESKTOP PRINTER



Tiertime



Build size: 120 x 120 x 120mm
Print layer thickness: 0.20/0.25/0.30/0.35mm



Spools of UP Branded ABS Filament (1.75mm dia) available in blue, black, white, green, yellow and red.

Spools of UP Branded PLA Filament (1.75mm dia) available in hawaii blue, pompeii grey, rio green and natural.

The UP mini 3D Printer is small in size but big on features. It is simple to use and is ready to produce high quality 3D models from tough ABS plastic within minutes of switching on. The UP mini has a USB interface for simple print spooling and allows you to unplug your computer once it starts printing.

 facebook.com/up3dprinters
 twitter.com/up3dprinters

A selection of these products can be purchased online at



iSupply3D.com
3D Printing
Rapid Prototyping Supplies



Ideal for use in conjunction with



UP mini 3D Printer

The UP mini 3D Printer has many of the features of its big brother the UP Plus 2 3D Printer - the key difference being the model build size.

THE UP MINI 3D PRINTER COMES AS STANDARD WITH:

- UP 3D Printing software
- 1 x Spool White ABS Material
- Perf Board
- Tool Kit & Manual
- 12 Month Warranty

OPTIONAL EQUIPMENT INCLUDES:

- Spools of ABS Material (1.75mm dia) - Available in blue, black, white, green, yellow and red
- Spools of PLA Material (1.75mm dia) - Available in hawaii blue, pompeii grey, rio green and natural
- Perf Board

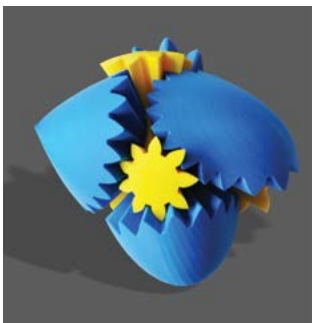
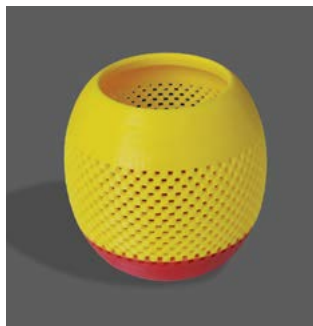
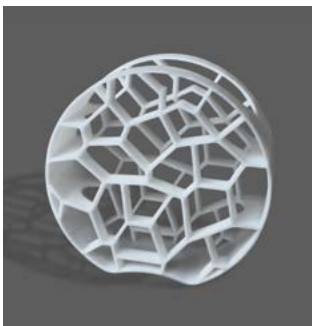

With its robust enclosed steel construction, double linear bearings on each axis, and a temperature stabilizing build chamber, the UP mini ensures consistent build quality throughout the entire print process.

- 'Click and Print Technology' for fast and accurate production of usable 3D models.
- Small footprint – sits perfectly on an office desk.
- Surprisingly large capacity for such a small machine: 120 x 120 x 120mm build size.
- Portable and lightweight – simply carry from room to room.
- Easy to use software – imports .stl files from the vast majority of 3D CAD systems.
- Uses rolls of 1.75mm ABS plastic - provides low running and model making costs.
- 0.20/0.25/0.30/0.35mm layer resolution – for high accuracy 3D model making.
- Enclosed Heat Chamber – consistent build quality throughout the entire print process.
- Robust Steel Construction – ideal for the classroom or home use.
- Smart Breakaway Support – no water soak process is required.

MECHANICAL DETAILS	UP MINI 3D PRINTER
Machine Size	[W] 240 x [D] 340 x [H] 355mm
Machine Weight	6kg
Build Volume/Size	[W] 120 x [D] 120 x [H] 120mm
Material	ABS/PLA
Print Head	Single
Layer Thickness	0.20/0.25/0.30/0.35mm
Power	100-240V - 50-60Hz
Connectivity	USB
Workstation Compatibility	Windows XP, VISTA, 7 & 8, Mac

DENFORD

UP Plus 2 3D Printer

COMPACT 3D DESKTOP PRINTER



Tiertime

NEW

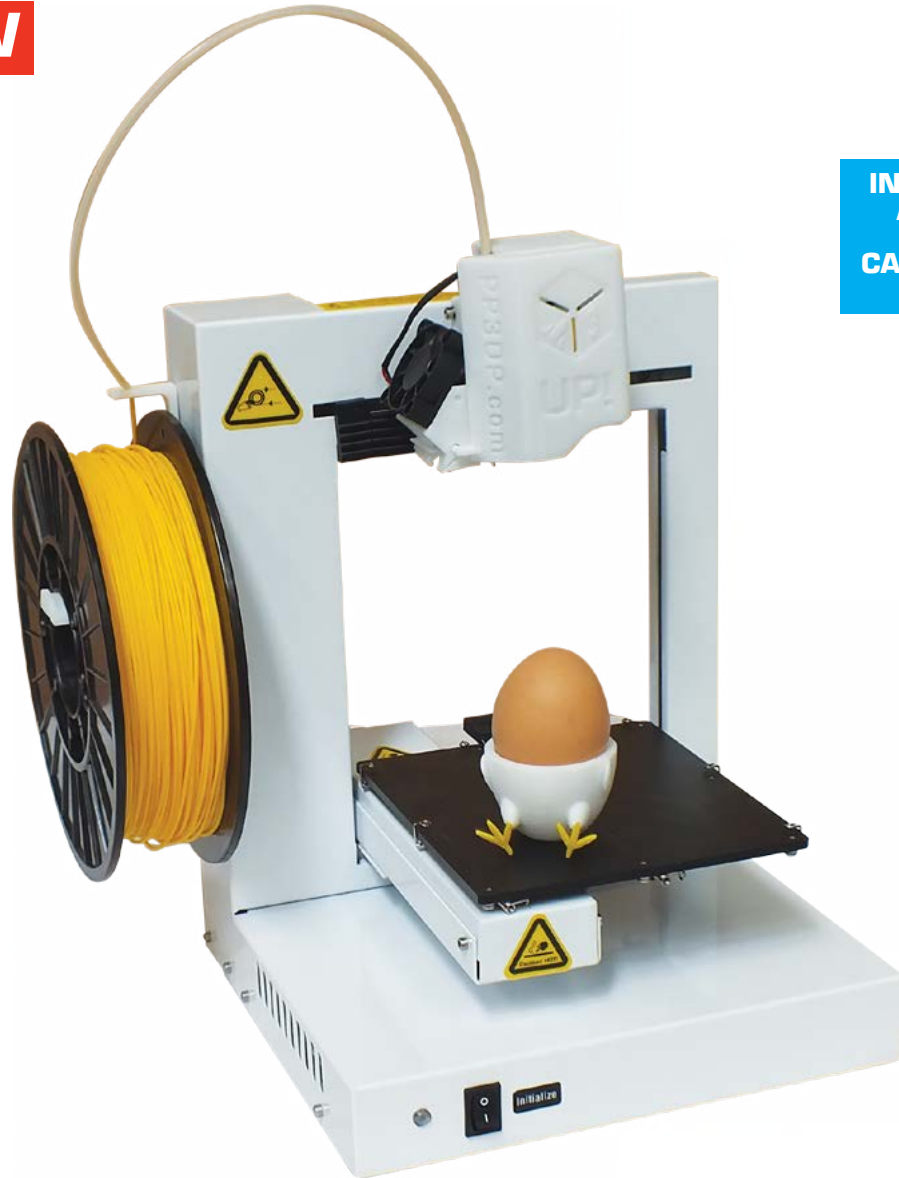

**INCLUDES FULL
AUTOMATIC
PLATFORM
CALIBRATION AS
STANDARD**



Spools of UP Branded ABS Filament (1.75mm dia) available in blue, black, white, green, yellow and red.

Spools of UP Branded PLA Filament (1.75mm dia) available in hawaii blue, pompeii grey, rio green and natural.

The UP Plus 2 is a compact, portable, desktop 3D printer at a truly affordable price. It comes with its own user-friendly software, offering a multitude of user features.

It is the first machine in its class to offer a full automatic platform calibration system as standard including platform levelling and platform height calibration, making the UP Plus 2 simple to use even for the first time user.

 facebook.com/up3dprinters
 twitter.com/up3dprinters

A selection of these products can be purchased online at



iSupply3D.com
3D Printing
Rapid Prototyping Supplies



Ideal for use in conjunction with



UP Plus 2 3D Printer

THE UP PLUS 2 3D PRINTER COMES AS STANDARD WITH:

- UP 3D Printing software
- 1 x Spool White ABS Material
- Perf Board
- Tool Kit & Manual
- 12 Month Warranty

OPTIONAL EQUIPMENT INCLUDES:

- Spools of ABS Material (1.75mm dia) - Available in blue, black, white, green, yellow and red
- Spools of PLA Material (1.75mm dia) - Available in hawaii blue, pompeii grey, rio green and natural
- Perf Board



UP 3D PRINTING SOFTWARE

- Imports STL files from any 3D Design software
- 3D viewing of designs, prior to manufacture
- Model transformation: move, rotate and scale designs
- Automatic and manual model placement
- Automatic support and slice generation
- One touch printing

DESKTOP FRIENDLY

The UP Plus 2 is quiet and clean; and with a small footprint, will not clutter your workspace. Yet for such a compact machine, the UP Plus 2 3D Printer has an impressively-sized working envelope of 140 x 140 x 135mm, to allow for manufacture of an extensive range of 3D models, using low-cost ABS and PLA material.



MECHANICAL DETAILS	UP Plus 2 3D PRINTER
Machine Size	[W] 245 x [D] 260 x [H] 350mm
Machine Weight	5kg
Build Volume/Size	[W] 140 x [D] 140 x [H] 135mm
Material	ABS/PLA
Print Head	Single
Layer Thickness	0.15 / 0.20 / 0.25 / 0.30 / 0.35 / 0.40mm
Power	110-240V - 50-60Hz
Connectivity	USB
Workstation Compatibility	Windows XP, VISTA, 7 & 8, Mac

DENFORD

UP BOX

COMPACT 3D DESKTOP PRINTER

NEW



Tiertime

**INCLUDES FULL
AUTOMATIC
PLATFORM
CALIBRATION AS
STANDARD**



NEW 500 grams Spools of ABS & PLA



Spools of UP Branded ABS Filament (1.75mm dia) available in blue, black, white, green, yellow and red.

Spools of UP Branded PLA Filament (1.75mm dia) available in hawaii blue, pompeii grey, rio green and natural.

The UP BOX is the new feature-rich desktop 3D Printer from Tiertime. Ideal for both professional and educational users alike, the UP BOX is the third, ground-breaking model in the award-winning UP Series of desktop 3D Printers. Incorporating proven UP features, as already included in the UP mini and UP Plus 2 Printers, the new UP BOX is easy to use and boasts an impressive build size of 255 x 205 x 205mm and 100 micron layer thickness / resolution, to provide high quality, high definition models at the touch of a button.

A selection of these products can be purchased online at



iSupply3D.com
3D Printing
Rapid Prototyping Supplies



Ideal for use in conjunction with



facebook.com/up3dprinters

twitter.com/up3dprinters

UP BOX 3D Printer

THE UP BOX 3D PRINTER COMES AS STANDARD WITH:

- UP 3D Printing software
- 1 x 500g Spool White ABS Material
- Tool Kit & Manual
- 12 Month Warranty

OPTIONAL EQUIPMENT INCLUDES:

- 500g Spools of ABS Material (1.75mm dia) - Available in blue, black, white, green, yellow and red
- 500g Spools of PLA Material (1.75mm dia) - Available in hawaii blue, pompeii grey, rio green and natural

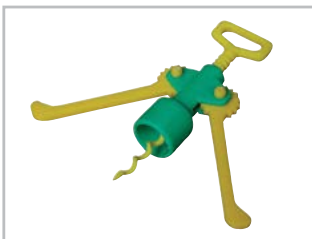

- **Fully Automatic Platform Calibration:** Automatic platform levelling and nozzle height detection with integrated probe, providing a seamless 3D printing experience.
- **Large Build Volume:** Impressive build volume of W255 x D205 x H205mm for extra large print jobs.
- **Faster Printing with Higher Precision**
With the same print quality, the UP BOX prints 30% faster than UP Plus 2, with 100 micron layer thickness.
- **Enclosed Printing Environment with New ABS Print Surface**
The enclosed build chamber maximizes temperature stability and this combined with an ABS print surface to enhance adhesion results in minimum warping for printing large objects.
- **Smart Support Technology**
This advanced technology automatically produces easily removable support structures and allows difficult and complex designs to be printed with ease.
- **Powerful but Easy to use Software**
The UP Software is simple to use and feature rich - it's simple enough for first time users and versatile enough for experts!
- **Quiet Operation and Air Filtration:** The UP BOX produces very little noise; and has a built-in air filter to absorb fumes and minimize odour.

MECHANICAL DETAILS	UP BOX 3D PRINTER
Machine Size	[W] 485 x [D] 495 x [H] 520mm
Machine Weight	20kg
Build Volume/Size	[W] 255 x [D] 205 x [H] 205mm
Material	ABS/PLA
Print Head	Single
Layer Thickness	0.10 / 0.15 / 0.20 / 0.25 / 0.30 / 0.35 / 0.40mm
Power	110-240V - 50-60Hz
Connectivity	USB
Workstation Compatibility	Windows XP, VISTA, 7 & 8, Mac

TierTime Rapid Prototyping

AFFORDABLE, QUALITY 3D PRINTERS



Inspire S200 / S250

FOUR MODELS AVAILABLE



Inspire D255 / D290

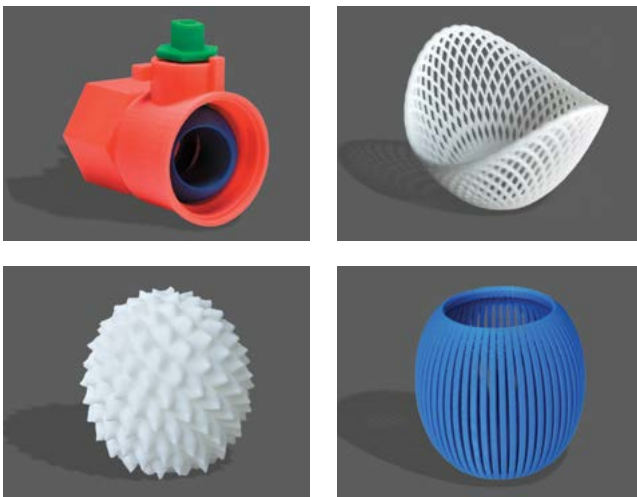

Low cost ABS Filament, available in blue, black, white, green, yellow and red.

TierTime machines are supplied complete with user-friendly software and absolutely everything required to get you up and running with the minimum of fuss. There is no training required - the machines come with set-up instructions and a detailed user manual. Simply use the TierTime Printer to convert your 3D designs (.stl files) into durable, working ABS plastic models - literally at the touch of a button!

Rapid Prototyping

TierTime Technology Co. Ltd. was founded in 2003, and since then has become one of the fastest growing providers of Rapid Prototyping and 3D Printing machines.

INSPIRE S200 & INSPIRE S250

The **Inspire S200** is an affordable entry level printer which provides low cost, high quality, durable ABS 3D models whenever and wherever you need them.

The **Inspire S250** is capable of printing larger parts than the Inspire S200. Both models run quietly and do not need to be attended.

The production of ABS models is a "clean" process, which does not create fumes or toxic materials which would necessitate special handling/ventilation. The Inspire S250 is suitable for an office environment, and the build envelope is 150 x 200 x 250mm – ideal for educational establishments, industrial design studios, medical organisations. etc.

INSPIRE D255 & INSPIRE D290

The **Inspire D255** is TierTime's mid-range Rapid Prototyping machine, printing high resolution models quickly and effectively and providing a high level of detail and accuracy. It is possible to actually snap or fit together the ABS parts to help you to identify design mistakes while they are still relatively easy to fix.

The **Inspire D290** is the flagship model of the TierTime range and prints larger models than its sister product, the Inspire D255. The machine offers high quality ABS models which won't warp or shrink and are tough enough to be used as working parts, able to withstand rigorous testing procedures.

Build Material: ABS B501

Support Material: ABS S301

TierTime Rapid Prototyping machines are used on a daily basis in schools, universities, and manufacturing companies around the world, as well as a number of blue chip companies such as Proctor & Gamble.

TierTime machines use low cost / high quality reels of ABS Material, which are available in a variety of colours such as blue, red, black and white and are perfect for use in both education and industry – for example in engineering, architectural, medical and aeronautical applications.

TierTime machines import .STL files from the majority of 3D Design software packages, such as SolidWorks, Autodesk Inventor and Pro/DESKTOP. They offer a host of technical features linked to high-speed production of high-resolution, robust ABS models, which will not shrink or warp (layer thickness - dependent on model of printer: 0.20/0.25/0.30/0.35/0.40mm). TierTime Inspire machines offer a range of working envelopes - up to 255 x 290 x 320mm - for manufacture of an extensive range of 3D models.

All TierTime machines comply with all European Health and Safety standards and are CE certified.

SYSTEM REQUIREMENTS

Windows 7,8, Vista & XP

MECHANICAL DETAILS	Inspire S200	Inspire S250	Inspire D255	Inspire D290
Build Envelope:	150 x 200 x 200mm	150 x 200 x 250mm	255 x 255 x 310mm	255 x 290 x 320mm
Layer Thickness:				
Single Nozzle	0.15mm	0.15mm	0.15mm	0.10mm
Double Nozzle	0.20/0.25/ 0.30/0.35mm	0.20/0.25/ 0.30/0.35mm	0.175/0.20/0.25/ 0.30/0.35/0.40mm	0.15/0.175/0.20/0.25/ 0.30/0.35/0.40mm
Build Speed:	5-60cm ³ /hr	5-60cm ³ /hr	5-60cm ³ /hr	5-60cm ³ /hr
Jetting Head:	Single/Double nozzle	Single/Double nozzle	Single/Double nozzle	Single/Double nozzle
Size:	630 x 660 x 960mm	760 x 730 x 1200mm	720 x 850 x 1650mm	720 x 850 x 1650mm
Weight:	65kg	150kg	170kg	170kg
Software:	TierTime Model Wizard	TierTime Model Wizard	TierTime Model Wizard	TierTime Model Wizard
Power:	220-240V, 1.5KW	220-240V, 1.5KW	220-240V, 1.5KW	220-240V, 2.0KW

DENFORD

VLS Series Lasers

LASER CUTTERS & ENGRAVERS



VLS Series safety features include Over Temperature Sensor with Audible Alarm, Safety Glass, Automatic Recognition of Accessories and 'Smart Technology' ULR Laser Cartridges which can be easily changed by the user. VLS Series Laser Systems are RoHS Compliant.

EXCLUSIVE

Advantage Integrated Fume Extraction Cart with on-board Air Assist Compressor

For LaserCAM 2D Design Software
see pages 38 - 39



Side panel colour variations

VLS Series Lasers can transform images or drawings on your computer screen into real items made from a wide variety of materials. These Lasers are ideal for cutting, deep engraving, precision scribing, decorative etching on wood, plastic, fabric, leather, paper, rubber and will also mark glass, ceramic, metal and stone.



VLS Series Lasers

There are two bed sizes to choose from and 5 power options available to accommodate a variety of budgets and applications. The VLS Series' access door and side panels come in a variety of colours including red, green, blue, yellow or purple.

Optional equipment includes a Honeycomb Bed, Integrated Fume Extraction Cart with built in Air Assist Compressor, Rotary Fixture and High Density Focusing Optics. An Air Assist Back Sweep is available for use when cutting rubber.

VLS Series Lasers have a unique 'materials cutting' menu so there is no need to look-up power and speed settings - simply select the type of materials and thickness to be lasered and press the start button. Design and Print, it's as simple as that!

VLS Series Lasers are recommended for use with Denford's Advantage Integrated Fume Extraction Cart with built in Air Assist Compressor, Pre Filter and HEPA Chemical Gas Filter, which can be visually monitored by a 3 stage Filter Status Display. The unit is portable and will pass through a standard width doorway.

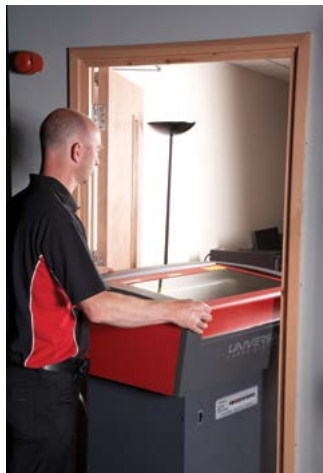

SYSTEM REQUIREMENTS

Microsoft Windows, XP, 2000, Vista, 7 & 8.
USB 2.0 Connection.

ROTARY FIXTURE - OPTIONAL

The Rotary Fixture permits laser processing around cylindrical surfaces up to a maximum 127mm (5.0") diameter. A sensor detects when the fixture is installed and adjusts automatically.

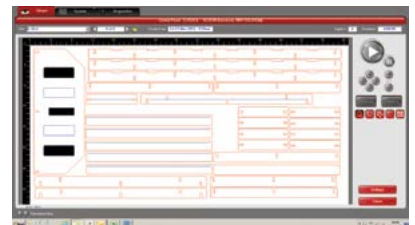

MACHINE DETAILS	VLS2.30	VLS3.50	ADVANTAGE UNIT
Machine Length	661mm	864mm	670mm
Machine Depth	635mm	635mm	470mm
Machine Height	356mm	356mm	770mm
Machine Height on Advantage Unit	1118mm	1118mm	N/A
Machine Weight	32kg	43kg	65kg
Approx. Working Area	305 x 406mm	305 x 610mm	N/A
Watts of Laser Power	10, 25 or 30	10, 25, 30, 40 or 50	N/A
Volts	230 Volts	230 Volts	230 Volts
Amps	10 Amps	13 Amps	7.25 Amps
Electrical Connection	13A Socket	13A Socket	13A Socket

SAFETY INFORMATION

Class I safety enclosure for CO2 laser beam. Class IIIa for red laser pointer.

DENFORD

Large Format VLS Series Lasers

LASER CUTTERS & ENGRAVERS



VLS Series safety features include Over Temperature Sensor with Audible Alarm, Safety Glass, Automatic Recognition of Accessories and 'Smart Technology' ULR Laser Cartridges which can be easily changed by the user. VLS Series Laser Systems are RoHS Compliant.

For LaserCAM 2D Design Software
see pages 38 - 39



Side panel colour variations

Large Format VLS Series Lasers are free standing laser units with a large working area. There are numerous models and power options available to accommodate a wide range of budgets and applications including cutting, deep engraving, precision scribing, decorative etching on wood plastic, fabric, leather, paper, rubber and also the marking of glass, ceramic, metal and stone.



Large Format VLS Series Lasers

Optional equipment includes a Honeycomb Bed, Fume Extraction Cart with built in Air Assist Compressor, Rotary Fixture and High Density Focusing Optics. An optional Air Assist Back Sweep is available for use when cutting rubber.

VLS Series Lasers have a unique 'materials cutting' menu so there is no need to look-up power and speed settings - simply select the type of materials and thickness to be lasered and press the start button. Design and Print, it's as simple as that!

Large Format VLS Series Lasers are recommended for use with Denford's AD-ORACLE Extraction Cart with built in Air Assist Compressor, Pre Filter and HEPA Chemical Gas Filter which can be visually monitored by a Filter Status Display.

SYSTEM REQUIREMENTS

Microsoft Windows, XP, 2000, Vista, 7 & 8.
USB 2.0 Connection.

ROTARY FIXTURE - OPTIONAL

Permits laser processing around cylindrical surfaces up to 203mm (8.0") diameter and up to 406mm long.



AD-ORACLE
Extraction Unit



Automatic Driver



Manual Driver

MACHINE DETAILS	VLS3.60	VLS4.60	VLS6.60	AD-ORACLE Extraction Unit
Machine Length	914mm	914mm	1118mm	430mm
Machine Depth	762mm	914mm	914mm	430mm
Machine Height	965mm	965mm	991mm	980mm
Machine Weight	107kg	122kg	147kg	90kg
Approx. Working Area	305 x 610mm	457 x 610mm	457 x 813mm	N/A
Watts of Laser Power	10, 25, 30, 40, 50, 60	10, 25, 30, 40, 50, 60	10, 25, 30, 40, 50, 60	N/A
Volts	230 Volts	230 Volts	230 Volts	100 - 240 Volts
Amps	10 Amps	10 Amps	10 Amps	12.5 Amps
Exhaust Connections Dia.	101.6mm	101.6mm	2 x 101.6mm	75mm
Electrical Connection	13A Socket	13A Socket	13A Socket	13A Socket

SAFETY INFORMATION

Class I safety enclosure for CO2 laser beam. Class IIIa for red laser pointer.

F1 in Schools Package

A COMPLETE PACKAGE INCORPORATING DESIGN, ANALYSE, MAKE, TEST & RACE

The F1 in Schools Technology Challenge stimulates a student's interest in, and understanding of the entire process of design and manufacture. Through involvement in the F1 in Schools Challenge, students will gain first hand experience of teamwork and communication, whilst encouraging individual flair and confidence. The F1 in Schools Challenge provides students with the opportunity to reflect industrial working practice of developing a product from concept, to prototype to production.

Plan

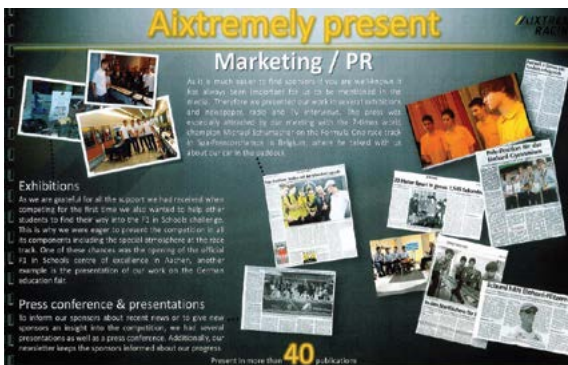

Design

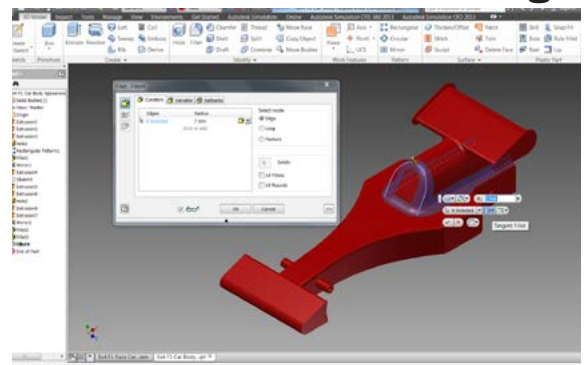

Analyse

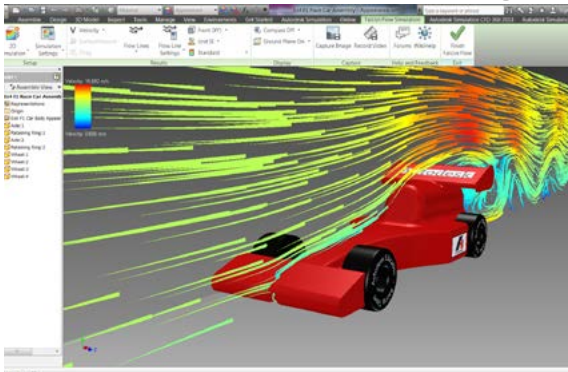

Make



Test



Race

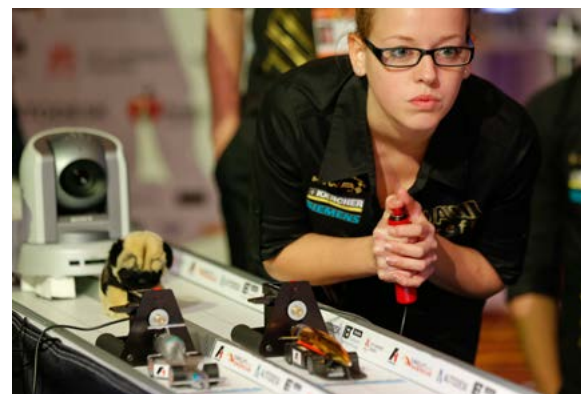

f1inschools.com



Ideal for use in conjunction with



F1 in Schools Package

In support of the F1 in Schools Technology Challenge, Denford offer an F1® Package, which includes all of the equipment required to get you up and running for this innovative educational project - covering Design, Analyse, Make, Test & Race.

A brief overview:

1. Plan: Prepare a **business plan**, develop a budget and raise sponsorship. Teams are encouraged to collaborate with industry and create business links.

2. Design: Using 3D CAD [Computer Aided Design] software, **design** an F1® car of the future to the specifications set by the International Rules Committee just like in Formula 1®.

3. Analyse: Aerodynamics are **analysed** for drag coefficient in a virtual wind tunnel using Computational Fluid Dynamics Software [CFD].

4. Make: Using 3D CAM [Computer Aided Manufacture] software, the team evaluates the most efficient machining strategy to **make** the car.

5. Test: Aerodynamics are **tested** in wind and smoke tunnels.

6. Race: Time to test what your team has worked so hard together to achieve: **a winning car**.

The F1 in Schools Package:

DESIGN:

Autodesk® 3D Design, Drafting & Simulation Software
QuickCAM Pro Advanced Milling/Routing CAM software (site licence).

ANALYSE:

Virtual Wind Tunnel (VWT) Software (single licence).

MAKE:

CNC Machine Options

- Router 2600/Router 2600 Pro (Metal Cutting).
- Compact 1000 Pro (Metal Cutting).
- MRC 40

Car Manufacture Fixture

F1 in Schools Car Manufacturing Fixture for both Bloodhound SSC & Formula 1® Class cars.

Consumables - Bloodhound SSC & Formula 1® Class Cars

- Formula 1® Class Balsa Wood Blanks - Pack of 20.
- Fusion Wheels - Black - Pack of 100.
- Screw Eyes 1" - Pack of 100.
- Long Axles - 65mm - Pack of 100.
- Straw Wheel Spacers - Pack of 500.
- Washers - 4mm - Pack of 100.
- Decal Stickers - Pack of 25 sheets.
- Paint Stand.
- Bloodhound SSC Class Balsa Wood Blanks - Pack of 20.
- PX Wheels - Rear - Black - Pack of 100.
- LX Wheels - Front - Black - Pack of 100.
- Screw Eyes 1/4" - Pack of 100.
- Short Axles - 43mm - Pack of 100.

TEST:

Scout Wind Tunnel.
Fog Maestro Smoke Generator including 1Ltr. Fog Fluid.

RACE:

Elevated Race Track - 25m track.
F1 Race System [x1 Start & Finish Gate, x2 Launch Triggers, x2 Launchers, x1 Power Supply, x1 Control Box].
8 Gram Competition Cartridges [pack of 120].



Compact 1000 PRO

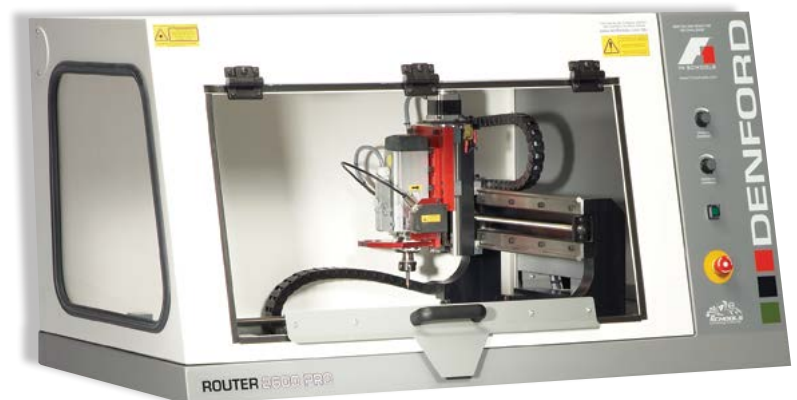

Router 2600 PRO

For the full range of F1 consumables & race equipment see pages 72 - 77.



3D Scanning & Manufacturing

COMPLETE 3D LASER SCANNING AND MANUFACTURING PACKAGE

A complete 3D Scanning and Manufacturing Package which includes hardware and user friendly wizard based software for scanning, editing and saving of 3D models, prior to manufacture on a Denford CNC Router.

Ideal for Reverse Engineering Applications.

Scan

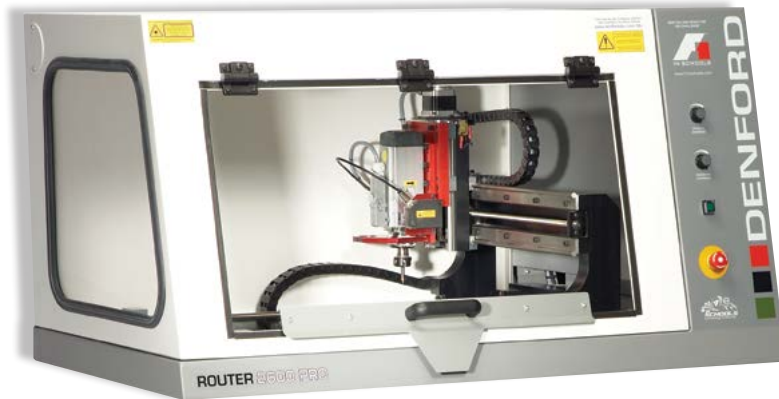

Edit



Make

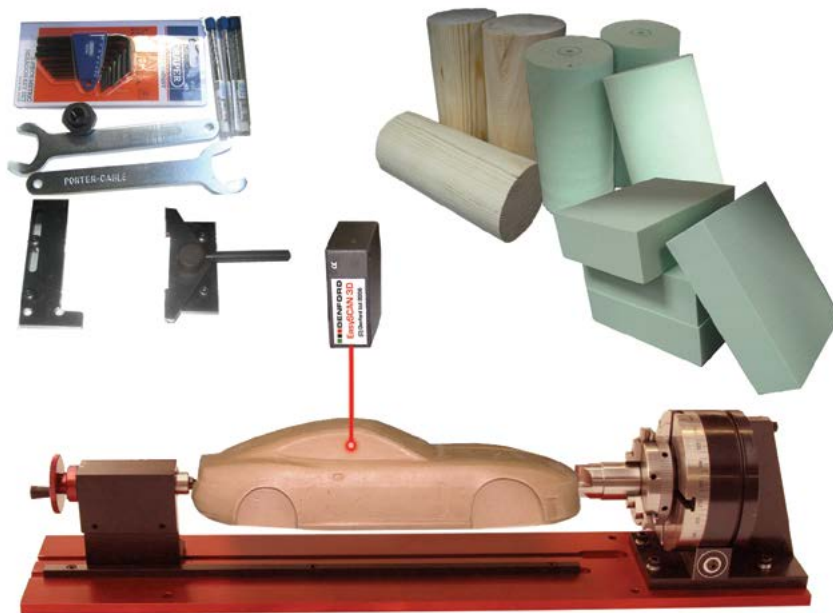

3D Scanning & Manufacture

Denford's EasySCAN 3D Laser Scanning and Manufacturing Package comes with everything you need to laser scan and digitise objects in 3 dimensions, directly into your PC and then manufacture on one of Denford's CNC Routers.

It is an easy to use, cost effective solution for reverse engineering applications, which gives fantastic results every time....

The EasySCAN 3D Laser Scanning and Manufacturing Package incorporates user-friendly wizard based software for scanning, editing and saving of 3D models, prior to manufacture on a Denford CNC Router. The EasySCAN 3D Laser Scanner attachment has full 360-degree scanning capability when used in conjunction with the supplied 4th Axis Programmable Rotary Fixture.

Denford's EasySCAN 3D Laser Scanning and Manufacturing Package includes:

Wizard Based Software for scanning, editing and saving 3D models before manufacture.

CNC Machine Options

- Router 2600 Pro (Metal Cutting)
- Router 2600
- Compact 1000 Pro (Metal Cutting)
- MRC 40

4th Axis Programmable Rotary Fixture including QuickCAM 4D Milling CAM Software.

Tooling for use with a range of resistant materials including hardwood, softwood, plastic, modelling foam, acrylic and prototyping materials.

A set of work holding clamps.

Consumables package including:

- 50 Round Pine Billets (65mm dia x 150mm long)
- 50 High Density Foam Billets (70mm dia x 150mm long)
- 50 High Density Foam Billets (150 x 110 x 45mm)

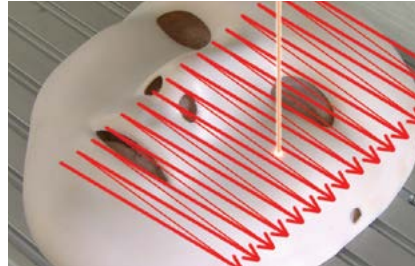

Scan in your chosen model (or create your own)

View results with the EasySCAN software

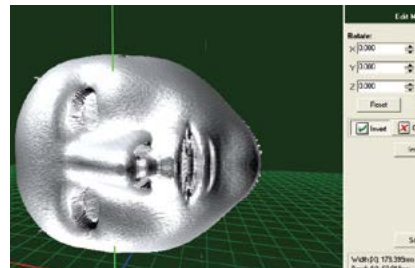
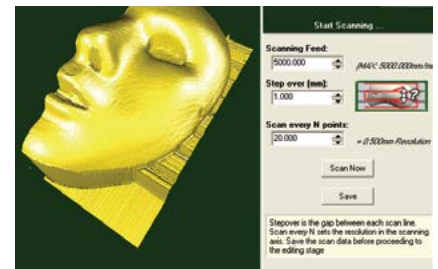

Manipulate the scanned data

Manufacture on the CNC Router



The completed model

DENFORD

3D HD Scanning

AFFORDABLE, EASY TO OPERATE 3D SCANNING



NextEngine uses 4 lasers for high scanning speeds and cleaner scan data. The scanner measures 50,000 points per second to create highly detailed digital models that can be exported on .stl, .obj and .vrmf amongst other file formats. There are no scan limits, as larger scans can easily be meshed together.

Optional software allows scanned models to be saved in CAD format for editing in 3D CAD packages such as SolidWorks.



Scan Object



Mesh File



Machine Part

NextEngine 3D Scan Solutions

In one package, everything you need to quickly scan and digitise physical objects

Schools have discovered the hands-on learning power of classroom Rapid Prototyping, with 3D input and output linked to CAD and computer generated imaging (CGI) systems. 3D Printing lets students quickly create physical models, and 3D Scanning lets them digitize reference samples and revisions to their 3D prints. Get full scanning and modelling with a low-cost NextEngine HD Scanner.

NEXTENGINE 3D HD SCANNER INCLUDES:

PRODUCT CODE



Desktop 3D Scanner

Multi-laser precision provides 127-micron measuring accuracy and texture capture for creation of highly detailed, full-colour 3D models.

NXHDS



Automated Positioner

Enables one-button alignment of multiple scans to speed 3D model creation.



SCANSTUDIO HD™

Scan Control Software

Points to MESH. Essential tools to scan, align, fuse and polish scan data for creation of fully healed mesh models ready for 3D printing or for output to CGI or CAD modelling software.

OPTIONAL:

PRODUCT CODE



SCANSTUDIO CAD TOOLS™

NXSCAD

Transforms scans into surfaces for CAD modelling. Convert scan data meshes into NURBS and transfer to CAD. Automatically section scans and output NURBS splines to CAD. Specify part top, bottom, sides, and origin before surfacing. One-button automatic surface creation through fishnet drape.



RAPID Works™

NXRPW

Brings smart physical modelling power to CAD platforms. Full-featured solution to make CAD parts from scan points. Outputs IGES, STEP, and SLDPRT for transfer to CAD systems. Full RapidformXOR2 features. The most advanced in the world. Automated feature extractor reduces drafting labour up to 90%. Fully parametric model with true SolidWorks Feature Tree output.

SYSTEM REQUIREMENTS

Windows XP, Vista 7 & 8, 64-Bit, 2.5 Ghz Dual-core, 4GB RAM, 512MB Graphics, Powered USB 2.0 Hub

F1 Curriculum Resource

CROSS-CURRICULAR RESOURCES FOR KEY SUBJECTS

Offer Students the Chance to Become World Champions!

RUN A CROSS-CURRICULAR PROJECT BASED ON A GLOBAL COMPETITION

GAIN READY-TO-USE RESOURCES FOR KEY CURRICULUM SUBJECTS

GET INVOLVED IN A HUGE SPORTING PHENOMENON

SUPPORT HARD-PRESSED STAFF

USE ACROSS THE SCHOOL AND COLLEGE, IN A RANGE OF SUBJECTS

The F1 in Schools Curriculum Resources present the opportunity for your School or College to:

- bring learning to life.
- motivate students.
- set up cross-curricular learning easily and quickly
- reward your students at a regional, national and international level.

Benefit the whole School/College

The F1 in Schools Resources can help your School / College to:

- improve motivation - the engaging nature of the activities and the glamorous topic makes students want to learn.
- raise achievement - the element of competition makes students want to do well.
- encourage independent learning - the open-ended nature of the project enables young people's talent to flourish - whatever their interests.
- involve students of all ages and abilities - the resource helps to embed the competition across the School /College.



 **THE FORMULA ONE™ TECHNOLOGY CHALLENGE**
IN SCHOOLS

What is F1 in Schools?

F1 in Schools, the Formula 1® (F1) Challenge, is a multi-disciplinary contest involving over 40 countries. Students plan, design, manufacture, test and then race miniature balsa wood racing cars powered by compressed gas.

For more information, visit f1inschools.com

Recognised by the DfE as an effective tool for raising achievement

F1 Curriculum Resource

Gain a huge range of materials

Fully referenced to the National Curriculum (including enterprise education) and relevant GCSE specifications, the F1 in Schools Curriculum Resources include materials for students 11-19.

Support cross-curricular learning

Colleges and schools are used to setting up project-based or enquiry-based learning. However, the F1 in Schools Curriculum Resource makes it easy, presenting a fully supported, tried and tested project, which is ready to use.

11-14 Bloodhound SSC Class & 11-14 F1 Class

- Both these editions cover 9 subjects: English, Maths, Science, ICT, Design and Technology, Enterprise Education, Art and Design, PE and Citizenship.
- The Bloodhound SSC edition has 58 lesson plans, and the F1® Class 11-14 edition has 60 lesson plans. Both have enough for 14 days of lessons in total.
- Delivery is flexible. The lesson plans are designed to be adapted to teachers' requirements. Sessions can be timetabled in place of some normal lessons over the course of a term, or on a fortnightly cross-curricular day set aside for the purpose.
- Full instructions are given on running an in-school F1 in Schools challenge, providing an exciting climax to the project.
- There is extensive guidance on how to run the project, including timetabling, promoting it in school, and linking the sessions to students' regular work.

14-19 F1 Class

The 14-19 edition contains over 60 lesson plans based around the different parts of the F1 in Schools challenge. This content is mapped to relevant exam specifications, so that F1 in Schools work can be integrated with students' work towards real qualifications, including coursework and extended projects. Delivery is very flexible, and the proportions of taught lessons and independent learning can be varied to suit the school's requirements.

Each resource contains detailed session plans, clear learning objectives, high quality resources and extensive guidance on managing, implementing and assessing the project, helping you to:

- set up the project to suit your establishment
- provide differentiated activities
- assess students' work
- monitor students' progress.

All available online, each year

Each F1 in Schools Curriculum Resource is accessed online and is sold with a full site licence for use in your School / College for the subscription period (12 months). The licence enables you to share and copy the materials throughout your School / College. A wealth of editable digital files is included which can be viewed on screen or printed on demand.

Available in three editions:

- 11-14 Bloodhound SSC Class
- 11-14 F1® Class
- 14-19 F1® Class

To view a demo, visit: www.fscr.pearson.co.uk/ and enter one of the following:

11-14 Bloodhound SSC Class

user name: demo password: password

11-14 F1® Class

user name: demo1114 password: password

14-19 F1® Class

user name: demo1419 password: password



F1 Consumables

F1 IN SCHOOLS EQUIPMENT & CONSUMABLES

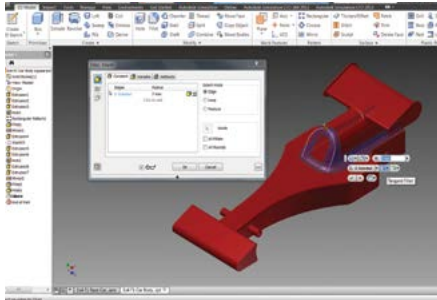

DESIGN

3D Design Software AUTODESK

Design your car using Autodesk® 3D Design Software. Autodesk and F1 in Schools™ partnered to offer design tools to help prepare next-generation designers. Students and schools participating in F1 in Schools™ can access an extensive portfolio of Autodesk® 3D design software free of charge. To get your software please visit: www.f1inschools.com/autodesk

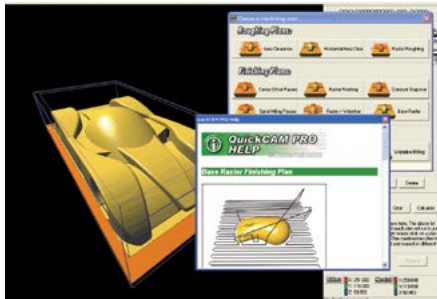

QuickCAM Pro

An advanced, yet simple to use, wizard-based CAM package, which is used to create cutter paths for machining 3D parts on a milling machine or router.

Site Licence

BIO1806P



ANALYSE

Virtual Wind Tunnel

F1 VWT Analysis Software

Single Seat

5 User Licence

Site Licence

BIO1841

BIO1841A

BIO1841C



MAKE

CNC Machine Options for F1 Car Manufacture:

MRC 40

Compact 1000 Pro (Metal Cutting)

Router 2600

Router 2600 Pro (Metal Cutting)

Router 6600

Router 6600 Pro (Metal Cutting)

MRC004000

MRC003000

MRP002000

MRP003000

MRF002000

MRF003000



F1 in Schools Car Fixture

Comes as standard with two clamping systems to enable the manufacture of Bloodhound SSC & Formula 1® Class cars. The fixture clamps directly to the T-slotted table on the MRC 40 (T-slotted table not standard equipment with MRC 40), Compact 1000 Pro and Router 2600/Pro and is also suitable for use on the VMC 1300 (it is necessary to remove the tool changer to fit the fixture)

NR1/0400UA

Formula 1® Class Car Kit: Fusion

Includes set of 4 x black Fusion wheels, 1 x sandpaper, 2 x screw eyes, 2 x axles, straw wheel spacers, 4 x washers, 1 x Formula One Class balsa wood blank.

N13226F1R01

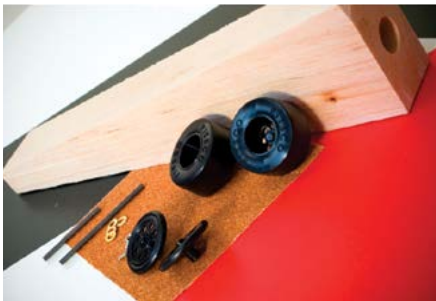
Bloodhound SSC Class Car Kit: PX & LX Wheels

Includes 2 x PX rear wheels and 2 x LX front wheels, 1 x sandpaper, 2 x screw eyes, 2 x axles, straw wheel spacers, 4 x washers, 1 x Bloodhound SSC Class balsa wood blank.

N13226DE1

Formula 1® Class Wheels

Set of Fusion Wheels - Black (pack of 4)
 Set of Fusion Aluminium Effect Hubs (pack of 4)
 Fusion Wheels - Black (pack of 100)
 Fusion Aluminium Effect Hubs (pack of 100)

 N54531/OSET
 N54608/OSET
 N54531
 N54608

Bloodhound SSC Class Wheels

Set of PX and LX Wheels - 2 Front, 2 Rear - Black
 PX Wheels - Rear - Black (pack of 100)
 LX Wheels - Front - Black (pack of 100)

 N21899/OSET
 N30848
 N30846

Formula 1® Class Wheel Kit

includes:
 4x Wheels,
 2x Tether Line Guides,
 4x Axle Inserts/Grommets (6mm)
 2x Axles

N14759

F1 Consumables

F1 IN SCHOOLS EQUIPMENT & CONSUMABLES



MAKE

NEW F1® Model Block (pack of 10)

This official F1® Model Block measures 223mm x 65mm x 50mm, with a consistent weight of 112 grams and contains a pre-drilled hole for the CO2 cartridge.

F1223/10



Formula 1® Class Balsa Wood Blank (pack of 10)

This official Formula 1® Class balsa wood blank measures 223mm x 65mm x 50mm and contains a pre-drilled hole for the CO2 cartridge.

N28886/10



Bloodhound SSC Class Balsa Wood Blank (pack of 10)

Blank measures 304mm x 41mm x 70mm and contains a pre-drilled hole for the CO2 cartridge.

N53347

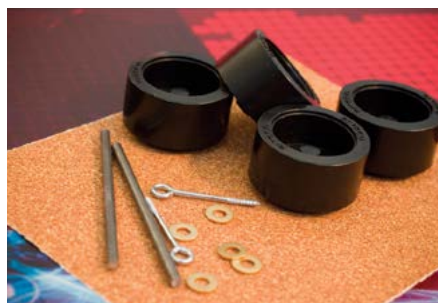

Formula 1® Class Kit Bag (for one car, excluding balsa blank)

Includes set of 4 x black Fusion wheels, 1 x sandpaper, 2 x screw eyes, 2 x axles, straw wheel spacers, 4 x washers.

N14758:04

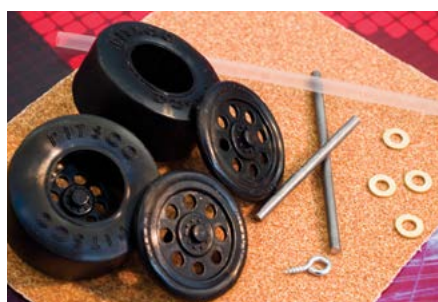

Bloodhound SSC Class Kit Bag (for one car, excluding balsa blank)

Includes 2 x PX rear wheels and 2 x LX front wheels, 1 x sandpaper, 2 x screw eyes, 2 x axles, straw wheel spacers, 4 x washers.

N14634:04



**Paint Stand
(for use with Bloodhound SSC & Formula 1® Class Cars)**

This new, improved design holds your car during the painting process. The car is suspended by the cartridge hole and once on the stand, can be rotated to paint all sides.

N54528



Axles

Use the strength of steel to mount your model wheels

Long Axles [65mm] (pack of 100).

N53341

Short Axles [43mm] (pack of 100).

N53728



Screw Eyes

Use these screw eyes to keep your car on the track

1/4" Screw Eyes [6.34mm] for use with Bloodhound SSC Class Cars (pack of 100).

N15109

1" Screw Eyes [25.4mm] for use with Formula 1® Class Cars (pack of 100).

N53693

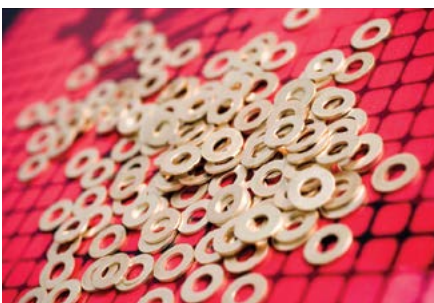

Washers

Reduce friction between the wheel and the car body.

Washers for use with Bloodhound SSC & Formula 1® Class Cars [4mm] (pack of 100).

N15194

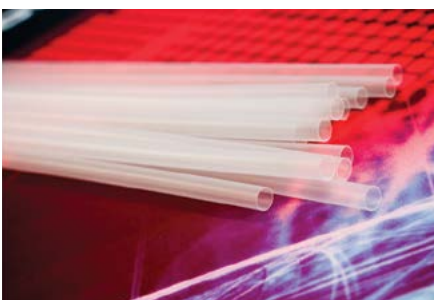

Straw Wheel Spacers

For use as axle bushings

Straw Wheel Spacers for use with Bloodhound SSC & Formula 1® Class Cars (pack of 500).

N33890

F1 Consumables

F1 IN SCHOOLS EQUIPMENT & CONSUMABLES



Decal Stickers

Decal Stickers
[pack of 25 sheets]

NF1009



TEST

Smoke Tunnel Including Fog Maestro Smoke Generator

A harmless smoke-like vapour passes through the Smoke Tunnel demonstrating airflow around the object.

N13277



Fog Maestro Smoke Generator

Fog Maestro Smoke Generator inc. 1 litre of Fog Fluid (Generator can be used with the Smoke Tunnel or Scout Wind Tunnel).

N25100

1 Litre of Fog Fluid

N56805



Scout Wind Tunnel

A wind tunnel specifically designed to measure frontal drag on F1® cars. It is 1240mm in length and features a powerful motor that draws air through at approx 40mph. Includes 1 Bottle of Manometer Oil.

N24761

Replacement Bottle of Manometer Oil.

N59108



RACE

Elevated Racetrack

25 Metre Track
[includes 11 sections and 12 legs].

N22049



F1® Race System

Designed for use with the Elevated Racetrack, the F1® Race System includes:
 1 x start gate, 1 x finish gate, 2 x launch triggers, 2 x launchers, 1 x power supply, 1 x control box and Race Time Management Software.

N32483



Track Banners

F1 in Schools Banners for use with Elevated Racetrack, featuring chequered flag borders and F1 logo (complete with velcro to attach to track)

NPB002



Test Cartridges

8 Gram Test Cartridges for Long Track (pack of 360). (for test only. NOT suitable for competition).

B103002A



Competition Cartridges

8 Gram Competition Cartridges for Long Track (pack of 120).

N53337

4 Gram Competition Cartridges for Short Track (pack of 120).

N53338



Deceleration Towels

Set of 2 deceleration towels. (Used to stop the cars at the end of the track.)

N18060

4x4 Starter Kit & Track Elements

LAND ROVER 4X4 IN SCHOOLS STARTER KIT & TRACK ELEMENTS

Starter Kit

Product Code: 4x40001

Land Rover 4x4 in Schools Starter Kit

Any team entering the Land Rover 4x4 in Schools Technology Challenge for the first time can opt to enter the Beginners Class of the Challenge by purchasing a Land Rover 4x4 in Schools Starter Kit.

The Starter Kit consists of all the essential components to get you started in the challenge: Horizon 1/18 scale Rock Crawler, 2.4 MHz Transmitter, 2.4 MHz Receiver, Battery Pack and Battery Charging Unit.



Land Rover 4x4 in Schools Track

Product Code: 4x40200

Official Land Rover 4x4 in Schools Track comprising full Staging and 14 Track Elements

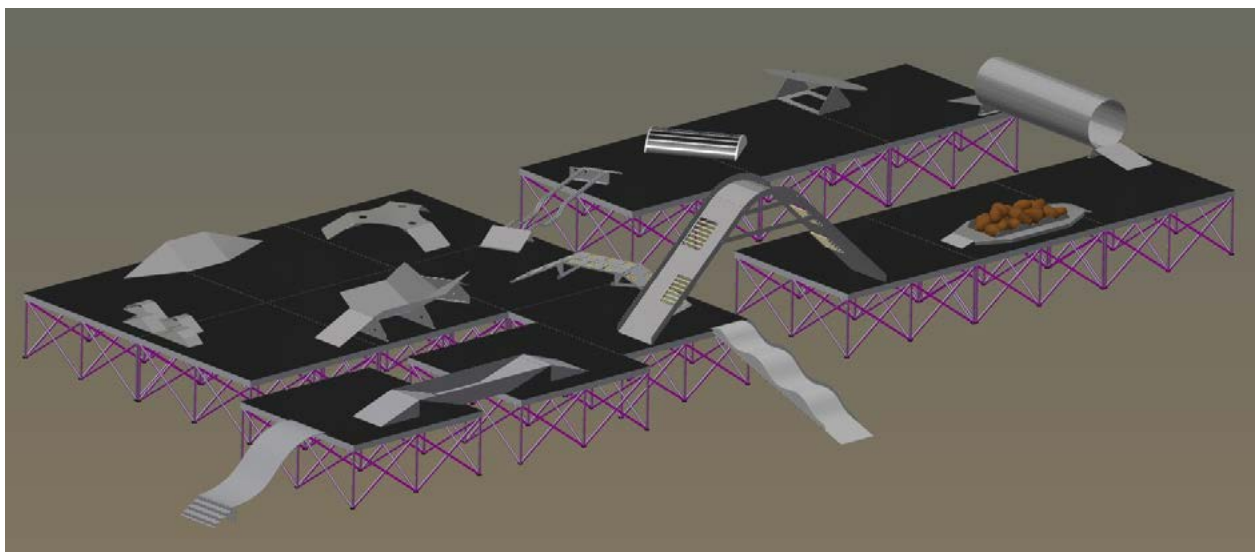



TRACK ELEMENTS



Entry Ramp

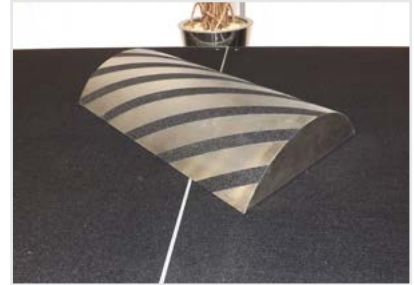

Camber Dome



Articulation



V-Gully Traverse

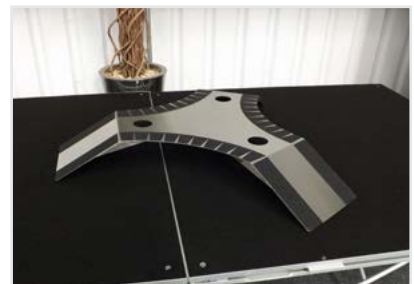

Hub



Pipe Bridge



Tunnel



See Saw



Off Ramp



Hill Climb



Low Mu Traverse



Side Slope



Rock Crawl



Water Tank Test

Denford Consumables

MATERIALS & CONSUMABLES



American Maple Wood Block

A creamy white hardwood with a close grain and fine, even texture.

Easy to work and finish, without the need for sanding.

Billet size: 160mm x 100mm x 20mm

Each	BI03509D
Pack of 50	BI03509G



Round Pine Billets

Ideal for use with the Rotary Fixture attachments.

Billet size: 65mm Dia. x 150mm Long

Pack of 10	BI03509J
------------	----------



FOAM

These rigid, closed cell foam blocks are ideal for the rapid machining of parts on the full range of Denford Milling Machines and Routers.

High Density Foam

Ideal for most 3D prototyping applications. Offering plenty of surface detail, it is commonly used in moulds for vacuum forming and is also suitable for painting.

Billet size: 150mm x 110mm x 45mm

Each	BI03508
Pack of 50	BI03508A



Billet size: 70mm Dia. x 150mm long

Each	BI03508DZ
Pack of 15	BI03508E

Ideal for use with the Denford 4th axis programmable rotary fixture.



Model Foam

A low density and low cost foam product with easy machining properties which is particularly suitable for quick 3D realisation of design ideas.

Billet size: 160mm x 100mm x 50mm

Each
pack of 50

BI03508B
BI03508Z



MODELLING BOARD

A high density (0.47gms per cubic metre) board ideal for high definition 3D work.

Modelling Board

For prototyping high quality models

Billet Size: 1500mm x 500mm x 50mm

Each

BI03508K

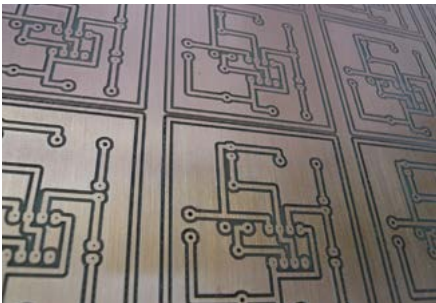

PCB BOARD

Ideal for use in conjunction with VR CNC Milling 5, PCB manufacturing feature.

Copper Coated Clad Pcb Board (Single Sided)

Size: 233.4mm x 160mm x 1.6mm

Each

4X40079



Photo Resist Coated PCB Board (Single Sided)

High quality dip coated positive working photoresist.

This high resolution photoresist contains a dye which gives a good contrast against the copper allowing boards to be easily inspected at the developing stage. Panels are protected by a specially designed light-proof blue film which allows them to be guillotined without the risk of fracturing the photoresist.

Size: 233.4mm x 160mm x 1.6mm

Each

4X40080

Denford Consumables

MATERIALS & CONSUMABLES



ALUMINIUM

Free cutting aluminium bars and billets are ideal for producing quick prototypes of metallic components. Easily polished, they yield professional looking component parts.

Aluminium Bar

Suitable for cutting on Denford Lathes.

Bar Size: 20mm Dia. x 55mm.

Non-Anodised

Each	BI03512A/1
Pack of 50	BI03512A

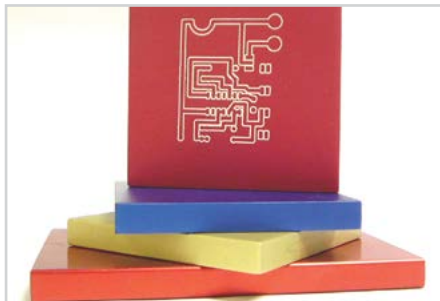

Aluminium Billet

Suitable for cutting on Denford Milling Machines.

Billet Size: 100mm x 100mm x 12mm.

Non-Anodised

Each	BI03511
Pack of 50	BI03511B

Red-Anodised

Each	BI03511A
Pack of 50	BI03511C



EXTRUDED ACRYLIC SHEET

Excellent thermoforming characteristics enabling the production of intricate, delicate shapes.

30 off 3mm **Red** 600mm x 300mm.

BI03523

30 off 3mm **Yellow** 600mm x 300mm.

BI03523A

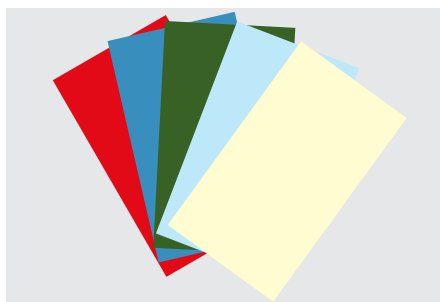

CAST ACRYLIC SHEETS

High quality, perfect surface finish and superb optical qualities.

30 off 3mm **Red** 600mm x 300mm.

BI03522

30 off 3mm **Blue** 600mm x 300mm.

BI03522A

30 off 3mm **Green** 600mm x 300mm.

BI03522B

30 off 3mm **Transparent Blue** 600mm x 300mm.

BI03522C

30 off 3mm **Transparent Yellow** 600mm x 300mm.

BI03522D



HIGH IMPACT POLYSTYRENE

Rigid, easy cutting thermoplastic used for 2D projects. Can be quickly "layered" in different colours to produce low cost nameplates etc. Easily held on temporary machine tables using heavy duty double sided tape.

Billet Size: 160mm x 90mm x 2mm.

White

Pack of 50	BI03501F
------------	----------

Multi-Coloured

Pack of 50	BI03501
------------	---------

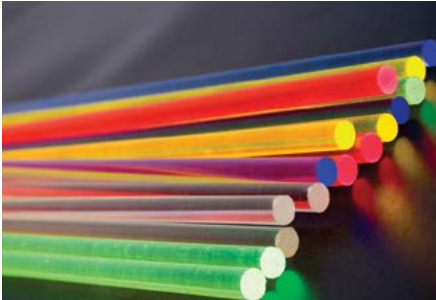

ACRYLIC RODS

1 metre x 6mm dia. fluorescent round – Red.	BI03524
1 metre x 6mm dia. fluorescent round – Yellow.	BI03524A
1 metre x 6mm dia. fluorescent round – Green.	BI03524B
1 metre x 6mm dia. fluorescent round – Blue.	BI03524C
1 metre x 6mm dia. round – Clear.	BI03524D



CUTTER PLOTTERS

Consumables Pack

Consumables for projects including:

- coloured vinyl
- coloured card
- button magnets
- mirrors
- double sided tape

BI01819CRC



VINYL

9 x 10 metre rolls of assorted coloured gloss finish 200mm width vinyl (for use with Cutter Plotters).

BI03521

Signmaking Vinyl Education Pack Includes:-

BI01819X

5M x 610mm Signmaking Vinyl in the following colours: white, black, buttercup, red, green, blue, ultramarine, gold and silver. 1M x 500mm Hotmark 60, soft heat sealable 50micron matt film (for use on fabrics) in the following colours: black, white, red and blue. High Tack Application Tape 100M x 300mm & 100M x 150mm. 5 x Plastic Applicator. 5 x Snap off Knife. 1 x Weeding Tweezer. 1 x Sheet Slitter.



DOUBLE SIDED TAPE

Heavy Duty

Size: 25mm x 33m

Pack of 10 BI03502A

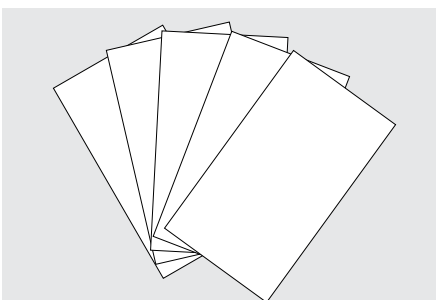

PLOTTER CARD

White Plotter Card (330gsm)

Size: 450mm x 320mm

Pack of 100 BI01819NE

On-Line Technical Forum

TECHNICAL SUPPORT AVAILABLE 24 HOURS A DAY, 7 DAYS A WEEK

Denford's Technical Forum is a free of charge on-line technical support service that is available to Denford customers 24 hours a day, 7 days a week.

“The technical forum has provided a wealth of information and support for our 20-year-old Denford CNC machine, in fact just as good as the support we receive for our brand new CNC Router!”

As well as offering comprehensive technical support, Denford's On-Line Technical Forum enables customers to share ideas and projects with other users. Media such as teaching material, project work, PDF's, images, drawings and text documents are easily attached to messages for all users to view and comment on.

You can also read the latest Denford news before anyone else, and keep track of machine and software upgrades, some of which can be downloaded direct from the Technical Forum web site.

The On-Line Technical Forum has proved to be hugely popular with customers. One recent user posted a note to inform us that the Technical Forum has “provided a wealth of information and support for our 20-year-old Denford CNC machine, in fact just as good as the support we receive for our brand new CNC Router!”

Of course the traditional methods of phone and email are still available, but try out this new service by simply logging on to www.denfordata.com/bb/ and register.



Denford's On-Line Technical Forum is a free of charge service that can be accessed 24 hours a day, 7 days a week.

The On-Line Technical Forum is available to Denford customers, old and new, and it couldn't be easier to use. Just visit <http://www.denfordata.com/bb/> and register on line.....it's that simple.

Denford's On-Line Technical Forum opens up the traditional communication channels that can restrict customer and technical support, due to availability of staff, teaching commitments or different time zones.

A multitude of topics relating to Denford machines and software (both new and old) are covered within the forum, which is simple to search, and easy to use.

Denford's Technical Team and Denford customers from around the world regularly log on to the forum to offer support and advice and, most importantly, post a solution for all to see.



Scan this to view our website

