

Manual Motor Starters

Electronic Overload Relays

Thermal Overload Relays



Warm

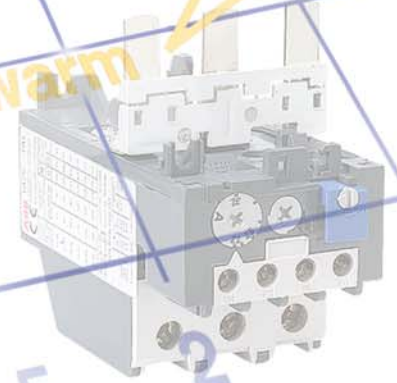

Tripping current as a multiple of the s

Motor Protection





Motor Protection

Manual Motor Starters
Thermal Overload Relays
Electronic Overload Relays

Contents

Manual Motor Starters

Overview	5/2
Ordering Details MS 116 and Accessories	5/4
Ordering Details MS 325 and Accessories	5/6
Ordering Details MS 450, MS 495 and Accessories	5/8
Technical Data	5/10
Coordination with Short-circuit Protection Devices	5/15

Thermal / Electronic Overload Relays

Overview	5/16
Coordination with Short-circuit Protection Devices	5/40

Thermal Overload Relays

Ordering Details T 7 DU	5/18
Ordering Details TA 25 DU ... TA 450 DU/SU and Accessories	5/19
Description	5/26
Technical Data	5/27
Tripping Curves	5/33

Electronic Overload Relays

Ordering Details E 16 DU and Accessories	5/24
Ordering Details E 200 DU ... E 1250 DU and Accessories	5/25
Technical Data	5/36
Tripping Curves	5/38

Additional Information

General Technical Data and Approvals	Section 7
Terminal Marking and Positioning	Section 8
Dimensions	Section 9

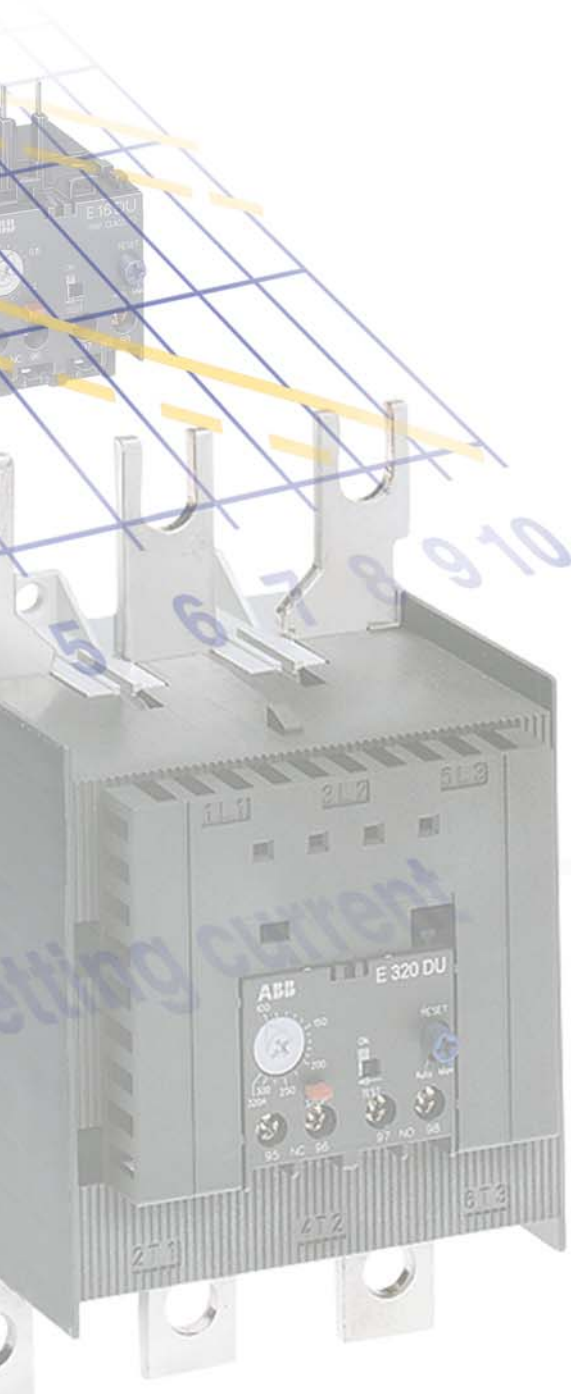

Manual Motor Starters MS...



with Thermal and Magnetic Protection



Manual Motor Starters

		Types	MS 116	MS 325
Setting ranges	Number		11	13
	from		0.16 ... 0.25 A	0.16 ... 0.25 A
	to		10 ... 16 A	20 ... 25 A

Mounting possibilities onto 3-pole contactors

		Types	A 9	A 12	A 16	A 26	A 9	A 12	A 16	A 26
 a.c. operated contactor range Connecting link	Types		BEA 16/116	BEA 26/116		BEA 16/325	BEA 26/325			
	Types									
 d.c. operated contactor range Connecting link	Types		BEA 16/116AL	BEA 26/116AL		BEA 16/325AL	BEA 26/325AL			
	Types									

Mounting plates for starters

D.O.L starters	Types	Not required	PM 26-13	Not required	PM 26-13
Reversing starters	Types	PM 26-23		PM 26-23	

Accessories for Manual Motor Starters

Auxiliary switches - Front mounting	Types	HKF1-11 (1NO + 1NC)	HKF-11 (1NO + 1NC)
-------------------------------------	-------	----------------------------	---------------------------

Examples of Complete Assembly



Manual motor starter **MS 116..** + contactor **A 9..**
+ connecting link **BEA 16/116**



Manual motor starter **MS 325..** + contactor **A 26..**
+ connecting link **BEA 26/325** + mounting plate **PM26-13**

Manual Motor Starters MS..

with Thermal and Magnetic Protection



MS 450	
7	
11 ... 16 A	
40 ... 50 A	

MS 495	
6	
28 ... 40 A	
80 ... 100 A	

Larger ratings: **Tmax** circuit breakers
(Please consult us)

A 30	A 40	A 50
BEA 40/450		BEA 50/450

A 50	A 63	A 75	A 95	A 110
BEA 75/495			BEA 110/495	

Larger ratings: **A 145 ... A 300** contactors
(Please consult us)

AL 30	AL 40	AE 50
-		BEA 50/450

AE 50	AE 63	AE 75	AE 95	AE 110
BEA 75/495			BEA 110/495	

Larger ratings: **AF 145 ... AF 300** contactors
(Please consult us)

-	
-	

-	
-	

-	
-	

HK4-11 (1NO + 1NC)

HK4-11 (1NO + 1NC)

-



Manual motor starter **MS 450** + contactor **A 40..**
+ connecting link **BEA 40/450**

Manual motor starter **MS 495** + contactor **A 110..**
+ connecting link **BEA 110/495**

Circuit breaker **Tmax** + contactor **A 145..**

Manual Motor Starter MS 116

Ordering details



MS 116

Type	Setting range	Order code	Packing Unit	Weight/ piece
	A...A		piece	kg
MS 116 with thermal and electromagnetic trips, short-circuit breaking capacity up to 50 kA				
MS 116 - 0.25	0.16 ... 0.25	1SAM 250 000 R1002	1	0.268
MS 116 - 0.4	0.25 ... 0.40	1SAM 250 000 R1003	1	0.268
MS 116 - 0.63	0.40 ... 0.63	1SAM 250 000 R1004	1	0.268
MS 116 - 1.0	0.63 ... 1.00	1SAM 250 000 R1005	1	0.268
MS 116 - 1.6	1.00 ... 1.60	1SAM 250 000 R1006	1	0.268
MS 116 - 2.5	1.60 ... 2.50	1SAM 250 000 R1007	1	0.268
MS 116 - 4	2.50 ... 4.00	1SAM 250 000 R1008	1	0.268
MS 116 - 6.3	4.00 ... 6.30	1SAM 250 000 R1009	1	0.268
MS 116 - 10.0	6.30 ... 10.00	1SAM 250 000 R1010	1	0.268
MS 116 - 12.0	8.00 ... 12.00	1SAM 250 000 R1012	1	0.268
MS 116 - 16.0	10.00 ... 16.00	1SAM 250 000 R1011	1	0.268

>> Manual Motor Starter Technical Catalogue available on request

Manual Motor Starter MS 116

Ordering details



HKF 1-11



Padlock + 2 keys + lock adapter

Add-on accessories

These parts can be provided in addition to the **MS 116**; they must be installed by the user.

Type	Features	Order code	Packing Unit	Weight/ piece
Auxiliary switches, for front mounting				
HKF1-11	1 NO + 1 NC	1SAM 201 901 R1001	10	0.011
Auxiliary switches with leading contacts, also to use with undervoltage release				
HK1-20L	2 NO leading contacts	1SAM 201 902 R1004	10	0.036
Auxiliary switches, lateral mounting, right side				
HK1-11	1 NO + 1 NC	1SAM 201 902 R1001	10	0.036
HK1-20	2 NO	1SAM 201 902 R1002	10	0.036
HK1-02	2 NC	1SAM 201 902 R1003	10	0.036
Shunt release, lateral mounting, left side				
AA1-24	24 V, 50/60 Hz	1SAM 201 910 R1001	10	0.100
AA1-110	110 V, 50/60 Hz	1SAM 201 910 R1002	10	0.100
AA1-230	200-240 V, 50/60 Hz	1SAM 201 910 R1003	10	0.100
AA1-400	350-415 V, 50/60 Hz	1SAM 201 910 R1004	10	0.100
Signal contact for general "tripped" signal, lateral mounting, right side				
SK1-11	1 NO + 1 NC	1SAM 201 903 R1001	10	0.036
SK1-20	2 NO	1SAM 201 903 R1002	10	0.036
SK1-02	2 NC	1SAM 201 903 R1003	10	0.036
Undervoltage release, lateral mounting, left side				
UA1-24	24 V, 50 Hz	1SAM 201 904 R1001	10	0.102
UA1-48	48 V, 50 Hz	1SAM 201 904 R1002	10	0.102
UA1-60	60 V, 50 Hz	1SAM 201 904 R1003	10	0.102
UA1-120	110 V 50 Hz/120 V 60 Hz	1SAM 201 904 R1004	10	0.102
UA1-208	208 V, 60 Hz	1SAM 201 404 R1008	10	0.102
UA1-230	230 V 50 Hz/240 V 60 Hz	1SAM 201 904 R1005	10	0.102
UA1-400	400 V, 50 Hz	1SAM 201 904 R1006	10	0.102
UA1-415	415 V 50 Hz/480 V 60 Hz	1SAM 201 904 R1007	10	0.102
Locking device				
SA1	lock adapter	GJF1 101 903 R0001	10	0.004
SA2	padlock + 2 keys	GJF1 101 903 R0002	10	0.004
SA3	lock adapter + padlock + 2 keys	GJF1 101 903 R0003	1	0.050

>> Connecting Link for Contactor Mounting page 4/28

Manual Motor Starter MS 325

Ordering details



MS 325

Type	Setting range	Order code	Packing Unit piece	Weight/ piece kg
	A...A			
MS 325 with thermal and electromagnetic trips, short-circuit breaking capacity up to 100 kA, resp.50 kA				
MS 325 – 0.25	0.16 ... 0.25	1SAM 150 000 R1002	1	0.347
MS 325 – 0.4	0.25 ... 0.40	1SAM 150 000 R1003	1	0.347
MS 325 – 0.63	0.40 ... 0.63	1SAM 150 000 R1004	1	0.347
MS 325 – 1	0.63 ... 1.00	1SAM 150 000 R1005	1	0.347
MS 325 – 1.6	1.00 ... 1.60	1SAM 150 000 R1006	1	0.347
MS 325 – 2.5	1.60 ... 2.50	1SAM 150 000 R1007	1	0.347
MS 325 – 4	2.50 ... 4.00	1SAM 150 000 R1008	1	0.347
MS 325 – 6.3	4.00 ... 6.30	1SAM 150 000 R1009	1	0.347
MS 325 – 9	6.30 ... 9.00	1SAM 150 000 R1010	1	0.347
MS 325 – 12.5	9.00 ... 12.50	1SAM 150 000 R1011	1	0.347
MS 325 – 16	12.50 ... 16.00	1SAM 150 000 R1012	1	0.347
MS 325 – 20	16.00 ... 20.00	1SAM 150 000 R1013	1	0.347
MS 325 – 25	20.00 ... 25.00	1SAM 150 000 R1014	1	0.347

>> Manual Motor Starter Technical Catalogue available on request

Manual Motor Starter MS 325

Ordering details

Add-on accessories

These parts can be provided in addition to the MS 325; they must be installed by the user.

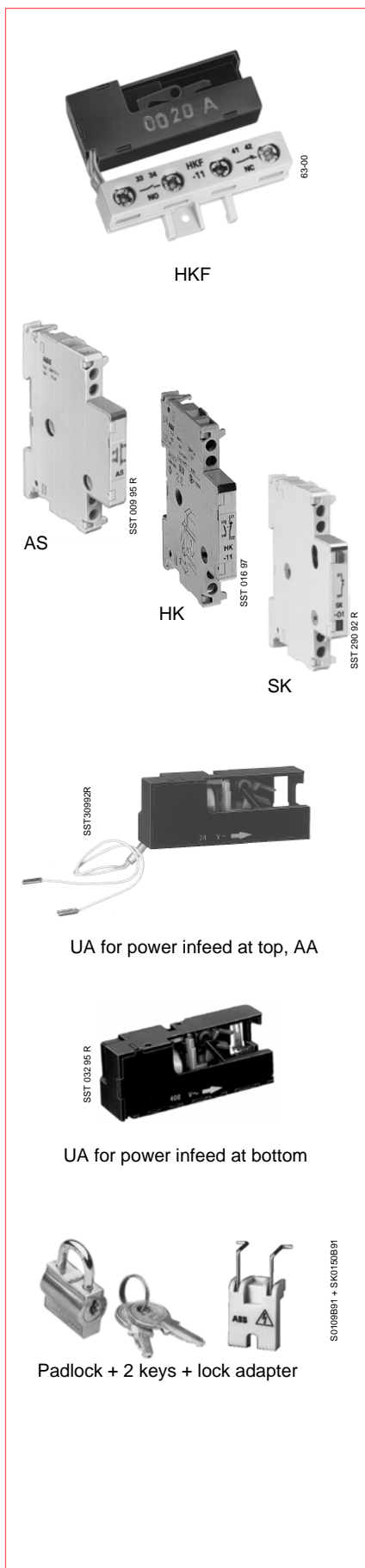

Type	Features	Order code	Packing Unit	Weight/ piece
------	----------	------------	--------------	---------------

Auxiliary switches, for front mounting (1)

HKF-11	1 NO + 1 NC	1SAM 101 928 R0001	10	0.020
HKF-20	2 NO	1SAM 101 928 R0002	10	0.020

Auxiliary switches, lateral mounting, left side, max. 2 pieces (2) (3)

HK-11	1 NO + 1 NC	1SAM 101 901 R0001	10	0.031
HK-20	2 NO (4)	1SAM 101 901 R0002	10	0.031
HK-02	2 NC	1SAM 101 901 R0003	10	0.031

Signal contact for general "tripped" signal, lateral mounting, left side max. 1 piece

SK-11	1 NO + 1 NC	1SAM 101 904 R0003	10	0.031
-------	-------------	--------------------	----	-------

Undervoltage release, slide-in (5)

UA, power infeed at bottom, U_c 400 V~		1SAM 101 902 R0400	10	0.020
UAF, power infeed at top, resp. connection of external voltage	U_c 24 V~	1SAM 101 903 R0024	10	0.020
	48 V~	1SAM 101 903 R0048	10	0.020
	60 V~	1SAM 101 903 R0060	10	0.020
	110 V~	1SAM 101 903 R0110	10	0.020
	230 V~	1SAM 101 903 R0230	10	0.020
	400 V~	1SAM 101 903 R0400	10	0.020
	415 V~	1SAM 101 903 R0415	10	0.020
	500 V~	1SAM 101 903 R0500	10	0.020

Open circuit shunt release, slide-in (6)

AA	24 ... 60 V AC/DC	1SAM 101 909 R0001	10	0.020
AA	110... 240 V AC/DC	1SAM 101 909 R0002	10	0.020

Terminal support, lateral mounting, left side to MS 325, HK and SK

AS, for UA, AA or as N/LS terminal		1SAM 101 905 R0001	10	0.031
------------------------------------	--	--------------------	----	-------

Locking device for MS 325

SA1, lock adapter		GJF1 101 903 R0001	10	0.004
SA2, padlock + 2 keys		GJF1 101 903 R0002	10	0.004
SA3, lock adapter + padlock + 2 keys		GJF1 101 903 R0003	1	0.050

- (1) Not simultaneously with UA/UA and AA
- (2) Max. 1 piece in conjunction with SK. SK must be mounted on first position
- (3) Pre-mating normally open contacts
- (4) Can be used together with UAF (power infeed at top) for safety circuit with Emergency Stop button (further information available on request)
- (5) Other voltages, in particular DC, on request
- (6) Recommendation: Connection of external voltage via terminal support AS

Accessories required for UL 508 type E application

Auxiliary switch, for short-circuit tripping signal

CK-11	1 NO + 1 NC	1SAM 101 943 R0001	10	0.025
-------	-------------	--------------------	----	-------

Power infeed block with high insulation

S3-M3		1SAM 101 938 R0004	10	0.025
-------	--	--------------------	----	-------

>> Connecting Link for Contactor Mounting page 4/28

Manual Motor Starters MS 450 and MS 495

Ordering details



MS 450



MS 495

Type	Setting range	Order code	Packing unit piece	Weight/ piece kg
	A . . . A			

MS 450 with thermal and electromagnetic trips, tripping class 10, short-circuit breaking capacity up to 50 kA

MS 450 – 16	11 ... 16	1SAM 450 000 R1001	1	0.960
MS 450 – 20	14 ... 20	1SAM 450 000 R1002	1	0.960
MS 450 – 25	18 ... 25	1SAM 450 000 R1003	1	0.960
MS 450 – 32	22 ... 32	1SAM 450 000 R1004	1	0.960
MS 450 – 40	28 ... 40	1SAM 450 000 R1005	1	0.960
MS 450 – 45	36 ... 45	1SAM 450 000 R1006	1	0.960
MS 450 – 50	40 ... 50	1SAM 450 000 R1007	1	0.960

MS 495 with thermal and electromagnetic trips, tripping class 10, short-circuit breaking capacity up to 50 kA

MS 495 – 40	28 ... 40	1SAM 550 000 R1005	1	2.100
MS 495 – 50	36 ... 50	1SAM 550 000 R1006	1	2.100
MS 495 – 63	45 ... 63	1SAM 550 000 R1007	1	2.100
MS 495 – 75	57 ... 75	1SAM 550 000 R1008	1	2.100
MS 495 – 90	70 ... 90	1SAM 550 000 R1009	1	2.100
MS 495 – 100	80 ... 100 (1)	1SAM 550 000 R1010	1	2.100

(1) Max. motor current 95 A

>> Manual Motor Starter Technical Catalogue available on request

Manual Motor Starters MS 450 and MS 495

Ordering details



HK4-11



HKS4-02



SK4-11



release AA4



UA4-HK

Add-on accessories

These parts may be provided in addition to the MS 450 and MS 495. They must be mounted by the user.

Type	Order code	Packing unit	Weight/ piece
Auxiliary switches, for front mounting			
HK4-11, 1 NO + 1NC	1SAM 401 901 R1001	10	0.020
HK4-W, 1 Changeover	1SAM 401 901 R1002	10	0.020
Auxiliary switches, for lateral mounting, left side, max. 1 piece			
HKS4-11, 1 NO + 1 NC	1SAM 401 902 R1001	2	0.030
HKS4-20, 2 NO	1SAM 401 902 R1002	2	0.030
HKS4-02, 2 NC	1SAM 401 902 R1003	2	0.030
Pilot switch acc. to UL 508 type E application, for separate signalling of short-circuit and general tripping, lateral mounting, left side, max. 1 piece, also together with auxiliary switch (1)			
SK4-11 1 NO + 1 NC	1SAM 401 904 R1001	1	0.030
Terminal insulation barrier acc. to UL 508 type E application			
DX 495	1SAM 401 912 R1001	1	0.030
Undervoltage release, for lateral mounting, right side			
UA4, U _n 24 V 50 Hz	1SAM 401 905 R1004	1	0.120
UA4, 110 V 50 Hz	1SAM 401 905 R1001	1	0.120
UA4, 230 V 50 Hz / 240 V 60 H	1SAM 401 905 R1002	1	0.120
UA4, 400 V 50 Hz	1SAM 401 905 R1003	1	0.120
Undervoltage release with leading auxiliary switch 2 NO, for lateral mounting, right side			
UA4-HK, U _n 230 V 50 Hz / 240 V 60 Hz	1SAM 401 906 R1001	1	0.130
UA4-HK, 400 V 50 Hz	1SAM 401 906 R1002	1	0.130
Shunt release, lateral mounting, left side (2)			
AA4, 20-70 V, 50/60 Hz/DC	1SAM 401 907 R1001	1	0.110
AA4, 70-190 V, 50/60 Hz/DC	1SAM 401 907 R1002	1	0.110
AA4, 190-330 V, 50/60 Hz/DC	1SAM 401 907 R1003	1	0.110
AA4, 330-500 V, 50/60 Hz/DC	1SAM 401 907 R1004	1	0.110

(1) Mounting sequence: motor protection switch, pilot switch, auxiliary switch.

(2) Max. ON time: 5 seconds, see also "Technical Data" page.

5

>> Connecting Link for Contactor Mounting page 4/28

Manual Motor Starters MS 116, MS 325, MS 450, MS 495

Technical data

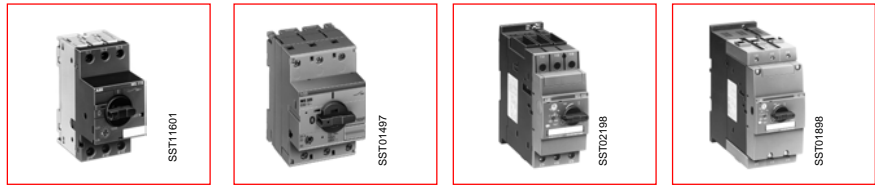

Manual motor starter	Type	MS 116	MS 325	MS 450	MS 495
----------------------	------	--------	--------	--------	--------

General technical data

Standards:	IEC 60947-1 / IEC 60947-2 / IEC 60947-4-1 / IEC 60947-5-1 EN 60947-1 / EN 60947-2 / EN 60947-4-1 / EN 60947-5-1			
Disconnecter characteristics (to IEC/EN 60947-1)	yes	yes	yes	yes
Mechanical service life in operating cycles	100.000	100.000	50.000	
Permissible ambient temperature				
- open °C	- 20... + 55/70 (1)	- 25 ... + 55 (1)	- 20 ... + 60/70 (1)	
- encapsulated (in protective housing) °C	on request	- 25 ... + 40	- 20 ... + 35	
- Storage temperature °C	- 50 ... + 80	- 50 ... + 80	- 50 ... + 80	
Temperature compensation	with			
Mounting position	any			
Permissible altitude m	3000	3000	2000	
Permissible resistance to vibrations (2) (IEC 60068-2-6)	10-150 Hz Amplitude 5 g	10-150 Hz Amplitude 5 g	on request	on request
Permissible resistance to shocks sinusoidal shock (IEC 60068-2-27)	25 g (11 ms)	15 g (11 ms)	on request	on request
Mounting (mounting hardware not included in scope of delivery)				
Screw fixing	see accessories	see accessories	2 x M5	2 x M5
Quick fastening on top-hat rail acc. to IEC 60715 / EN 60715	35 mm	35 mm	35 mm (15 mm high)	35 mm, 75 mm
	-	-	-	
Electrical connection of the main conductors (main circuits)				
Type	Screw terminal	Box terminal	Box terminal + bus	Box terminal
Screw	Pozidrive size 2	Pozidrive size 2	Pozidrive size 2 4 mm	Internal hexagon
Single-core 1 x mm ²	1 ... 4	1 ... 10	0.75 ... 35	2.5 ... 70
2 x mm ²	1 ... 4	1 ... 4	0.75 ... 25	2.5 ... 50
Stranded 1 x mm ²	1 ... 4 ⁽³⁾	1 ... 10	0.75 ... 35	2.5 ... 70
2 x mm ²	1 ... 4	-	0.75 ... 25	2.5 ... 50
Flexible 1 x mm ²	0.75 ... 2.5	1 ... 6	0.75 ... 25	2.5 ... 50
2 x mm ²	0.75 ... 2.5	-	0.75 ... 16	2.5 ... 35
of the auxiliary conductors (auxiliary circuits)				
Type	Screw terminal	Screw terminal (4)	Screw terminal	
Screw	Pozidrive size 2	Pozidrive size 1	Pozidrive size 2	
Single-core 1 x mm ²	1 ... 2.5	0.5 ... 2.5	0.5 ... 2.5	
2 x mm ²	1 ... 2.5 ⁽⁵⁾	0.5 ... 2.5	0.5 ... 2.5	
Flexible 1 x mm ²	0.75 ... 2.5	0.5 ... 2.5	0.5 ... 1.5	
2 x mm ²	0.75 ... 2.5	0.5 ... 2.5	0.5 ... 1.5	

(1) Operating conditions up to 70° C on request

(2) G-values refer to the mounting position subject to the highest shock sensitivity

(3) Also applies to auxiliary switches HKF1 and undervoltage release UA1

(4) For auxiliary switch HKF.. Pozidrive 2

(5) Applies to auxiliary switches HK1 and SK1

>> Manual Motor Starter Technical Catalogue available on request

Manual Motor Starters MS 116, MS 325, MS 450, MS 495

Technical data

Manual motor starter	Type	MS 116	MS 325	MS 450	MS 495
----------------------	------	--------	--------	--------	--------

General electrical data

Rated insulation voltage U_j to EN 60947	V AC	690	690	690	690
to CSA / UL / NEMA	V AC	600	600	600	600
Rated operating voltage U_e up to	V	690 AC/440 DC	690 AC/440 DC	690 AC/440 DC	690 AC/440 DC
Rated impulse withstand voltage U_{imp}	kV	6	- / 6	6	6
Rated continuous thermal current I_{th}	A	16	25	50	100
Rated frequency (1)	Hz	50/60			
Rated current ranges I_e (number of ranges)	A	0.1 ... 16 (11)	0.1 ... 25 (14)	11 ... 50 (7)	28 ... 100 (6)

Rated service short-circuit breaking capacity I_{CS} and max. permissible back-up fuses see "Manual Motor Starters" Catalogue.

DC rated operating voltage in the case of series connection of 3 main circuits (see wiring diagram)					
DC 1, 440 V	A	on request	25	50	100
DC 3, 440 V	A	on request	25	50	100
DC 5, 440 V	A	on request	25	50	100
Short circuit capacity for DC-rating		on request			

Auxiliary circuits

Load rating of the auxiliary circuits				
Minimum load at:	24 V DC mA 12 V DC mA	5 mA at 17 VDC -	5 10	5 mA at 17 VDC -
Auxiliary contact for front mounting	AC15	24V, 3.0 A 230V, 1.5 A	24V, 4.0 A 120V, 3.0 A 230V, 2.0 A	24V, 4.0 A 230V, 3.0 A
	DC13	24V, 1.0 A 60V, 0.7 A 110 V, 0.3 A 220 V, 0.1 A	24V, 2.0 A 60V, 2.5 A 110 V, 0.6 A 220 V, 0.25 A	24V, 1.0 A 48V, 0.3 A 60 V, 0.15 A
Auxiliary and signal contact	AC15	24V, 6.0 A 230V, 4.0 A 400 V, 3.0 A	24V, 4.0 A 120V, 3.0 A 230V, 2.0 A	24V, 6.0 A 230V, 4.0 A 400 V, 3.0 A
	DC13	24V, 2.0 A 110 V, 0.5 A 220 V, 0.25 A	24V, 2.0 A 60V, 2.5 A 110 V, 0.6 A 220 V, 0.25 A	24V, 1.0 A 110 V, 0.5 A 220 V, 0.25 A

(1) Correction factors for other frequencies on request



Manual Motor Starters MS 116, MS 325, MS 450, MS 495

Technical data

Manual motor starter	Type	MS 116	MS 325	MS 450	MS 495
----------------------	------	--------	--------	--------	--------

Release

Device for phase failure protection			included		
Electromagnetic tripping range			9.6 ... 14.4 x I _n	7.5 ... 12 I _n (1) 9 ... 14 I _n (2) 10 ... 15 I _n (3) 12.5 ... 17.5 I _n (4)	10.4 I _n ... 15.6 I _n
Undervoltage release					
Pick-up value		% of U _c	≥ 85	≥ 85	≥ 85
Drop-out value		% of U _c	35 ... 75	35 ... 75	35 ... 70
Power consumption	Pick-up	VA	9.0	0.9	20.2
	Hold	VA	3.0	0.9	7.2
Open-circuit shunt release					
Pick-up value		% of U _c	≥ 70	≥ 85	≥ 70
On-load factor		%	100	–	100
Power consumption	Pick-up	VA	9.0	110-240V: 13-61 (5)	on request
	Hold	VA	3.0	–	on request

Internal resistance values

Setting ranges		Resistance per phase			
from	A to	MS 116 Ω	MS 325 Ω	MS 450 mΩ	MS 495 mΩ
0.16	... 0.25	25.5	27.1	–	–
0.25	... 0.4	10.38	12.3	–	–
0.4	... 0.63	4.36	5.17	–	–
0.63	... 1.0	1.602	2.09	–	–
1.0	... 1.6	0.645	0.805	–	–
1.6	... 2.5	0.2795	0.34	–	–
2.5	... 4.0	0.1035	0.141	–	–
4.0	... 6.3	0.0433	0.051	–	–
6.3	... 9.0	–	0.0224	–	–
6.3	... 10.0	0.0217	–	–	–
8.0	... 12.0	0.0148	–	–	–
9.0	... 12.5	–	0.0122	–	–
10.0	... 16.0	0.0088	–	–	–
11.0	... 16.0	–	–	13.3	17.3
12.5	... 16.0	–	0.0081	–	–
14.0	... 20.0	–	–	8.74	11.3
16.0	... 20.0	–	0.0048	–	–
18.0	... 25.0	–	–	5.43	7.11
20.0	... 25.0	–	0.0035	–	–
22.0	... 32.0	–	–	3.60	4.75
28.0	... 40.0	–	–	2.56	3.28
36.0	... 45.0	–	–	1.80	–
36.5	... 50.0	–	–	–	2.24
40.0	... 50.0	–	–	1.46	–
45.0	... 63.0	–	–	–	1.40
57.0	... 75.0	–	–	–	0.95
70.0	... 90.0	–	–	–	0.60
80.0	... 100.0	–	–	–	0.54

(1) Current ranges 0.16 to 0.63 A

(2) Current ranges 1 to 2.5 A

(3) Current ranges 4 to 6.3 A

(4) Current ranges 9 to 25 A

(5) 24-60 V: 14.4-90 VA

Manual Motor Starter MS 116, MS 325

Technical data

Short-circuit protection MS 116, setting ranges, short-circuit strength and max. back-up fuses

		Maximum rated current of the short-circuit fuses if $I_{cc} > I_{cs}$ (1)																	
from	to	at 230 V AC			at 400 V AC			at 440 V AC			at 500 V AC			at 690 V AC					
		I_{cu} kA	I_{cs} kA	gL, gG A	I_{cu} kA	I_{cs} kA	gL, gG A	I_{cu} kA	I_{cs} kA	gL, gG A	I_{cu} kA	I_{cs} kA	gL, gG A	I_{cu} kA	I_{cs} kA	gL, gG A			
Setting ranges	0.1 ... 0.16	Short-circuit proof up to $I_{cc} = 50$ kA									Short-circuit proof up to $I_{cc} = 30$ kA								
	1.0 ... 1.6																		
	1.6 ... 2.5										10	10	25	10	10	25	5	5	25
	2.5 ... 4.0										6	6	25	6	6	25	2	2	25
	4.0 ... 6.3										6	6	63	6	6	63	2	2	40
	6.3 ... 10.0										6	6	63	6	6	63	2	2	50
	8.0 ... 12.0	25	25	80	25	25	80	6	6	63	6	6	63	2	2	50			
10.0 ... 16.0	16	16	80	16	16	80	4	4	63	4	4	63	2	2	63				

Short-circuit protection MS 325, setting ranges, short-circuit strength and max. back-up fuses

		Maximum rated current of the short-circuit fuses if $I_{cc} > I_{cs}$ (1)									
from	to	at 230 V AC		at 400 V AC		at 440 V AC		at 500 V AC		at 690 V AC	
		I_{cs} kA	gL, aM A	I_{cs} kA	gL, aM A	I_{cs} kA	gL, aM A	I_{cs} kA	gL, aM A	I_{cs} kA	gL, aM A
		Fuse types: Diazed, I.v.h.b.c., utilisation categories: gL, aM (VDE), gL/gG (IEC)									
Setting ranges	0.1 ... 0.16	Short-circuit proof									
	1.0 ... 1.6	No back-up fuse required up to $I_{cc} = 100$ kA									
	1.6 ... 2.5										
	2.5 ... 4.0										
	4.0 ... 6.3										
	6.3 ... 9.0										
	9.0 ... 12.5										
12.5 ... 16.0	75	80	45	80	40	80	27	80	4.5	50	
16.0 ... 20.0	60	100	40	100	25	100	25	100	4	50	
20.0 ... 25.0	55	100	35	100	22	100	22	100	3.5	50	
	50	125	30	125	20	125	20	125	3	50	

5

Short-circuit protection MS 325, setting ranges, short-circuit strength and max. back-up fuses

		Maximum rated current of the short-circuit fuses if $I_{cc} > I_{cs}$ (1)									
from	to	at 230 V AC		at 400 V AC		at 440 V AC		at 500 V AC		at 690 V AC	
		I_{cs} kA	gL, aM A	I_{cs} kA	gL, aM A	I_{cs} kA	gL, aM A	I_{cs} kA	gL, aM A	I_{cs} kA	gL, aM A
		Fuse types: Diazed, I.v.h.b.c., utilisation categories: gL, aM (VDE), gL/gG (IEC)									
Setting ranges	0.1 ... 0.16	Short-circuit proof									
	1.0 ... 1.6	No back-up fuse required up to $I_{cc} = 50$ kA									
	1.6 ... 2.5										
	2.5 ... 4.0										
	4.0 ... 6.3										
	6.3 ... 9.0										
	9.0 ... 12.5										
12.5 ... 16.0	45	80	27	80	4.5	50					
16.0 ... 20.0	40	100	25	100	4	50					
20.0 ... 25.0	35	100	22	100	3.5	50					
	30	125	20	125	3	50					

(1) I_{cs} = Rated service short-circuit breaking capacity, I_{cu} = Rated ultimate short-circuit capacity, I_{cc} = Prospective short-circuit current at installation location.
 $I_{cs} = I_{cu}$ in the case of MS 325 and MS 116.

>> Manual Motor Starter Technical Catalogue available on request

Manual Motor Starter MS 450, MS 495

Technical data

Short-circuit protection MS 450, setting ranges, short-circuit strength and max. back-up fuses

Setting ranges A	Maximum rated current of the short-circuit fuses if $I_{cu} > I_{cc}$ (1)														
	230 V AC			400 V AC			440 V AC			500 V AC			690 V AC		
	I_{cs} kA	I_{cu} kA	gL,gG A	I_{cs} kA	I_{cu} kA	gL,gG A	I_{cs} kA	I_{cu} kA	gL,gG A	I_{cs} kA	I_{cu} kA	gL,gG A	I_{cs} kA	I_{cu} kA	gL,gG A
11 ... 16	Short-circuit-proof No back-up fuse required up to $I_{cc} = 100kA$			25	50	100	25	50	100	6	12	63	3	5	63
14 ... 20				25	50	125	25	50	100	6	12	80	3	5	63
18 ... 25				25	50	125	15	30	100	6	12	80	3	5	63
22 ... 32				25	50	125	15	30	125	5	10	100	2	4	63
28 ... 40				25	50	160	15	30	125	5	10	100	2	4	63
36 ... 45				25	50	160	15	30	125	5	10	100	2	4	63
36 ... 50				25	50	160	15	30	125	5	10	100	2	4	80

Short-circuit protection MS 495, setting ranges, short-circuit strength and max. back-up fuses

Setting ranges A	Maximum rated current of the short-circuit fuses if $I_{cu} > I_{cc}$ (1)														
	230 V AC			400 V AC			440 V AC			500 V AC			690 V AC		
	I_{cs} kA	I_{cu} kA	gL,gG A	I_{cs} kA	I_{cu} kA	gL,gG A	I_{cs} kA	I_{cu} kA	gL,gG A	I_{cs} kA	I_{cu} kA	gL,gG A	I_{cs} kA	I_{cu} kA	gL,gG A
28 ... 40	Short-circuit-proof No back-up fuse required up to $I_{cc} = 100kA$			25	50	125	20	40	125	6	12	100	6	3	63
36 ... 50				25	50	125	20	40	125	6	12	100	6	3	80
45 ... 63				25	50	160	20	40	160	6	12	100	6	3	80
57 ... 75				25	50	160	20	40	160	4	8	125	5	3	100
70 ... 90				25	50	160	20	40	160	4	8	125	5	3	125
80 ... 100				25	50	160	20	40	160	4	8	125	5	3	125

(1) I_{cs} = Rated service short-circuit breaking capacity, I_{cu} = Rated ultimate short-circuit breaking capacity I_{cc} = Prospective short-circuit current at installation location.

Coordination with Short-circuit Protection Devices Manual Motor Starters and Contactors

A motor starter is typically made up of a switching device (contactor) and an overload protection device.

These two devices MUST be coordinated with an equipment capable of providing protection against short-circuit (SCPD: Short-Circuit Protection Device).

A complete data base of coordination tables, according to IEC 60947-4-1 (EN 60947-4-1), is available on the ABB Website: see www.abb.com/lowvoltage then go to the right menu: "Support", select: "Online Product Selection Tools".

Online Selected Optimized Coordination Tables

- [Introduction](#)
- [Instructions](#)
- [F.A.Q.](#)
- [Troubleshooting](#)



Short-Circuit Protection Device (SCPD) selection

Selection

[Manual Motor Starters \(MMS\)](#)

Direct-on-line starter Normal Startwith Manual Motor Controller 400 V, 16 kA, 50/60Hz, AC-3, EN/IEC 60947-4-1, type 1						
Motor	Manual Motor Controller			Limitor	Contactor	Table
Rated Output [kW]	Rated Current [A]	Type	Instantaneous tripping current [A]	Instantaneous tripping current [A]	Type	Max. allowed setting current [A]
0.06	0.22	MS116-0.25	3	0.16 - 0.25	A9	0.25
0.06	0.22	MSD11-FBP.0.25	3	0.16 - 0.25	B7	0.25

Protection against short-circuits and overloads with Manual Motor Starter

Complete coordination tables are available for the **Short-Circuit Protection Device (SCPD)**, the **Contactors** and the **Overload Protection Device** according to the **Rated Operational Voltage U_e** , the **Rated Short-circuit Current I_q** , the **Coordination Type** (type 1 or 2) and the **Motor Power**.

www.abb.com/lowvoltage **Online Selected Optimized Coordination Tables**

>> For Further Information see Section 7

Thermal overload relays TA... Electronic overload relays E...

Overview

Thermal overload relays

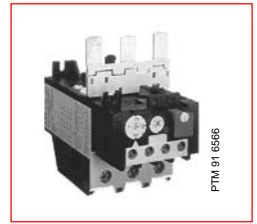
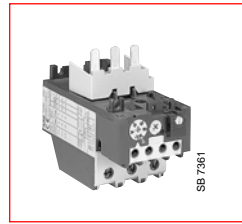
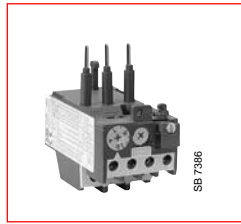
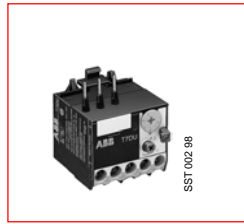

Type		T 7 DU	TA 25 DU	TA 42 DU	TA 75 DU
Setting ranges	Number	11	18	3	6
	from to	0.1 ... 0.16 A 9.0 ... 12.0 A	0.1 ... 0.16 A 24 ... 32 A	18 ... 25 A 29 ... 42 A	18 ... 25 A 60 ... 80 A

Mounting possibilities onto contactors

Mounting on	B 6, VB 6, VB 6A, BC 6, VBC 6, VBC 6A, B 7, VB 7, VB 7A, BC 7, VBC 7, VBC 7A	A 9 ... A 40 AL 9 ... AL 40 AL 9Z ... AL 16Z TAL 9 ... TAL 40	A 30, A 40 AL 30, AL 40 TAL 30, TAL 40	A 50 ... A 75 AF 50 ... AF 75 AE 50 ... AE 75 TAE 50 ... TAE 75
Mounting kit	No mounting kit required, direct mounting			

Accessories

Remote tripping coil	–	DS 25-A	–	–
Remote reset coil	–	DR 25-A	–	–
Main terminal shroud	Terminal shroud integrated			
Identification marker	BA 5-50			
Separate mounting kit	–	DB 25	–	DB 80

Thermal overload relays for special application

For motors with heavy starting	–	–	–	–
For ATEX motor protection	–	TA 25 DU ... V 1000	TA 42 DU ... V 1000	TA 75 DU ... V 1000

Electronic overload relays

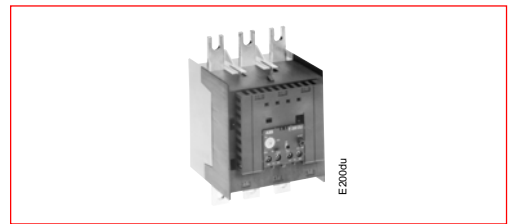
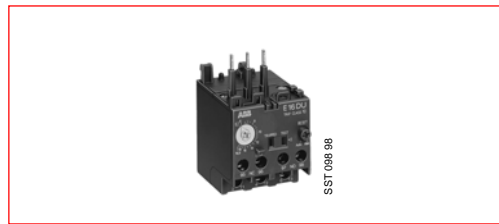

Type		E 16 DU	E 200 DU
Setting ranges	Number	5	1
	from to	0.1 ... 0.32 A 5.7 ... 18.9 A	60 A 200 A

Mounting possibilities onto contactors

Mounting on	B 6, VB 6, VB 6A, BC 6, VBC 6, VBC 6A, B 7, VB 7, VB 7A, BC 7, VBC 7, VBC 7A, A 9, A 12, A 16, AL 9, AL 12, AL 16, AL 9Z, AL 12Z, AL 16Z, TAL 9, TAL 12, TAL 16	A 145, A 185, AF 145, AF 185
Mounting kit	No mounting kit required, direct mounting	

Accessories



Main terminal shroud	Terminal shroud integrated	LT 200 E
Identification marker	BA 5-50	
Separate mounting kit	DB 16E	–

Electronic overload relays for special application

For motors with heavy starting	Class 10, 20, 30	Class 10, 20, 30 adjustable
For ATEX motor protection	PTB 02 ATEX 3041	PTB 02 ATEX 3044

Thermal overload relays TA... Electronic overload relays E...

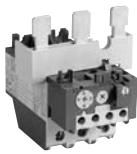
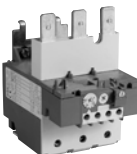
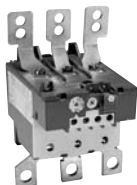
Overview

				
TA 80 DU	TA 110 DU	TA 200 DU	TA 450 DU/SU	
4	2	6	3	7
29 ... 42 A 60 ... 80 A	65 ... 90 A 80 ... 110 A	66 ... 90 A 150 ... 200 A	DU 130 ... 185 A 220 ... 310 A	SU 40 ... 60 A 220 ... 310 A
A 95, A 110, AF 95, AF 110, AE 95, AE 110, TAE 95, TAE 110		A 145, A 185, AF 145, AF 185	A 210 ... A 300, AF 210 ... AF 300	
No mounting kit required, direct mounting			DT 450/A	
–	–	–	DS 25-A	
–	–	–	DR 25-A	
Terminal shroud integrated		LT 200 A	–	
		BA 5-50		
DB 80	DB 200		–	
–	–	–	TA 450 SU	
TA 80 DU ... V 1000	TA 110 DU ... V 1000	TA 200 DU ... V 1000	TA 450 DU/SU ... V 1000	

5

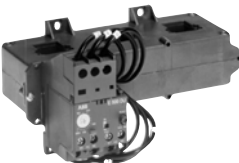
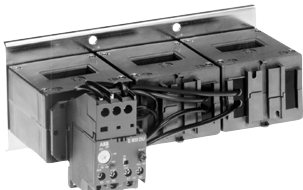
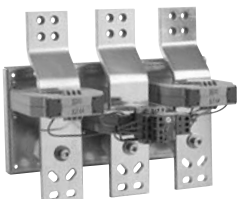
				
E 320 DU	E 500 DU	E 800 DU	E 1250 DU	
1	1	1	1	
100 A 320 A	150 A 500 A	250 A 800 A	375 A 1 250 A	
A 210, A 260, A 300, AF 210, AF 260, AF 300	AF 400, AF 460	AF 580, AF 750	AF 1350, AF 1650	
No mounting kits required, direct mounting	DT 500 / AF 460	DT 800 / AF 750	–	
LT 320 E	LT 500 E	LT 800 E	–	
		BA 5-50		
–	–	–	–	
Class 10, 20, 30 adjustable				
PTB 02 ATEX 3044			–	

Thermal overload relay T 7 DU

Ordering details

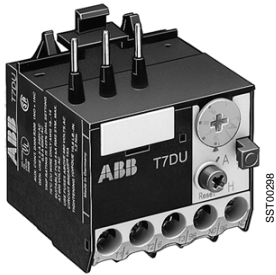

Type	Order code	Setting range	Packing unit	Weight / piece
		A ... A	piece	kg

**T7 DU Thermal overload relays
for mini contactors B 6, BC 6, B 6S, BC 6, VB 6, VBC 6, B 7, BC 7, B 7S, BC 7, VB 7, VBC 7,**

T 7 DU 0.16	1SAZ 111 301 R0001	0.1 ... 0.16	1	0.070
T 7 DU 0.24	1SAZ 111 301 R0002	0.16 ... 0.24	1	0.070
T 7 DU 0.4	1SAZ 111 301 R0003	0.24 ... 0.4	1	0.070
T 7 DU 0.6	1SAZ 111 301 R0004	0.4 ... 0.6	1	0.070
T 7 DU 1.0	1SAZ 111 301 R0005	0.6 ... 1.0	1	0.070
T 7 DU 1.6	1SAZ 111 301 R0006	1.0 ... 1.6	1	0.070
T 7 DU 2.4	1SAZ 111 301 R0007	1.6 ... 2.4	1	0.070
T 7 DU 4.0	1SAZ 111 301 R0008	2.4 ... 4.0	1	0.070
T 7 DU 6.0	1SAZ 111 301 R0009	4.0 ... 6.0	1	0.070
T 7 DU 9.0	1SAZ 111 301 R0010	6.0 ... 9.0	1	0.070
T 7 DU12.0	1SAZ 111 301 R0011	9.0 ... 12.0	1	0.070

>> Short-circuit Protection page 5/30

Thermal overload relays

TA25 DU, TA25 DU... V 1000, TA42 DU, TA42 DU... V 1000

Ordering details

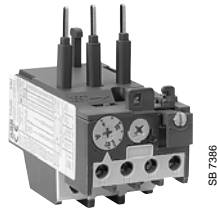

TA 25 DU

SB 7386

Type	Order code	Setting range	Pack- ing unit piece	Weight per piece kg
------	------------	---------------	-------------------------------	------------------------------

TA 25 DU for contactors A 9 ... A 40, AL 9 ... AL 40, AL 9Z ... AL 16Z, TAL 9 ... TAL 40

TA 25 DU 0.16	1SAZ 211 201 R1005	0.1 ... 0.16	1	0.150
TA 25 DU 0.25	1SAZ 211 201 R1009	0.16 ... 0.25	1	0.150
TA 25 DU 0.4	1SAZ 211 201 R1013	0.25 ... 0.4	1	0.150
TA 25 DU 0.63	1SAZ 211 201 R1017	0.4 ... 0.63	1	0.150
TA 25 DU 1.0	1SAZ 211 201 R1021	0.63 ... 1.0	1	0.150
TA 25 DU 1.4	1SAZ 211 201 R1023	1.0 ... 1.4	1	0.150
TA 25 DU 1.8	1SAZ 211 201 R1025	1.3 ... 1.8	1	0.150
TA 25 DU 2.4	1SAZ 211 201 R1028	1.7 ... 2.4	1	0.150
TA 25 DU 3.1	1SAZ 211 201 R1031	2.2 ... 3.1	1	0.150
TA 25 DU 4.0	1SAZ 211 201 R1033	2.8 ... 4.0	1	0.150
TA 25 DU 5.0	1SAZ 211 201 R1035	3.5 ... 5.0	1	0.150
TA 25 DU 6.5	1SAZ 211 201 R1038	4.5 ... 6.5	1	0.150
TA 25 DU 8.5	1SAZ 211 201 R1040	6.0 ... 8.5	1	0.150
TA 25 DU 11	1SAZ 211 201 R1043	7.5 ... 11	1	0.150
TA 25 DU 14	1SAZ 211 201 R1045	10 ... 14	1	0.150
TA 25 DU 19	1SAZ 211 201 R1047	13 ... 19	1	0.150
TA 25 DU 25	1SAZ 211 201 R1051	18 ... 25	1	0.150
TA 25 DU 32	1SAZ 211 201 R1053	24 ... 32 (1)	1	0.170

(1) With terminal block DX 25: 1 x 16 mm²

TA 25 DU ... V 1000 (ATEX) for contactors A 9 ... A 40, AL 9 ... AL 40, AL 9Z ... AL 16Z, TAL 9 ... TAL 40

TA 25 DU 0.16 V1000	1SAZ 211 301 R1005	0.1 ... 0.16	1	0.150
TA 25 DU 0.25 V1000	1SAZ 211 301 R1009	0.16 ... 0.25	1	0.150
TA 25 DU 0.4 V1000	1SAZ 211 301 R1013	0.25 ... 0.4	1	0.150
TA 25 DU 0.63 V1000	1SAZ 211 301 R1017	0.4 ... 0.63	1	0.150
TA 25 DU 1.0 V1000	1SAZ 211 301 R1021	0.63 ... 1.0	1	0.150
TA 25 DU 1.4 V1000	1SAZ 211 301 R1023	1.0 ... 1.4	1	0.150
TA 25 DU 1.8 V1000	1SAZ 211 301 R1025	1.3 ... 1.8	1	0.150
TA 25 DU 2.4 V1000	1SAZ 211 301 R1028	1.7 ... 2.4	1	0.150
TA 25 DU 3.1 V1000	1SAZ 211 301 R1031	2.2 ... 3.1	1	0.150
TA 25 DU 4.0 V1000	1SAZ 211 301 R1033	2.8 ... 4.0	1	0.150
TA 25 DU 5.0 V1000	1SAZ 211 301 R1035	3.5 ... 5.0	1	0.150
TA 25 DU 6.5 V1000	1SAZ 211 301 R1038	4.5 ... 6.5	1	0.150
TA 25 DU 8.5 V1000	1SAZ 211 301 R1040	6.0 ... 8.5	1	0.150
TA 25 DU 11 V1000	1SAZ 211 301 R1043	7.5 ... 11.0	1	0.150
TA 25 DU 14 V1000	1SAZ 211 301 R1045	10 ... 14	1	0.150
TA 25 DU 19 V1000	1SAZ 211 301 R1047	13 ... 19	1	0.150
TA 25 DU 25 V1000	1SAZ 211 301 R1051	18 ... 25	1	0.150
TA 25 DU 32 V1000	1SAZ 211 301 R1053	24 ... 32 (1)	1	0.170

(1) With terminal block DX 25: 1 x 16 mm²

TA 42 DU for contactors A 30, A 40, AL 30, AL 40, TAL 30, TAL 40

TA 42 DU 25	1SAZ 311 201 R1001	18 ... 25	1	0.330
TA 42 DU 32	1SAZ 311 201 R1002	22 ... 32	1	0.330
TA 42 DU 42	1SAZ 311 201 R1003	29 ... 42	1	0.330

TA 42 DU ... V1000 (ATEX) for contactors A 30, A 40, AL 30, AL 40, TAL 30, TAL 40

TA 42 DU 25 V1000	1SAZ 311 301 R1001	18 ... 25	1	0.330
TA 42 DU 32 V1000	1SAZ 311 301 R1002	22 ... 32	1	0.330
TA 42 DU 42 V1000	1SAZ 311 301 R1003	29 ... 42	1	0.330

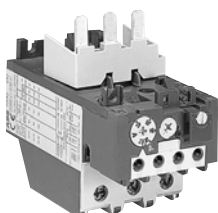

TA 42 DU

SB 7361

>> Short-circuit Protection page 5/30

Thermal overload relays TA 75 DU, TA 80 DU, TA 110 DU

Ordering details

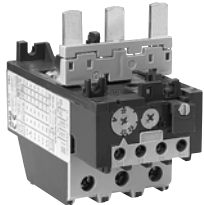

TA 75 DU

SB 7387

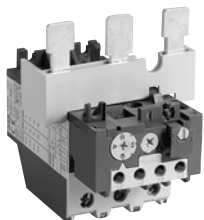

TA 80 DU

SB 7389

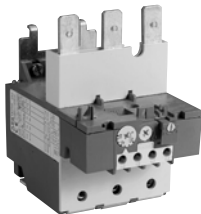

TA 110 DU

SB 7398

Type	Order code	Setting range		Pack- ing unit piece	Weight / piece kg
		A	... A		

TA 75 DU for contactors A 50 ... A 75, AE 50 ... AE 75, TAE 50 ... TAE 75, AF 50 ... AF 75

TA 75 DU 25	1SAZ 321 201 R1001	18	... 25	1	0.330
TA 75 DU 32	1SAZ 321 201 R1002	22	... 32	1	0.330
TA 75 DU 42	1SAZ 321 201 R1003	29	... 42	1	0.330
TA 75 DU 52	1SAZ 321 201 R1004	36	... 52	1	0.330
TA 75 DU 63	1SAZ 321 201 R1005	45	... 63	1	0.330
TA 75 DU 80	1SAZ 321 201 R1006	60	... 80	1	0.330

TA 75 DU ... V 1000 (ATEX) for contactors A 50 ... A 75, AE 50 ... AE 75, TAE 50 ... TAE 75, AF 50 ... AF 75

TA 75 DU 25 V 1000	1SAZ 321 301 R1001	18	... 25	1	0.330
TA 75 DU 32 V 1000	1SAZ 321 301 R1002	22	... 32	1	0.330
TA 75 DU 42 V 1000	1SAZ 321 301 R1003	29	... 42	1	0.330
TA 75 DU 52 V 1000	1SAZ 321 301 R1004	36	... 52	1	0.330
TA 75 DU 63 V 1000	1SAZ 321 301 R1005	45	... 63	1	0.330
TA 75 DU 80 V 1000	1SAZ 321 301 R1006	60	... 80	1	0.330

TA 80 DU for contactors A 95, A 110, AE 95, AE 110, TAE 95, TAE 110, AF 95, AF 110

TA 80 DU 42	1SAZ 331 201 R1003	29	... 42	1	0.360
TA 80 DU 52	1SAZ 331 201 R1004	36	... 52	1	0.360
TA 80 DU 63	1SAZ 331 201 R1005	45	... 63	1	0.360
TA 80 DU 80	1SAZ 331 201 R1006	60	... 80	1	0.360

TA 80 DU ... V 1000 (ATEX) for contactors A 95, A 110, AE 95, AE 110, TAE 95, TAE 110, AF 95, AF 110

TA 80 DU 42 V 1000	1SAZ 331 301 R1003	29	... 42	1	0.360
TA 80 DU 52 V 1000	1SAZ 331 301 R1004	36	... 52	1	0.360
TA 80 DU 63 V 1000	1SAZ 331 301 R1005	45	... 63	1	0.360
TA 80 DU 80 V 1000	1SAZ 331 301 R1006	60	... 80	1	0.360

TA 110 DU for contactors A 95, A 110, AE 95, AE 110, TAE 95, TAE 110, AF 95, AF 110

TA 110 DU 90	1SAZ 411 201 R1001	65	... 90	1	0.750
TA 110 DU 110	1SAZ 411 201 R1002	80	... 110	1	0.750

TA 110 DU ... V 1000 (ATEX) for contactors A 95, A 110, AE 95, AE 110, TAE 95, TAE 110, AF 95, AF 110

TA 110 DU 90 V1000	1SAZ 411 301 R1001	65	... 90	1	0.750
TA 110 DU 110 V1000	1SAZ 411 301 R1002	80	... 110	1	0.750

Thermal overload relays TA 200 DU, TA 450 DU/SU

Ordering details



SST1032.99

TA 200 DU

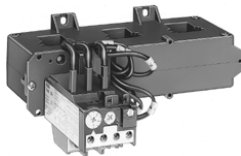

SST1030.99

TA 450 DU

Type	Order code	Setting range	For contactor	Packing unit piece	Weight / piece kg
		A ... A			

TA 200 DU ... for Normal starting time class 10 A

TA 200 DU 90	1SAZ 421 201 R1001	66 ... 90	A/AF 145, 185	1	0.750
TA 200 DU 110	1SAZ 421 201 R1002	80 ... 110	A/AF 145, 185	1	0.750
TA 200 DU 135	1SAZ 421 201 R1003	100 ... 135	A/AF 145, 185	1	0.750
TA 200 DU 150	1SAZ 421 201 R1004	110 ... 150	A/AF 145, 185	1	0.750
TA 200 DU 175	1SAZ 421 201 R1005	130 ... 175	A/AF 145, 185	1	0.750
TA 200 DU 200	1SAZ 421 201 R1006	150 ... 200	A/AF 145, 185	1	0.750

TA 200 DU ... V1000 (ATEX) for Normal starting time class 10

TA 200 DU 110 V1000	1SAZ 421 301 R1002	80 ... 110	A/AF 145, 185	1	0.750
TA 200 DU 130 V1000	1SAZ 421 301 R1003	100 ... 135	A/AF 145, 185	1	0.750
TA 200 DU 150 V1000	1SAZ 421 301 R1004	110 ... 150	A/AF 145, 185	1	0.750
TA 200 DU 175 V1000	1SAZ 421 301 R1005	130 ... 175	A/AF 145, 185	1	0.750
TA 200 DU 200 V1000	1SAZ 421 301 R1006	150 ... 200	A/AF 145, 185	1	0.750

Terminal shroud for TA 200 DU

LT 200/A	1SAZ 401 901 R1001			1	0.070
----------	--------------------	--	--	---	-------

Type	Order code	Setting range	For contactor	Packing unit piece	Weight / piece kg
		A ... A			

TA 450 DU ... for Normal starting time class 10 A

TA 450 DU 185	1SAZ 511 201 R1001	130 ... 185	A/AF 210, 260, 300	1	1.500
TA 450 DU 235	1SAZ 511 201 R1002	165 ... 235	A/AF 210, 260, 300	1	1.500
TA 450 DU 310	1SAZ 511 201 R1003	220 ... 310	A/AF 210, 260, 300	1	1.500

TA 450 DU ... V 1000 (ATEX) for Normal starting time class 10

TA 450 DU 185 V1000	1SAZ 511 301 R1001	130 ... 185	A/AF 210, 260, 300	1	1.500
TA 450 DU 235 V1000	1SAZ 511 301 R1002	165 ... 235	A/AF 210, 260, 300	1	1.500
TA 450 DU 310 V1000	1SAZ 511 301 R1003	220 ... 310	A/AF 210, 260, 300	1	1.500

TA 450 SU ... for Long starting time class 30

TA 450 SU 60	1SAZ 611 201 R1005	40 ... 60	A/AF 145 ... 300	1	1.500
TA 450 SU 80	1SAZ 611 201 R1006	55 ... 80	A/AF 145 ... 300	1	1.500
TA 450 SU 105	1SAZ 611 201 R1007	70 ... 105	A/AF 145 ... 300	1	1.500
TA 450 SU 140	1SAZ 611 201 R1008	95 ... 140	A/AF 145 ... 300	1	1.500
TA 450 SU 185	1SAZ 611 201 R1001	130 ... 185	A/AF 145 ... 300	1	1.500
TA 450 SU 235	1SAZ 611 201 R1002	165 ... 235	A/AF 145 ... 300	1	1.500
TA 450 SU 310	1SAZ 611 201 R1003	220 ... 310	A/AF 145 ... 300	1	1.500

TA 450 SU ... V 1000 (ATEX) for Long starting time class 30

TA 450 SU 60 V1000	1SAZ 611 301 R1005	40 ... 60	A/AF 145 ... 300	1	1.500
TA 450 SU 80 V1000	1SAZ 611 301 R1006	55 ... 80	A/AF 145 ... 300	1	1.500
TA 450 SU 105 V1000	1SAZ 611 301 R1007	70 ... 105	A/AF 145 ... 300	1	1.500
TA 450 SU 140 V1000	1SAZ 611 301 R1008	95 ... 140	A/AF 145 ... 300	1	1.500
TA 450 SU 185 V1000	1SAZ 611 301 R1001	130 ... 185	A/AF 145 ... 300	1	1.500
TA 450 SU 235 V1000	1SAZ 611 301 R1002	165 ... 235	A/AF 145 ... 300	1	1.500
TA 450 SU 310 V1000	1SAZ 611 301 R1003	220 ... 310	A/AF 145 ... 300	1	1.500

>> Short-circuit Protection page 5/31

Thermal overload relays Accessories

Ordering details

Mounting kits for thermal overload relay single set-up and mounting kits for mounting thermal overload relays onto contactors.

Relays TA 25 DU to TA 200 DU can be mounted onto contactors without mounting kits .

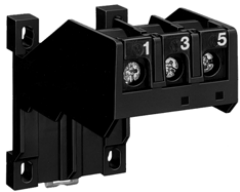

DB 25

SST 18291 R



DB 80

SST 193 91 R

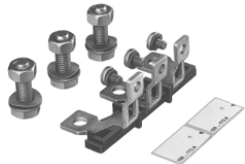

DB 200

SST 279 92 R



DX 25

SST 014 94 R

Type	Order code	for thermal overload relay	Mounting		Packing unit piece	Weight / piece kg
------	------------	----------------------------	----------	--	--------------------	-------------------

Mounting kits for single set-ups

DB 25/25 A	1SAZ 201 108 R0001	TA 25 DU 25 A	snapping onto 35 mm 		1	0.050
DB 25/32 A	1SAZ 201 108 R0002	TA 25 DU 32 A			1	0.075
DB 80	1SAZ 301 110 R0001	TA 42 DU TA 75 DU TA 80 DU			1	0.170
DB 200	1SAZ 401 110 R0001	TA 110 DU TA 200 DU	Screw mounting		1	0.230

Terminal block 10 mm²

DX 25	1SAZ 201 307 R0002	TA 25 DU ≤ 25 A and DB 25/25 A			1	0.030
--------------	---------------------------	-----------------------------------	--	--	---	-------

Identification markers for thermal overload relays TA 25 DU ... TA 450 DU/SU

BA 5-50	1SBN 110 000 R1000				Box	0.017
----------------	---------------------------	--	--	--	-----	-------

Type	Order code	for contactor	overload relays		Pack. unit piece	Weight / piece kg
------	------------	---------------	-----------------	--	------------------	-------------------

Mounting kits for mounting thermal overload relays onto contactors

DT 450/A 185	1 SAZ 501 901 R1001	A/AF 145, A/AF 185	TA 450 DU/SU		1	0.500
DT 450/A 300	1 SAZ 501 902 R1001	A/AF 260, A/AF 300	TA 450 DU/SU		1	0.750

Thermal overload relays Accessories

Ordering details



LT 200/A

1SFT1980399-125



DS 25-A

SST 203 91 R



DR 25-A

SST 204 91 R

Type	Order code	Mounting onto contactors	Pack. unit piece	Weight / piece kg
------	------------	--------------------------	------------------	-------------------

Terminal shroud for TA 200 DU

LT 185-AY between A 145/185 and TA 200 DU	1SFN 124 704 R1000	A/AF 145, A/AF 185	1	1.000
LT 200/A load side	1SAZ 401 901 R1001	A/AF 145, A/AF 185	1	0.070

Type	Order code	Description	Pack. unit piece	Weight / piece kg
------	------------	-------------	------------------	-------------------

Remote tripping control

The coil serves to remotely trip the thermal overload relays TA 25 DU, TA 450 DU/SU.
The coil is not approved for continuous operation. Pulse duration 0.2 ... 0.35 s.

DS 25-A-24	1SAZ 201 501 R0001	24 V	} Operating-voltage U_c at 50/60 Hz	1	0.100
DS 25-A-48	1SAZ 201 501 R0002	48 V		1	0.100
DS 25-A-110	1SAZ 201 501 R0003	110 V		1	0.100
DS 25-A-220/380	1SAZ 201 501 R0005	220/380 V		1	0.100
DS 25-A-500	1SAZ 201 501 R0006	500 V		1	0.100

Remote reset coil

The coil serves to reset the thermal overload relays TA 25 DU, TA 450 DU/SU.
The overload relay must be set to "manual reset" for this purpose.

The coil is not approved for continuous operation. Pulse duration 0.2 ... 0.35 s.

DR 25-A-24	1SAZ 201 504 R0001	24 V	} Operating-voltage U_c at 50/60 Hz	1	0.100
DR 25-A-48	1SAZ 201 504 R0002	48 V		1	0.100
DR 25-A-110	1SAZ 201 504 R0003	110 V		1	0.100
DR 25-A-220/380	1SAZ 201 504 R0005	220/380 V		1	0.100
DR 25-A-500	1SAZ 201 504 R0006	500 V		1	0.100

5

Circuit diagrams

TA 25 DU with DS 25-A

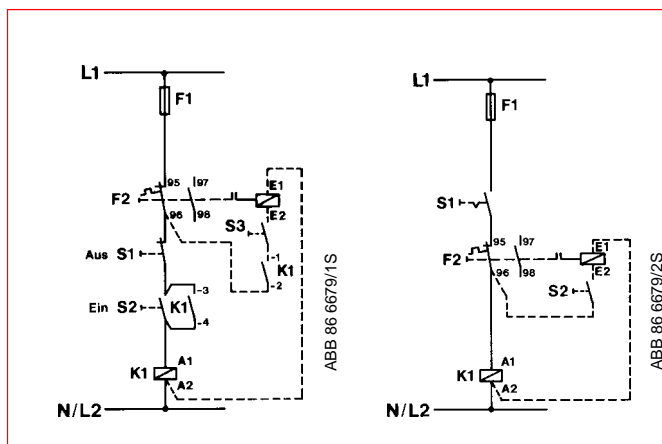

TA 25 DU with DR 25-A

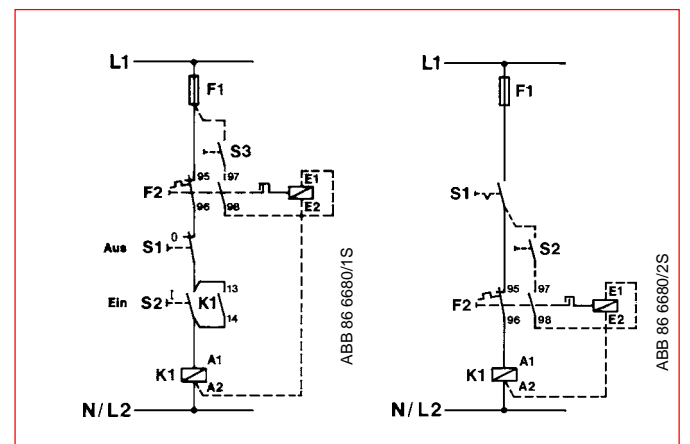

Electronic overload relay E 16 DU for contactors and mini contactors

Ordering details



E 16 DU



E 16 DU with A 9-30-10

Type	Order code	Setting range A ... A	Pack. unit kg	Weight / piece
------	------------	--------------------------	---------------------	-------------------

E 16 DU tripping class 10 for contactors B 6, B 7, BC 6, BC 7, B 6S, B 7S, A 9, A 12, A 16, AL 9, AL 12, AL 16, AL 9Z, AL 12Z, AL 16Z, TAL 9, TAL 12, TAL 16

E16 DU 0.32 10 ⁽¹⁾	1SAX 111 201 R0001	0.1 ... 0.32	1	0.150
E16 DU 1.0 10 ⁽¹⁾	1SAX 111 201 R0002	0.3 ... 1.00	1	0.150
E16 DU 2.7 10 ⁽¹⁾	1SAX 111 201 R0003	0.9 ... 2.70	1	0.150
E16 DU 6.3 10 ⁽¹⁾	1SAX 111 201 R0004	2.0 ... 6.30	1	0.150
E16 DU 18.9 10 ⁽¹⁾	1SAX 111 201 R0005	5.7 ... 18.90	1	0.150

E 16 DU tripping class 20 for contactors B 6, B 7, BC 6, BC 7, B 6S, B 7S, A 9, A 12, A 16, AL 9, AL 12, AL 16, AL 9Z, AL 12Z, AL 16Z, TAL 9, TAL 12, TAL 16

E16 DU 0.32 20 ⁽¹⁾	1SAX 111 301 R0001	0.1 ... 0.32	1	0.150
E16 DU 1.0 20 ⁽¹⁾	1SAX 111 301 R0002	0.3 ... 1.00	1	0.150
E16 DU 2.7 20 ⁽¹⁾	1SAX 111 301 R0003	0.9 ... 2.70	1	0.150
E16 DU 6.3 20 ⁽¹⁾	1SAX 111 301 R0004	2.0 ... 6.30	1	0.150
E16 DU 18.9 20 ⁽¹⁾	1SAX 111 301 R0005	5.7 ... 18.90	1	0.150

E 16 DU tripping class 30 for contactors B 6, B 7, BC 6, BC 7, B 6S, B 7S, A 9, A 12, A 16, AL 9, AL 12, AL 16, AL 9Z, AL 12Z, AL 16Z, TAL 9, TAL 12, TAL 16

E16 DU 1.0 30 ⁽¹⁾	1SAX 111 401 R0002	0.3 ... 1.00	1	0.150
E16 DU 2.7 30 ⁽¹⁾	1SAX 111 401 R0003	0.9 ... 2.70	1	0.150
E16 DU 6.3 30 ⁽¹⁾	1SAX 111 401 R0004	2.0 ... 6.30	1	0.150
E16 DU 18.9 30 ⁽¹⁾	1SAX 111 401 R0005	5.7 ... 18.90	1	0.150

⁽¹⁾ Not suitable for single-phase motors and direct current (d.c.) motors!

Type	Order code	for overload relay	Pack. unit piece	Weight / piece kg
------	------------	-----------------------	------------------------	-------------------------

Mounting kit for single set-ups on rail or plate

DB 16 E	1SAX 101 110 R 0001	E 16 DU	1	0.020
---------	---------------------	---------	---	-------

DB 16 E

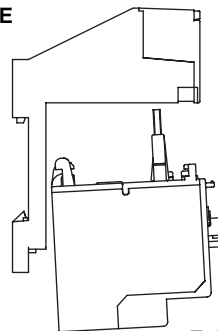

E 16 DU

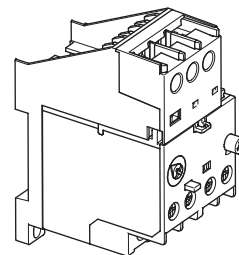

Electronic overload relays E 200 DU ... E 1250 DU

Ordering details



E 200 DU



E 320 DU

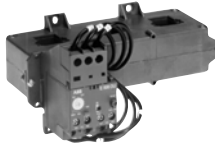

E 500 DU

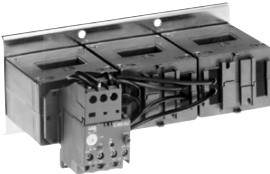

E 800 DU

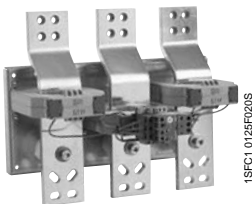

E 1250 DU



A 300 contactor with E 320 DU O/L relay and LT 320 E terminal shroud

Type	Order code	Setting range A ... A	for contactor	Pack. unit	Weight / piece kg
------	------------	--------------------------	---------------	---------------	-------------------------

Electronic overload relays - class 10, 20, 30 selectable

E 200 DU	1SAX 511 001 R0001	60 ... 200	A/AF 145, A/AF 185	1	1.120
E 320 DU	1SAX 611 001 R0002	100 ... 320	A/AF 210 ... A/AF 300	1	1.260
E 500 DU	1SAX 711 001 R0001	150 ... 500	A/AF 400, A/AF 460	1	1.210
E 800 DU	1SAX 811 001 R0001	250 ... 800	A/AF 580, A/AF 750	1	4.240
E 1250 DU ⁽¹⁾	1SFA 739 001 R1000	375 ... 1250	AF 1350, AF 1650	1	10.00

(1) Mounting kit with busbars for contactor mounting included.

Type	Order code	Description	Pack. unit piece	Weight / piece kg
------	------------	-------------	------------------------	-------------------------

Mounting kits for AF... contactors

DT 500/AF 460S	1SAX 701 902 R1011	Mounting kit for AF 400/460	1	0.750
DT 500/AF 460L	1SAX 701 902 R1001	Mounting kit for AF 400/460 with reversing connector	1	0.720
DT 800/AF 750S	1SAX 801 902 R1011	Mounting kit for AF 580/750	1	1.500
DT 800/AF 750L	1SAX 801 902 R1001	Mounting kit for AF 580/750 with reversing connector	1	1.400

The mounting kits include busbars and accessories for contactor mounting

Terminal shrouds

LT 200 E	1SAX 501 904 R0001	Terminal shroud for E 200 DU	1	0.120
LT 320 E	1SAX 601 904 R0001	Terminal shroud for E 320 DU	1	0.120
LT 500 E	1SAX 701 904 R0001	Terminal shroud for E 500 DU	1	0.240
LT 800 E	1SAX 801 904 R0001	Terminal shroud for E 800 DU	1	0.240

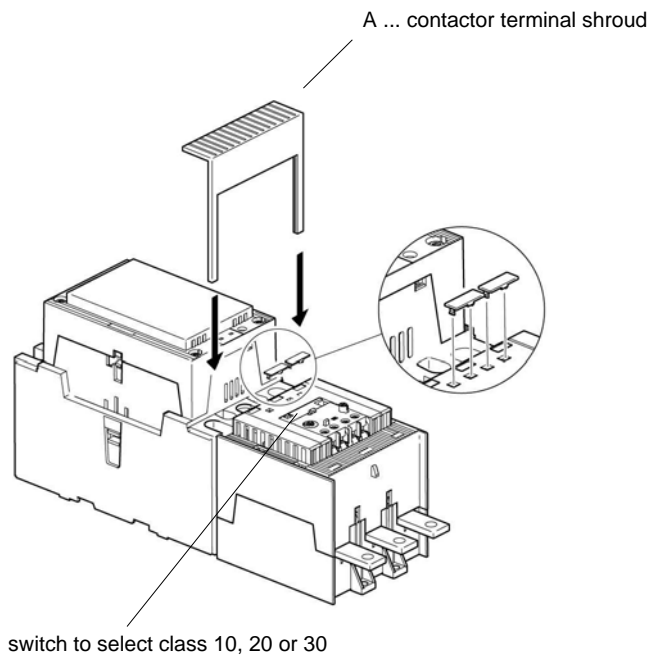

Thermal overload relays T... and TA...

Description

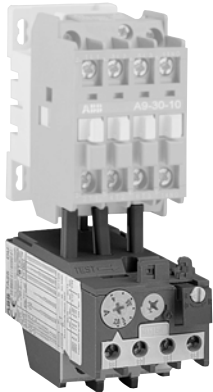

Application

Thermal overload relays are used in connection with contactors A, AF, AL, AL..Z, TAL, AE and TAE to protect motors with a rated operating voltages up to 690 V a.c. and 800 V d.c.

Product range

Standard relays

Types: T 7 DU, TA 25 DU, TA 42 DU, TA 75 DU, TA 80 DU, TA 110 DU, TA 200 DU, TA 450 DU/SU

- Relays **T 7** to **TA 200** are connected directly into the motor circuit and the motor current flows through them.
- Relays **TA 450 DU** is powered via converters with a linear characteristic.
- Relays **TA 450 SU** is powered via converters with saturation characteristic and therefore have longer tripping times. See "Protection with heavy starting".

Special designs

Thermal overload relays with different approvals and certificates.
Relays to protect ATEX motors.

Design and function

General

The relays and the accessories comply with the major international (IEC), European (EN) and national standards (DIN-VDE, NFC-UTE, BS, etc.) and meet the approval and licensing regulations necessary worldwide.

The thermal overload relays are three-pole relays

They have bimetallic releases (1 per phase) through which the motor current flows and are indirectly heated. The bimetallic releases bend subject to the influence of heating and this results in tripping of the relay. The auxiliary contacts change their switch position.

The relays feature a setting scale in Amperes. In compliance with international and national standards, the setting current is the rated **motor current** and not the tripping current (no tripping at $1.05 \times I$ setting current, tripping at $1.2 \times I$ setting current).

The **tripping curves** (starting from cold and warm state, three and two-phase) are shown in the next "Technical Data" pages.

The relays are constructed so that they protect themselves in the event of overload until the series-connected short-circuit protection trips, as shown in the tables.

Technical data

All relays feature:

- **Trip-free mechanism:** Tripping in the event of a fault is not prevented even if the Reset button is pressed.
- **Temperature compensation:** - see next "Technical Data" pages
- **Phase failure protection in accordance with IEC 60947-4-1:** This device shortens the tripping times in the event of phase failure and thus improves the motor protection within the limits of the setting range.
- **Tripping category:** **10 A**, in the case of thermal overload relays TA ... DU
30, in the case of thermal overload relays TA ... SU.
- **Reset and test functions**, see "Technical Data" pages.

Auxiliary contacts

The relays feature two integrated auxiliary contacts

- one NC contact, marked by 95 - 96
- one NO contact, marked by 97 - 98

The two contacts are electrically isolated and are thus suitable for use in two different circuits (control circuit and signalling circuit).

>> Protection with Heavy Starting	page 5/27
>> Thermal O/L Relays for ATEX Motors	page 5/34
>> Certification and Approvals	section 7

Thermal overload relays T 7 DU, TA 25 DU ... TA 450 DU

Technical data

Intermittent periodic duty

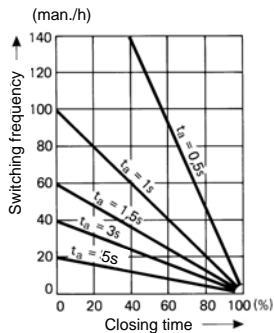

Switching frequency depending on duty ratio ED in %, t_a : Motor starting time

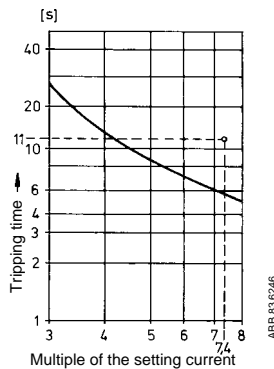

Tripping curve of overload relay TA .. starting from cold state

Switching frequency

Thermal overload relays T ... cannot be operated at any arbitrary switching frequency in order to avoid tripping. Applications involving up to 15 operations per hour are acceptable. Higher switching frequencies are permitted if the duty ratio and the motor starting time are allowed for and if the motor's making current does not appreciably exceed 6 times the rated operating current. Please refer to the adjacent diagram for guideline values for the permitted switching frequency.

Example: Starting time of the motor: 1 second
Duty ratio: 40 %
means a permitted switching frequency of max. 60 operations per hour

Use of the CUSTORAPID® motor protection is recommended for higher switching frequencies and alternating loading, e.g. for frequent starting and braking. Use of a combination of thermal overload relays and CUSTORAPID® is recommended in the case of locked rotors on motors with thermally critical rotors.

Protection with heavy starting

Relays TA 450 SU can be used for particularly severe starting conditions. The setting ranges specified in the "Ordering Details" tables apply to non-recurrent looping through of the cables. The relay may also be used for lower motor rated currents. This is achieved by looping the cables through several times. The setting range specified on the rating plate is inversely proportional to the number of cables looped through.

For instance: TA 450DU/SU with a setting range of 130 ... 185 A is also suitable for currents of 65 ... 92.5 A if the cables are looped through twice; the figures are 43.3 ... 61.6 A for looping the cables through three times.

Special version for ATEX motors

Relays TA 25 DU ... TA 450 DU / SU are suitable for protection of ATEX motors. They have been tested and approved by the "German National Standards Laboratory" (PTB) in Braunschweig, Germany.

When selecting the overload relay, check suitability on the basis of the tripping curves. The values for the ratio of pick-up current I_a to rated current I_n and the shortest t_E time are crucial, and these must be specified on the PTB Approval Certificate and on the motor's rating plate. The relay must trip within the t_E time, i.e. the tripping curve, starting from cold state, must run below the coordinate point I_a/I_n and the t_E time.

Example for suitability of an overload relay TA:

The motor with increased safety has the following data:
Output = 7.5 kW, $I_a/I_n = 7.4$, t_E time = 11 seconds.
In accordance with the adjacent tripping curve, the tripping time lies below the t_E time of the motor. The special relay version for ATEX motors differs from the normal version as follows:

Special test of the tripping times at the works

Special order code

Tripping curves for the individual setting ranges and the PTB Approvals Certificates may be ordered.

Reference numbers of the PTB:

ATEX certificate acc. to European Directive 94/9/EC: PTB 02 ATEX 3045 valid for all V1000 thermal overload relays TA 25, TA 42, TA 75, TA 80, TA 110, TA 200, TA 450 types.

5

Limit values for tripping at ambient temperatures other than 20 °C

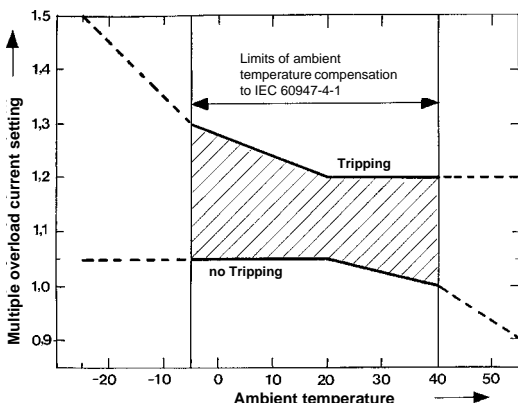

Ambient temperature compensation :

The overload relays are protected against influences of ambient temperature by a bimetallic compensation element which detects the ambient temperature. This design means that tripping occurs between -5 °C and +40 °C within the ranges defined by IEC 60947-4-1. See the adjacent curve for the extended range of -25 °C resp. +55 °C.

Example :

Tripping at -25 °C. Tripping occurs at ≤ 1.5 times the setting current.

Reset :

Types E 16 DU, T 7 DU, TA 25 DU ... TA 450 DU/SU feature a convertible Manual/ Automatic reset.



Condition as delivered :

Manual reset.

Thermal overload relays T... and TA...

Technical data

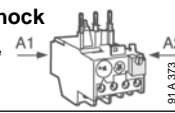
General technical data

Type		T 7 DU	TA 25 DU	TA 42 DU	TA 75 DU
Standards: (major international European and national standards)		IEC 60947-4-1, VDE 0660, NFC 63 650, BS 4941, EN 60947-4-1			
Rated insulation voltage U_i to IEC 158-1, IEC 60947-4-1	V	690		660/690	
Impulse withstand voltage U_{imp} to IEC 60947-4-1	kV	6		6	
Permissible ambient temperature – Storage temperature – for operation (compensated)	°C °C			– 40 to +70 – 25 to +55 (see curve for compensation limit values)	
Climatic resistance to DIN 50017		Resistant to changeable climate KFW, 30 cycles			
Mounting position		any, but please avoid vertical mounting position wherever possible			
Resistance to shock at rated current I_n • critical shock direction A1, A2	shock duration ms multiple of g	10		15	
		10		12	
Resistance to vibration: (±1 mm, 50 Hz)	multiple of g	4		8	
Mounting – onto contactor – with DB.. mounting kit		Clipped beneath the contactor, fixed by screws on its main terminals By screws: 2 x M4 or  35 mm acc. to IEC 60715/EN 60715			
Connection terminals and attachment type Main conductors (motor side)			TA25DU setting ranges: 0.1...0.16 A 24...32 A to 18...25 A		
• Screw terminals – Screw terminal – with terminal block – with busbars or cable lugs		M3.5 – –	M4 – –	– M5 –	M6 – –
• Tightening torque	Nm	1	1.2 ... 1.4	2 ... 2.4	3 ... 4
• Connection cross-sections – single-core or stranded – flexible with wire end ferrule – busbars	mm ² mm ² mm	2 x 0.75 ... 2.5 2 x 0.5 ... 1.5 –	2 x 1.5 ... 6 2 x 1.5 ... 4 –	1 x 10 2 x 0.75...6 –	1 x 2.5 ... 25 or 2 x 2.5 ... 16 1 x 2.5 ... 25 or 2 x 2.5 ... 10 –
Connections and auxiliary connectors • Screw terminal (screw size) – with self-disengaging clamping piece • Connection cross-section – single-core or stranded – flexible with wire end ferrule	mm ² mm ²	2 x 0.75 ... 2.5 2 x 0.5 ... 1.5	M 3.5		2 x 0.75 ... 4 2 x 0.75 ... 2.5
Enclosure to IEC 60947-1 / EN 60947-1, IEC 60529 / EN 60529		All terminals are protected against access to hazardous parts with back hand and finger in acc. with EN 50274 (no extra terminal shrouds are required up to and including TA 110 DU)			

Technical data of the conducting paths

Type	T7 DU	TA25 DU	TA42 DU	TA75 DU	TA80 DU	TA110 DU	TA200 DU	TA450 DU	TA450 SU
Number of paths	3								
Setting ranges	see "Ordering Details"								
Tripping class to IEC 60947-4-1 / VDE 0660, Part 1021	10 A							30	
Frequency range	0 ... 400							50/60	
Switching frequency without early tripping	up to 15 cycles/h or 60 cycles/h with 40 % if the breaking current does not exceed $6 \times I_n$ and the starting time does not exceed 1 s								
Resistance per phase in mΩ and heat dissipation per phase in W at maximum setting current	see next pages								
Required fuses for short-circuit protection	see next pages								

>> Temperature Compensation Limit Values page 5/27
>> Ordering Details pages 5/18 ... 5/21
>> Resistance per Phase pages 5/30, 5/31

>> Required Fuses pages 5/30, 5/31
>> Certifications and Approvals for T 7 O/L Relay section 6
>> Certifications and Approvals for TA 25 DU ... TA 75 DU O/L Relay section 7

Thermal overload relays TA...

Technical data

General technical data (cont.)

	TA 80 DU	TA 110 DU	TA 200 DU	TA 450 DU/SU
	IEC 60947-4-1, VDE 0660, NFC 63 650, BS 4941, EN 60947-4-1			
V	660/690			1000
kV	6			8
°C	- 40 to +70			
°C	- 25 to +55 (see curve for compensation limit values)			
	Resistant to changeable climate KFW; 30 cycles			
	any, but please avoid vertical mounting position wherever possible			
ms	15			
x g	12			
x g	8			
	M6 -	4 screws M5		
Nm	M6 - - 3 ... 4	HC, M8 - - 7.2 ... 9.6	- - M10 12 ... 16	- - M10 12 ... 16
mm ²	1 x 2.5 ... 25 or 2 x 2.5 ... 16	16 ... 35	25 ... 120	2 x 240
mm ²	1 x 2.5 ... 25 or 2 x 2.5 ... 10	16 ... 35	25 ... 95	2 x 240
mm	-	12 x 3	20 x 4 ... 5	25 x 5 ... 8
	M 3.5			
mm ²	2 x 0.75 ... 4			
mm ²	2 x 0.75 ... 2.5			
	All terminals are protected against access to hazardous parts with back hand and finger in acc. with EN 50274		All terminals are safe from finger-touch and protected against access to hazardous parts with back hand and finger in acc. with EN 50274 only with additional terminal shrouds.	

5

Thermal overload relays T... and TA...

Technical data

Resistances and power losses per phase
Short-circuit protection

Setting ranges from ... to A A	Short-circuit protection (fuses, circuit-breakers) Coordination type 2 (1)			Coordination type 1 (1)		Resistance per phase mΩ	Power loss per phase at upper current setting W
	gG A	aM A	S 223 K A	gG A	S 223 K		

Thermal overload relay T 7 DU

0.1 ... 0.16	0.5			20	K 6	62 300	1.6
0.16 ... 0.24	1			20		27 000	1.6
0.24 ... 0.40	2			20		11 700	1.9
0.4 ... 0.60	2			20		4 610	1.7
0.6 ... 1.00	4			20		1 660	1.7
1.0 ... 1.60	6			20		630	1.6
1.6 ... 2.40	6			20	K 10	270	1.6
2.4 ... 4.00	10			20		107	1.7
4.0 ... 6.00	10			20		49	1.8
6.0 ... 9.00	10			20	K 25	21	1.7
9.0 ... 12.00	20			20		10	1.4

Setting ranges from ... to A A	Short-circuit protection (fuses, circuit-breakers) Coordination type 2 (1)			Coordination type 1 (1)		Resistance per phase mΩ	Power loss per phase at upper current setting W
	gG A	aM A	S 223 K A	gG A	S 223 K		

Thermal overload relay TA 25 DU

0.1 ... 0.16	0.5	–	–	25	K6	85 850	2.2
0.16 ... 0.25	0.63	–	–	25		35 150	2.2
0.25 ... 0.40	1.25	–	0.5	25		13 750	2.2
0.4 ... 0.63	2	–	1.0	25		5 370	2.2
0.63 ... 1.00	4	2	1.0	25		2 190	2.2
1.0 ... 1.40	4	2	1.6	25		1 120	2.2
1.3 ... 1.80	6	4	2	25		670	2.2
1.7 ... 2.40	6	4	3	25	K10	383	2.2
2.2 ... 3.10	10	6	3	25		229	2.2
2.8 ... 4.00	10	6	4	25		137	2.2
3.5 ... 5.00	16	10	6	25		87.5	2.2
4.5 ... 6.50	20	16	8	25	K25	51.0	2.2
6.0 ... 8.50	25	20	10	25		30.4	2.2
7.5 ... 11.00	35	25	16	–		18.2	2.2
10 ... 14.00	35	25	16	–		11.2	2.2
13 ... 19.00	50	35	20	–	K40	6.3	2.3
18 ... 25.00	63	50	25	–		4.7	2.9
24 ... 32.00	80	63	32	–		3.2	3.3

Thermal overload relay TA 42 DU

18 ... 25	63	50	50	50	160	5.5	3.43
22 ... 32	80	63	50	50	160	2.89	2.91
29 ... 42	100	80	63	63	160	1.84	3.24

1) Coordination type 1 and 2, see "Terms and Technical Definitions".

Thermal overload relays TA...

Technical data

Resistances and power losses per phase
Short-circuit protection

Setting range from ... to A A	Short-circuit protection (fuses, circuit-breakers) Coordination type 2 (1)				Coordination type 1(1)		Resistance per phase mΩ	Power loss per phase at upper current setting W
	gG A	aM A	S 273 A	S 703 A	gG A			

Thermal overload relay TA 75 DU

18 ... 25	63	50	50	50	160		5.5	3.43
22 ... 32	80	63	50	50	160		2.89	2.91
29 ... 42	100	80	63	63	160		1.84	3.24
36 ... 52	125	100	63	80	160		1.3	3.51
45 ... 63	160	125	–	100	250		0.936	3.72
60 ... 80	200	160	–	100	250		0.615	3.94

Thermal overload relay TA 80 DU

29 ... 42	100	80	63	63	160		1.84	3.24
36 ... 52	125	100	63	80	160		1.3	3.51
45 ... 63	160	125	–	100	250		0.936	3.72
60 ... 80	200	160	–	100	250		0.615	3.94

Setting range from ... to A A	Short-circuit protection (fuses, circuit-breakers) Coordination type 2 (1)		Coordination type 1 (1)		Resistance per phase mΩ	Power loss per phase at upper current setting W
	gG A	aM A	gG A			

Thermal overload relay TA 110 DU

65 ... 90	200	160	250	0.540	4.37
80 ... 110	224	200	315	0.378	4.57

Thermal overload relay TA 200 DU

100 ... 135	224	200	315	0.318	5.79
110 ... 150	250	224	355	0.255	5.74
130 ... 175	315	250	400	0.214	6.55
150 ... 200	315	250	500	0.182	7.28

Thermal overload relay TA 450 SU

40 ... 60	125	100	not applicable to overload relays with current transformer	–	2.2
55 ... 80	160	125		–	2.2
70 ... 105	200	160		–	2.2
95 ... 140	315	250		–	2.2

Thermal overload relay TA 450 DU/SU

130 ... 185	355	250	not applicable to overload relays with current transformer	–	2.2
165 ... 235	400	315		–	2.2
220 ... 310	500	400		–	2.2

(1) Coordination type 1 and 2, see "Terms and Technical Definitions".

5

Thermal overload relays T... and TA...

Technical data



TA 25 DU

SB 7386

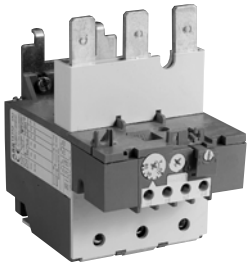

TA 110 DU

SB 7388

Load rating of auxiliary contacts

O/L relay type		T7 DU		TA25 DU ...TA450 DU/SU	
		NC 95 - 96	NO 97-98	NC 95 - 96	NO 97 - 98
Auxiliary contacts					
Rated operating voltage U_e	V	500	500	500	
Rated thermal current I_{th}	A	6	6	10	6
Rated operating current I_e					
at AC 15 to 240 V	A	1.5	1.5	3	1.5
at AC 15 to 440 V	A	0.7	0.5	1.9	0.95
at AC 15 to 500 V	A	0.5	0.3	1	0.75
at DC 13 to 24 V	A	-	-	1.25	0.42
to 60 V	A	-	-	0.50	0.17
to 120 V	A	-	-	0.25	0.08
to 250 V	A	0.2	0.02	0.12	0.04
Maximum potential difference between the NO and NC contacts	a.c. V	500		500	
	d.c. V	440		440	
Short-circuit protection fuse or:	gG A	4	4	10	6
STOTZ circuit-breaker type:					
S 271	A	K1	K1	K3	K1
S 281	A	K1	K1	K3	K1

Function of the thermal overload relays TA 25 DU ... TA 450 DU/SU

Press blue button	Contacts	Relay tripped		Relay not tripped	
		Manual	Automatic	Manual	Automatic
	NC 95-96 NO 97-98	open closed	open closed	closed open	closed open
Button R		Reset	-	-	-
	NC 95-96	closes when Button's pressed	-	-	-
	NO 97-98	opens when Button's pressed	-	-	-
Button R/O		Reset	-	-	-
	NC 95-96	closes when Button's released	-	opens when Button's pressed closes when Button's released	opens when Button's pressed closes when Button's released
	NO 97-98	opens when Button's pressed	-	-	-

Position of the connection terminals

TA 25 DU, TA 42 DU,
TA 75 DU, TA 80 DU

TA 200 DU

TA 450 DU/SU

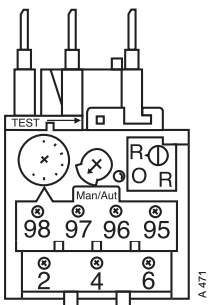

A 471

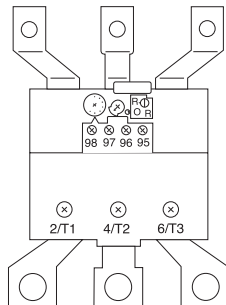

A 467

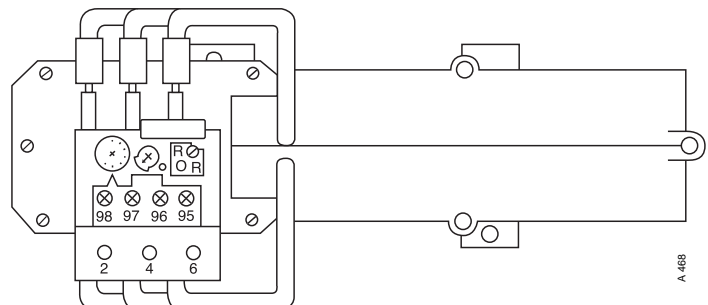

A 468

Thermal overload relays T 7 DU, TA 25 DU ... TA 200 DU, TA 450 DU/SU

Tripping curves

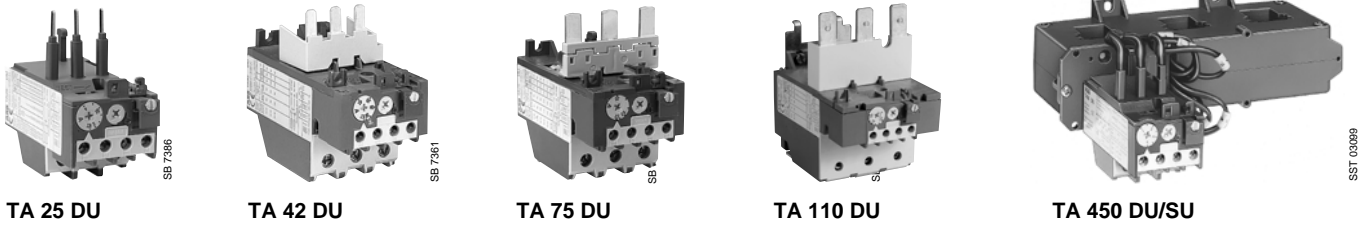

Thermal overload relays **T ... DU** are three-pole relays which can be converted from manual to automatic reset. The Reset button can also be used for disconnection. The built-in auxiliary contacts are electrically isolated and are therefore suitable for two different circuits (control circuit and signalling circuit). All relays feature a facility for temperature compensation and phase failure protection. The overload relays up to size TA 110 DU are safe from finger-touch and safe from touch by the back of the hand. Terminal shrouds are available for size TA 200 DU to TA 450 DU/SU. Connection terminals are delivered in open position, with Pozidriv cross-head screws (\pm) and screwdriver guide.

Tripping curves of the thermal overload relays (group curves)

T 7 DU

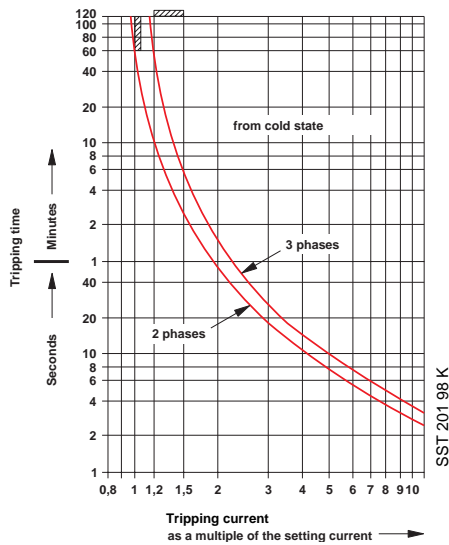

TA 25 DU

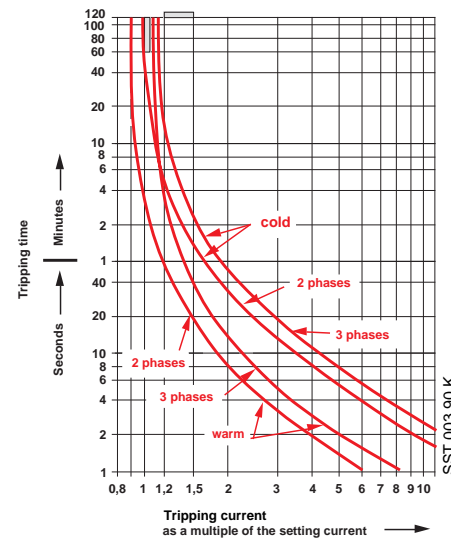

TA 42 DU / TA 75 DU / TA 80 DU

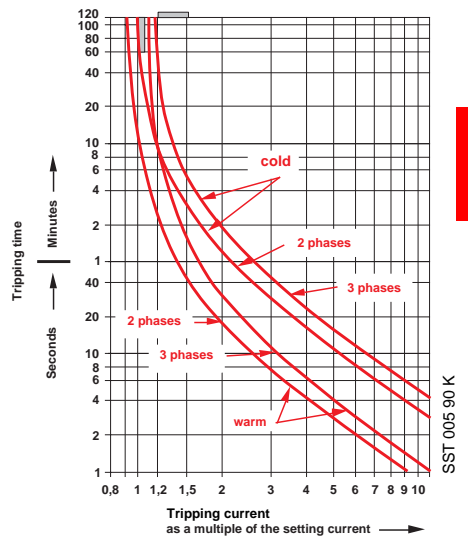

TA 200 DU

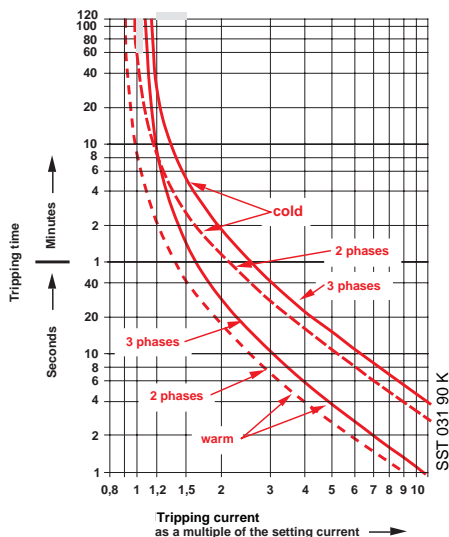

TA 450 DU

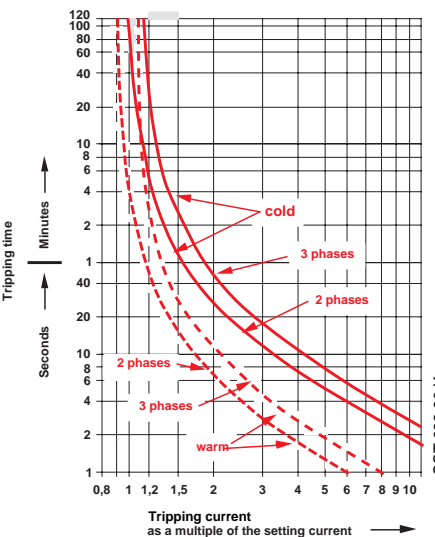

TA 450 SU

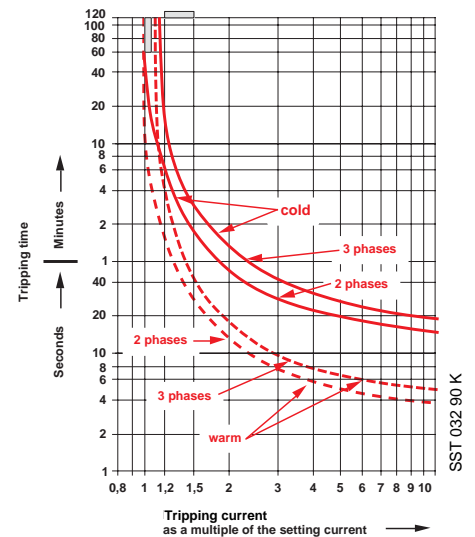

Thermal overload relays TA ..., V 1000 for ATEX motors

Selection table

Selection table for suitability of the overload relays for ATEX motors (PTB approvals).

Tripping times of the thermal overload relays as a function of a multiple of the setting current from cold state (tolerance $\pm 20\%$ of the tripping time).

Setting range of the thermal overload relays from ... to A A		Tripping times of the thermal overload relays at multiple of setting current:					
		3 s	4 s	5 s	6 s	7.2 s	8 s

Thermal overload relays TA 25 DU ... V 1000 (ATEX)

0.1 ... 0.16	17.3	10	7	5.6	4.5	4
0.16 ... 0.25	16.8	10	7.2	6	4.7	4.3
0.25 ... 0.4	16.3	10	7	5.6	4.4	3.9
0.4 ... 0.63	17.3	10.3	7.1	5.7	4.5	4
0.63 ... 1.0	20	12.6	8.4	6.7	5.3	4.5
1.0 ... 1.4	18.3	11.2	8	6.3	5	4.6
1.3 ... 1.8	18.8	11.1	7.5	6	4.7	4.2
1.7 ... 2.4	19.6	11.5	8	6	4.9	4.5
2.2 ... 3.1	18.3	10.5	7.6	6	4.7	4.2
2.8 ... 4.0	18.8	11.2	8	6.1	4.7	4.2
3.5 ... 5.0	17.8	10.9	7.7	6	4.5	4.1
4.5 ... 6.5	17.8	10.5	7.5	5.6	4.6	4
6.0 ... 8.5	17.8	10.9	7.7	6.1	5	4.5
7.5 ... 11	18.8	11.5	8.3	6.5	5.1	4.5
10 ... 14	17.8	10.9	7.7	6	4.7	4.2
13 ... 19	20.5	11.9	8.8	6	4.7	4
18 ... 25	22.4	13.3	8	6.8	5	4.5
24 ... 32	23.7	14	10	7.7	6	5.3

Thermal overload relays TA 42 DU, TA 75 DU, TA 80 DU ... V 1000 (ATEX)

18 ... 25	41	23.2	16	11.8	9	7.5
22 ... 32	37	21	13.8	10.6	8	6.8
29 ... 42	34	18.5	12.6	9.5	6.8	6
36 ... 52	43	23.9	16.1	11.8	9	7.3
45 ... 63	37.4	21.3	15.2	10.6	7.6	6.6
60 ... 80	46.7	23	15.7	11.5	7.9	6.7

Thermal overload relays TA ..., V 1000 for ATEX motors

Selection table

Thermal overload relays TA 110 DU ... V 1000 (ATEX)

66 ... 90	32	16.7	11.5	8.5	6.3	5.4
80 ... 110	34.5	18.2	12.2	8.8	6.7	5.1

Thermal overload relays TA 200 DU ... V 1000 (ATEX)

66 ... 90	27.7	15.8	10.6	7.9	5.6	4.9
80 ... 110	25.1	14.1	9.7	7.1	5.2	4.5
100 ... 135	24.4	13.3	8.9	6.3	4.6	4
110 ... 150	30	15.8	10.6	7.5	5.6	4.6
130 ... 175	30.1	15.8	11.0	7.5	5.6	5.0
150 ... 200	42.2	21.8	14.5	10.3	7.3	6

Thermal overload relays TA 450 DU ... V 1000 (ATEX)

130 ... 185	14.9	8.9	7.1	5.6	4.5	4.2
165 ... 235	18	10	7.1	5.5	4	3.8
220 ... 310	16.8	10	7.1	5.7	4.7	4

Electronic overload relay E 16 DU for contactors and mini contactors

Technical data

General technical data

Type		E 16 DU	
Standards: (major European and international standards)		IEC 60947-4-1 / IEC 60947-5-1 EN 60947-4-1 / EN 60947-5-1	
Rated insulation voltage U_i	V	690	
Rated operating voltage U_e	V	690	
Impulse withstand voltage U_{imp}	kV	6	
Permissible ambient temperature	- Storage	°C - 25 to +70	
	- Operation	°C - 25 to +70	
Climatic resistance according to		IEC 60068-2-1, IEC 60068-2-2, IEC 60068-2-14, IEC 60068-2-30	
Mounting position		any	
Resistance to shock	Shock duration ms	11	
	multiple of g	15	
Resistance to vibrations (±1 mm, 10 ... 100 Hz)	multiple of g	-	
		5	
Mounting	- onto contactor	Clipped beneath the contactor, fixed by screws on its main terminals	
	- with DB.. mounting kit for single set-ups	By screws: 2 x M4 or	
Connection terminals and attachment type			
Main conductors (load side)/and auxiliary contacts.			
• Screw terminal (screw size)		M3.5	
- with self-disengaging clamping piece		-	
- with terminal block		-	
- with busbars or cable lugs		-	
• Tightening torque	Nm	1	
• Connection cross-sections			
- single-core or stranded		2 x 0.75...4	
- flexible with wire end ferrule		2 x 0.75...4	
Protection degree to IEC 60947-1/EN 60947-1		All terminals are protected against access to hazardous parts with back hand and finger in acc. with EN 50274	

Technical data of the conducting paths

Type		E 16 DU	
Number of conducting paths		3	
Setting ranges		see "Ordering Details"	
Tripping classes to IEC 60947-4-1/EN 60947-4-1		see "Ordering Details"	
Frequency range	Hz	50 and 60	
Switching frequency without early tripping		80 cycles./h with 40% if the making current does not exceed 6 x I_n and the starting time does not exceed 1s.	
Resistance per phase in Ω and power loss per phase in W at max. setting current		see next pages	
Required fuses for short-circuit protection		see next pages	

Load rating of auxiliary contacts

Type		E 16 DU		
Contact		NC (95-96)	NO (97-98)	
Rated operating voltage U_e	V	600	600	
Rated thermal continuous current	A	6	6	
Rated operating current I_e	at AC-15 230 V	A	3	3
	at AC-15 400 V	A	1.1	1.1
	at AC-15 500 V	A	0.7	0.7
	at DC-13 24 V	A	1.5	1.5
	at DC-13 60 V	A	0.5	0.5
	at DC-13 110 V	A	0.4	0.4
	at DC-13 220 V	A	0.2	0.2
Short-circuit protection fuse or	gG	A	6	6
STOTZ safety circuit-breaker: S271, S281			(1)	(1)

(1) on request

>> Ordering Details page 5/24 >> Resistance per Phase page 5/38	>> Required Fuses page 5/38 >> Certification and Approvals section 7
--	---

Electronic overload relays E 200 DU ... E 1250 DU for contactors

Technical data

General technical data

Type	E 200 DU	E 320 DU	E 500 DU	E 800 DU	E 1250 DU
Standards: (major European and international standards)	IEC 60947-4-1 / IEC 60947-5-1 EN 60947-4-1 / EN 60947-5-1				
Rated insulation voltage U_i	V 690				
Rated operating voltage U_e	V 690				
Impulse withstand voltage U_{imp}	kV 6				
Permissible ambient temperature	- Storage °C -25 to +70 - Operation °C -25 to +70				
Climatic resistance according to	IEC 60068-2-1, IEC 60068-2-2, IEC 60068-2-14, IEC 60068-2-30		IEC 60068-2-1, IEC 60068-2-2, IEC 60068-2-30		
Mounting position	any				
Resistance to shock	Shock duration ms 30 multiple of g 5				—
Resistance to vibrations to IEC/EN 61373	category 1, class B				—
Mounting	- onto contactor Clipped beneath the contactor, fixed by screws on its main terminals - with DT.. mounting kit for single set-ups By screws: 2 x M4 or  - onto panel plate By screws: 4 x M5				—
Connection terminals and attachment type					
Auxiliary contacts.					
• Screw terminal (screw size) - with self-disengaging clamping piece	M3.5				
• Tightening torque	Nm 1				
• Connection cross-sections					
- single-core or stranded	mm ² 2 x 0.75...4				
- flexible with wire end ferrule	mm ² 2 x 0.75...4				
Connection terminals and attachment type					
Main conductors.					
• Screw terminal (screw size)	M8	M10	(M10)	(M12) <small>(rail order separately)</small>	(M12)
Protection degree to IEC 60947-1/EN 60947-1	All terminals are protected against access to hazardous parts with back hand and finger in acc. with EN 50274				IP 00 (Main terminals) (auxiliary circuits are protected)

Technical data of the conducting paths

Type	E 200 DU	E 320 DU	E 500 DU	E 800 DU	E 1250 DU
Number of conducting paths	3				
Setting ranges	A 60 ... 200	100 ... 320	150 ... 500	250 ... 800	375 ... 1250
Tripping classes to IEC 60947-4-1/EN 60947-4-1	10, 20, 30 eligible				
Frequency range	Hz 50 and 60 (only for a.c. operating 3 phase)				

Load rating of auxiliary contacts

Type	E 200 DU, E320 DU, E 500 DU, E 800 DU, E 1250 DU			
Contact	NC (95-96)		NO (97-98)	
Rated operating voltage U_e	V 600		600	
Rated thermal continuous current	A 6		6	
Rated operating current I_e	A		A	
at AC-15 230 V	3		3	
at AC-15 400 V	1.1		1.1	
at AC-15 500 V	0.7		0.7	
at DC-13 24 V	1.5		1.5	
at DC-13 60 V	0.5		0.5	
at DC-13 110 V	0.4		0.4	
at DC-13 220 V	0.2		0.2	
Short-circuit protection fuse	gG A 6		6	
or STOTZ safety circuit-breaker:	S271 (1)		S281 (1)	

(1) on request

Electronic overload relays E 16 DU ... E 1250 DU

Technical data

3-phase tripping curves for E ... DU electronic overload relay

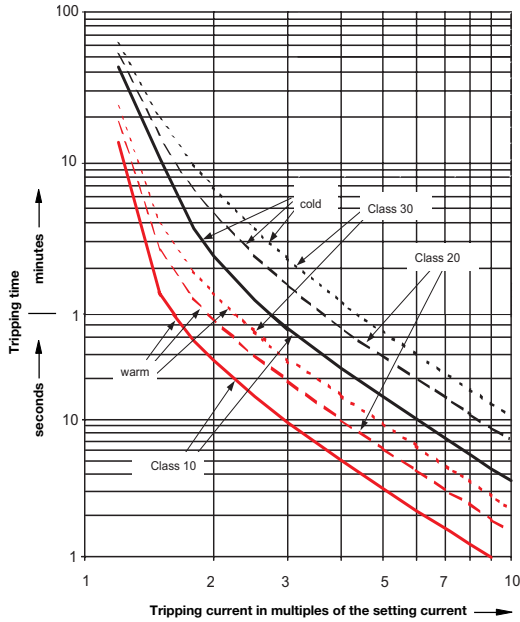

Tripping times from warm state

Multiples of rated motor current at start-up	Tripping time class 10 approx. [s]	Tripping time class 20 approx. [s]	Tripping time class 30 approx. [s]
3	8.6	17.2	25.9
4	4.5	9.1	13.5
5	2.8	5.6	8.5
6	1.9	3.9	5.8
7.2	1.4	2.6	3.9
8	1.1	2.2	3.3

Tripping times from cold state

Multiples of rated motor current at start-up	Tripping time class 10 approx. [s]	Tripping time class 20 approx. [s]	Tripping time class 30 approx. [s]
3	46.2	92.6	138.4
4	23.9	47.9	71.7
5	14.8	29.5	44.4
6	10.1	20.2	30.2
7.2	6.9	13.9	20.8
8	5.6	11.1	16.7

Note: E 16 DU ... E 1250 DU O/L relays are not suitable for single-phase and direct current (d.c.) motors!

Resistances and power losses

Setting range	Short-circuit protection (fuses, miniature circuit-breakers)	Resistance per phase at upper setting current mΩ	Power loss per phase W
A ... A	gG A		

Electronic overload relay E 16 DU

0.1 ... 0.32	1	970	0.1
0.3 ... 1.00	4	113	0.11
0.9 ... 2.70	10	14	0.1
2.0 ... 6.30	20	2.4	0.1
5.7 ... 18.90	50	0.8	0.29

Electronic overload relays E 200 DU ... E 1250 DU: on request

Electronic overload relays E 16 DU ... E 1250 DU

Technical data

Applications with frequent starts

In order to avoid overloads, motors must not be operated with just any starting frequency. With frequent start of motors the rated current of the motor doesn't play the decisive part anymore but much rather the higher starting current (typical 6 x the rated motor current) as well as the starting frequency, the start-up time and the power-on time. A periodical operation of the motor is exemplified in the current-/time-curve below:

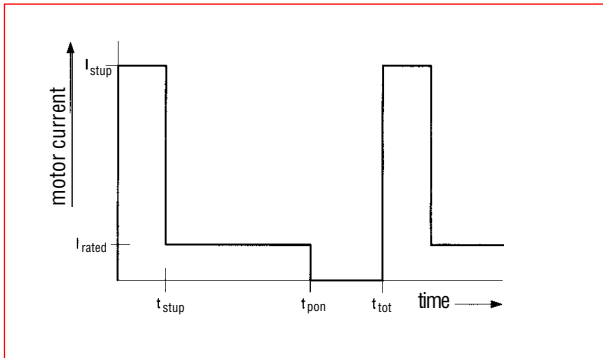

I_{stup} starting current of motor
 I_{rated} rated current of motor
 t_{stup} start-up time
 t_{pon} total power-on time
 t_{tot} cycle time

Sometimes calculations are done using the power-on time PT. The value of PT can be deducted as follows:

$$PT = \frac{t_{pon}}{t_{tot}}$$

The electronic overload relay simulates the thermal behaviour of a motor in a model. The tripping threshold of the overload relay is situated at $(1.125 \pm 0.075) \times$ rated current. The temperature of the motor can have the following characteristics, when it gets started frequently. As shown in this example the mean temperature of the motor stays beneath the permissible maximum temperature, however, on start-up the motor temperature can exceed this temperature barrier. In this case the overload relay trips.

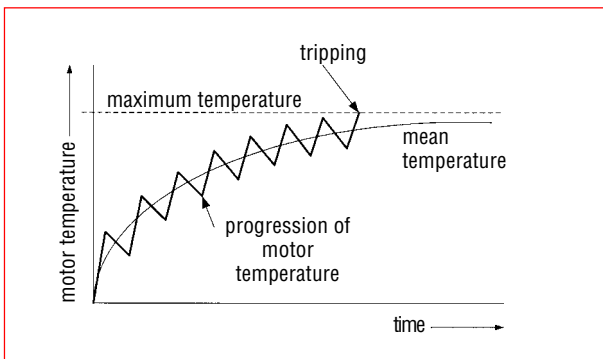

With each start-up, the motor will heat up immensely though for a short time period only (increase in the temperature characteristic of the motor). The heat will distribute itself throughout the motor once the start-up process is finished as well as in breaks when the motor is not running (decrease in the temperature characteristic of the motor). This way the mean temperature of the motor rises. The light curve shows the increase of the mean temperature. To prevent damage to the motor it has to be stopped if the temperature of the motor exceeds the maximum permissible temperature. In this case the overload relay trips.

The tripping curve of the overload relays gives an orientation for the permissible duration of a motor start-up for cases, when due to long power-on times (PT) or due to frequent starts the mean effective value of the current reaches the rated current. The mean effective value I_{eff} is calculated as follows:

$$I_{eff} = \sqrt{\frac{I_{stup}^2 \cdot t_{stup} + I_{rated}^2 \cdot (t_{pon} - t_{stup})}{t_{tot}}}$$

For overload relays E... the maximum start-up times can be deducted from the curve "warm" for $I_{eff} \leq I_{rated}$ as an orientation. The start-up times should be 10% under the tripping times of the curve (see table)

Coordination with Short-circuit Protection Devices

Switch-disconnector-fuses, Contactors and Overload Relays

A motor starter is typically made up of a switching device (contactor) and an overload protection device.

These two devices MUST be coordinated with an equipment capable of providing protection against short-circuit (SCPD: Short-Circuit Protection Device).

A complete data base of coordination tables, according to IEC 60947-4-1 (EN 60947-4-1), is available on the ABB Website: see www.abb.com/lowvoltage then go to the right menu: "Support", select: "Online Product Selection Tools".

Online Selected Optimized Coordination Tables

- [Introduction](#)
- [Instructions](#)
- [F.A.Q.](#)
- [Troubleshooting](#)



Short-Circuit Protection Device (SCPD) selection

Selection

[Switch-disconnector-fuses \(aM and gG\)](#)

Rated Output [kW]	Rated Current [A]	Motor Type	Switch-Fuse Type	Fuse Rating gG / aM [A]	Fuse Type and Size	Contactor Type	Overload Protection Device Type	Current setting range [A] 16 setting max for starter [s]	Max. Allowed Setting Current [A]
0.37	1.1	DS 32D_	4	OFAA00H	A8	TA25DU 1.4	1.0 - 1.4	1.4	
0.55	1.5	OS 32D_	6	OFAA00H	A8	TA25DU 1.8	1.3 - 1.8	1.8	
0.75	1.9	OS 32D_	6	OFAA00H	A8	TA25DU 2.4	1.7 - 2.4	2	
1.1	2.7	OS 32D_	10	OFAA00H	A8	TA25DU 3.1	2.2 - 3.1	3.1	
1.5	3.8	OS 32D_	10	OFAA00H	A8	TA25DU 5.0	3.5 - 5.0	5	
1.5	3.8	OS 32D_	10	OFAA00H	A8	TA25DU 4.0	2.8 - 4.0	3.7	
2.2	4.9	OS 32D_	16	OFAA00H	A8	TA25DU 6.5	4.5 - 6.5	6.5	
3	6.5	OS 32D_	20	OFAA00H	A8	TA25DU 8.5	6.0 - 8.5	8	
4	8.5	OS 32D_	25	OFAA00H	A8	TA25DU 11	7.5 - 11	9	
5.5	11.5	OS 32D_	32	OFAA00H	A12	TA25DU 14	10 - 14	12	
7.5	15.2	OS 32D_	32	OFAA00H	A16	TA25DU 19	13 - 19	16.5	
7.5	15.2	OS 32D_	40	OFAA00H	A26	TA25DU 19	13 - 19	17	
11	22	OS 32D_	63	OFAA00H	A26	TA25DU 25	18 - 25	25	
15	29	OS 32D_	80	OFAA00H	A30	TA25DU 32	24 - 32	32	
18.5	35	OS 63D_	100	OFAA00H	A40	TA42DU 42	29 - 42	37	
18.5	35	OS 63D_	100	OFAA00H	A60	TA75DU 42	29 - 42	40	
22	41	OS 125D_	125	OFAA00H	A60	TA75DU 52	36 - 52	50	
30	55	OS 125D_	125	OFAA00H	A63	TA75DU 63	45 - 63	60	
30	55	OS 250D_	180	OFAA11H	A63	TA75DU 63	45 - 63	63	
37	66	OS 250D_	200	OFAA11H	A65	TA80DU 80	60 - 80	80	
45	80	OS 250D_	200	OFAA11H	A65	TA110DU 90	65 - 90	90	
45	80	OS 250D_	250	OFAA11H	A146	TA200DU 90	65 - 90	90	

Protection against short-circuits and isolation with switch-disconnector-fuse
 Protection against overloads with O/L relay

Complete coordination tables are available for the **Short-Circuit Protection Device (SCPD)**, the **Contactor** and the **Overload Protection Device** according to the **Rated Operational Voltage U_e** , the **Rated Short-circuit Current I_q** , the **Coordination Type** (type 1 or 2) and the **Motor Power**.

www.abb.com/lowvoltage **Online Selected Optimized Coordination Tables**

>> For Further Information see Section 7

Notes

