

An aerial view of a city, likely San Francisco, with a prominent blue skyscraper (Salesforce Tower) in the center. The city is overlaid with a complex network of glowing blue lines and nodes, representing a digital or smart city infrastructure. The sky is blue with white clouds, and mountains are visible in the background.

SIEMENS

Ingenuity for life

Our commitment is
your safe future

Electrical Installations from A to Z

Price List w.e.f. 1st March, 2020

Experience active communication

Face the reality of remote monitoring & controlling of our Final distribution products. Yes, our MCBs & RCDs can now speak and obey your commands! The Siemens solution for remote communication capability facilitates the following applications, which are inevitable in today's smart infrastructures like Data centers, Commercial Buildings, Energy Management Systems etc.

The solution covers:

- Remote controlling (ON/OFF) of Final distribution products i.e. MCBs, RCDs via. RC unit
- ON/OFF status monitoring of all modules of Final distribution products via Auxiliary switch
- Fault Trip Status of Final distribution level via Fault signaling contact

Note: for more information refer page no. 18

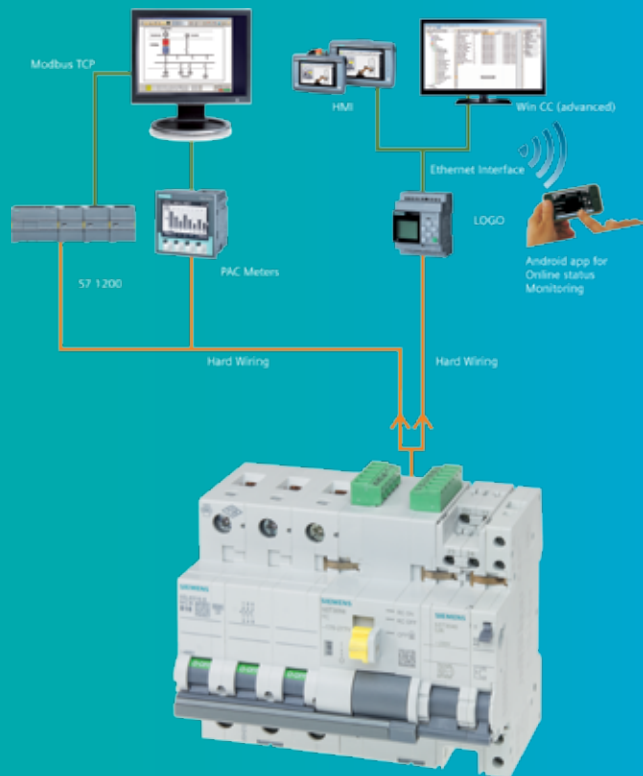

5ST3 remote mechanism – ON/OFF switching remotely and safely



Comprehensive range of products for any application – from wind turbine controls to lighting control in tunnels



Direct and immediate access to the installation even in hard-to-access locations



Cost and time savings thanks to quick restart after a fault

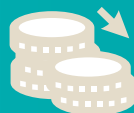



Sr. No.	Items	Pg. No.
1	Betagard Miniature Circuit Breakers	
	5SL6, 7.5kA with C characteristics	5
	5SL6, 7.5kA with B characteristics	6
	5SL4, 10kA with C characteristics	7
	5SL7, with C characteristics	8
	5SL7, with D characteristics	9
	5SY4, 10kA CBs with C characteristics	10
	5SP4, 10kA with C and D characteristics	10
2	Betagard Circuit Breakers	
	5SL5, 10kA DC with C characteristics	11
3	Betagard Isolators	
	5TL1 Isolators	11
4	Betagard Residual Current Circuit Breakers	
	5SV RCCB - Type AC, Type A	14
	5SM3 RCCB - Type AC, Type A	15
5	Betagard Residual Current Breaker Operators	
	5SU1 RCBO, 10kA, Type AC with C and D characteristics	16
	5SU1 RCBO, 10kA, Type A with C and D characteristics	17
6	Betagard Accessories NEW	18
7	SIRENEW	19
8	SIARC	20-21
9	Arc Fault Detection Devices (AFDD) NEW	22-23
10	Betagard Distribution Boards	
	8GB32 SPN, TPN & Phase Segregated DBs	25-27
	8GB0 SPN & TPN DBs	28
	8GB31 - Flexi, Bus, Bus Plus, Multi, CO DBs	29
	Wire Way Boxes & Modular Device Boxes	30
	Industrial Plug & Socket DBs, Simbox WP DBs	30
	Accessories for Betagard DBs	31
11	Sentron Surge Protection Devices NEW	
	Surge Protection Devices	32-35
12	Sentron Modular Devices	
	Changeover switches, Insta contactors	37
	Twilight switch, Voltage relays, Indicators and Fuse monitors	38
	Time switches	39
13	Sentron MCCBs -3VM, 3VT1..3 and RAJA+ Starters ordering info	40-41
14	Switch Disconnecter Fuses - 3KL and Fuses - 3NA/3NW ordering info	42
15	Available till stocks last	43-44
16	Discontinued products	45
17	Multi channel current measuring system	46-47
18	Technical Information	48-49
19	Customer Care	50

Betagard 5SL MCBs – Inspiring Safety

Siemens has always endeavoured to introduce innovative products worldwide.

Betagard 5SL MCBs offer numerous features -

- MCB with patented unique SLR feature
- ISI and CE marking
- Unique square terminal design
- Terminal covers for extra protection
- RoHS compliant
- Accessories for special applications
- Very low watt loss
- 20,000 operations on rated load



MCB with patented unique **SLR** (Slide Latch-Release) feature for tool free removal from DIN rail. It also allows individual MCB to be removed from bus bar mounted assembly without disturbing other devices

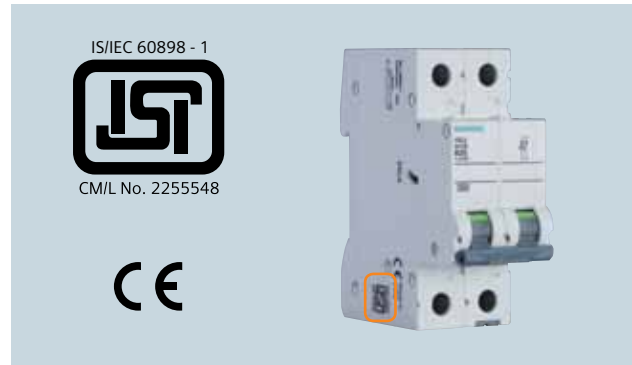

BIS approval for ISI marking as per latest IS/IEC 60898-1:2002 for assured quality and protection



Unique design of square terminals of 35 Sq. mm

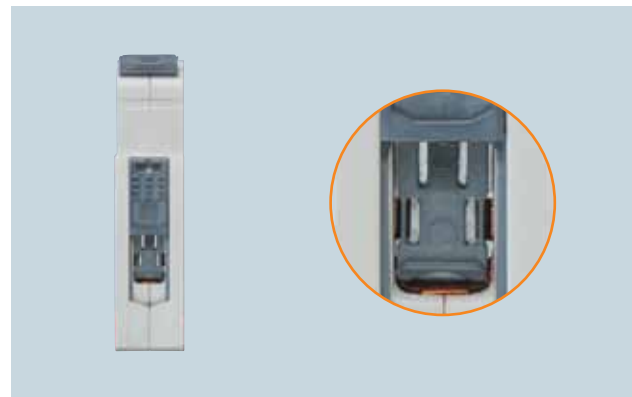

Highly effective terminal covers for protection against accidental electrical contact

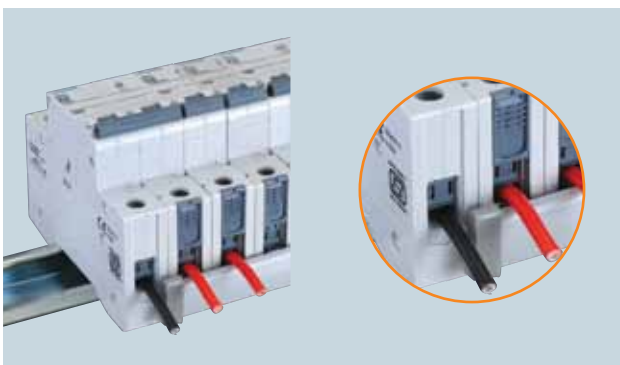





Unique termination mechanism enables firm mounting of Bus bar together with wire; and provides front access to wires for safe installation



Side mounting accessories like auxiliary switches, fault signaling contacts and lever locking device available for special applications

Betagard Miniature Circuit Breakers 5SL6, with C Characteristics

- Standards: IS/IEC 60898-1:2002
- Voltage: Un 240/415V, 50...60Hz[^]
- With ISI marking: CM/L No. 2255548

7500A	Rated Current I_n (A)	MW [#]	Reference No	Unit MRP* ₹	Std. Pkg. ** (Nos.)	
	1P, 240/415V AC	1	5SL61057RC	381.-	1/12	
	0.5	1	5SL61017RC	381.-	1/12	
	1	1	5SL61027RC	381.-	1/12	
	2	1	5SL61037RC	381.-	1/12	
	3	1	5SL61047RC	381.-	1/12	
	4	1	5SL61067RC	235.-	1/12	
	6	1	5SL61087RC	235.-	1/12	
	8	1	5SL61107RC	235.-	1/12	
	10	1	5SL61137RC	235.-	1/12	
	13	1	5SL61167RC	235.-	1/12	
	16	1	5SL61207RC	235.-	1/12	
	20	1	5SL61257RC	235.-	1/12	
	25	1	5SL61327RC	235.-	1/12	
	32	1	5SL61407RC	514.-	1/12	
	40	1	5SL61507RC	597.-	1/12	
	50	1	5SL61637RC	597.-	1/12	
	2P, 415V AC	2	5SL62057RC	1017.-	1/6	
	0.5	2	5SL62017RC	1017.-	1/6	
	1	2	5SL62027RC	1017.-	1/6	
	2	2	5SL62037RC	1017.-	1/6	
	3	2	5SL62047RC	1017.-	1/6	
	4	2	5SL62067RC	761.-	1/6	
	6	2	5SL62087RC	761.-	1/6	
	8	2	5SL62107RC	761.-	1/6	
	10	2	5SL62137RC	761.-	1/6	
	13	2	5SL62167RC	761.-	1/6	
	16	2	5SL62207RC	761.-	1/6	
	20	2	5SL62257RC	761.-	1/6	
	25	2	5SL62327RC	761.-	1/6	
	32	2	5SL62407RC	1049.-	1/6	
	40	2	5SL62507RC	1243.-	1/6	
	50	2	5SL62637RC	1243.-	1/6	
	3P, 415V AC	3	5SL63057RC	1428.-	1/4	
	0.5	3	5SL63017RC	1428.-	1/4	
	1	3	5SL63027RC	1428.-	1/4	
	2	3	5SL63047RC	1428.-	1/4	
	4	3	5SL63067RC	1133.-	1/4	
	6	3	5SL63107RC	1133.-	1/4	
	10	3	5SL63167RC	1133.-	1/4	
	16	3	5SL63207RC	1133.-	1/4	
	20	3	5SL63257RC	1133.-	1/4	
	25	3	5SL63327RC	1133.-	1/4	
	32	3	5SL63407RC	1586.-	1/4	
	40	3	5SL63507RC	1771.-	1/4	
	50	3	5SL63637RC	1771.-	1/4	
	63	3				
		4P, 415V AC	4	5SL64057RC	1971.-	1/3
		0.5	4	5SL64017RC	1971.-	1/3
1		4	5SL64027RC	1971.-	1/3	
2		4	5SL64047RC	1971.-	1/3	
4		4	5SL64067RC	1567.-	1/3	
6		4	5SL64107RC	1567.-	1/3	
10		4	5SL64167RC	1567.-	1/3	
16		4	5SL64207RC	1567.-	1/3	
20		4	5SL64257RC	1567.-	1/3	
25		4	5SL64327RC	1567.-	1/3	
32		4	5SL64407RC	2043.-	1/3	
40		4	5SL64507RC	2344.-	1/3	
50		4	5SL64637RC	2344.-	1/3	
63		4				

■ Stock items

Note:

* MRP - Maximum Retail Price





1MW (Module Width) = 18mm

** Purchase MOQ for our authorised dealers is in multiples of standard packing, contact Siemens Sales Office for further details

^ Suitable for DC networks in Telecom application; 60V DC for 1P & 110V DC for 2P (contact sales office for connection diagram)

Betagard Miniature Circuit Breakers 5SL6, with B Characteristics

- Standards: IS/IEC 60898-1:2002
- Voltage: Un 240/415V, 50...60Hz
- With ISI marking: CM/L No. 2255548

7500A	Rated Current I_n (A)	MW#	Reference No	Unit MRP* ₹	Std. Pkg.** (Nos.)
1P, 240/415V AC 	6	1	5SL61066RC	230.-	1/12
	10		5SL61106RC	230.-	1/12
	16		5SL61166RC	230.-	1/12
	20		5SL61206RC	230.-	1/12
	25		5SL61256RC	230.-	1/12
	32		5SL61326RC	230.-	1/12
	40		5SL61406RC	512.-	1/12
	50		5SL61506RC	575.-	1/12
	63		5SL61636RC	575.-	1/12
2P, 415V AC 	6	2	5SL62066RC	745.-	1/6
	10		5SL62106RC	745.-	1/6
	16		5SL62166RC	745.-	1/6
	20		5SL62206RC	745.-	1/6
	25		5SL62256RC	745.-	1/6
	32		5SL62326RC	745.-	1/6
	40		5SL62406RC	1049.-	1/6
	50		5SL62506RC	1233.-	1/6
	63		5SL62636RC	1233.-	1/6
3P, 415V AC 	6	3	5SL63066RC	1133.-	1/4
	10		5SL63106RC	1133.-	1/4
	16		5SL63166RC	1133.-	1/4
	20		5SL63206RC	1133.-	1/4
	25		5SL63256RC	1133.-	1/4
	32		5SL63326RC	1133.-	1/4
	40		5SL63406RC	1565.-	1/4
	50		5SL63506RC	1756.-	1/4
	63		5SL63636RC	1756.-	1/4
4P, 415V AC 	6	4	5SL64066RC	1558.-	1/3
	10		5SL64106RC	1558.-	1/3
	16		5SL64166RC	1558.-	1/3
	20		5SL64206RC	1558.-	1/3
	25		5SL64256RC	1558.-	1/3
	32		5SL64326RC	1558.-	1/3
	40		5SL64406RC	1944.-	1/3
	50		5SL64506RC	2337.-	1/3
	63		5SL64636RC	2337.-	1/3

■ Stock items

Note:

* MRP - Maximum Retail Price # 1MW (Module Width) = 18mm





** Purchase MOQ for our authorised dealers is in multiples of standard packing, contact Siemens Sales Office for further details



Betagard Miniature Circuit Breakers

5SL4, with C characteristics

- Standards: IS/IEC 60898-1:2002
- Voltage: Un 240/415V, 50...60Hz[^]
- Breaking capacity: 10kA as per IS/IEC 60898-1:2002
- With ISI marking: CM/L No. 2255548

10000A	Rated Current I_n (A)	MW#	Reference No	Unit MRP* ₹	Std. Pkg.** (Nos.)	
	1P, 240/415V AC	0.5	1	5SL41057RC	441.-	1/12
	2	2	5SL41027RC	441.-	1/12	
	3	3	5SL41037RC	441.-	1/12	
	4	4	5SL41047RC	441.-	1/12	
	6	6	5SL41067RC	286.-	1/12	
	8	8	5SL41087RC	286.-	1/12	
	10	10	5SL41107RC	286.-	1/12	
	13	13	5SL41137RC	286.-	1/12	
	16	16	5SL41167RC	286.-	1/12	
	20	20	5SL41207RC	286.-	1/12	
	25	25	5SL41257RC	286.-	1/12	
	32	32	5SL41327RC	286.-	1/12	
	40	40	5SL41407RC	623.-	1/12	
	50	50	5SL41507RC	623.-	1/12	
63	63	5SL41637RC	623.-	1/12		
	2P, 415V AC	0.5	2	5SL42057RC	1182.-	1/6
	2	2	5SL42027RC	1182.-	1/6	
	3	3	5SL42037RC	1182.-	1/6	
	4	4	5SL42047RC	1182.-	1/6	
	6	6	5SL42067RC	847.-	1/6	
	8	8	5SL42087RC	847.-	1/6	
	10	10	5SL42107RC	847.-	1/6	
	13	13	5SL42137RC	847.-	1/6	
	16	16	5SL42167RC	847.-	1/6	
	20	20	5SL42207RC	847.-	1/6	
	25	25	5SL42257RC	847.-	1/6	
	32	32	5SL42327RC	847.-	1/6	
	40	40	5SL42407RC	1367.-	1/6	
	50	50	5SL42507RC	1367.-	1/6	
63	63	5SL42637RC	1367.-	1/6		
	3P, 415V AC	0.5	3	5SL43057RC	1909.-	1/4
	2	2	5SL43027RC	1909.-	1/4	
	3	3	5SL43037RC	1909.-	1/4	
	4	4	5SL43047RC	1909.-	1/4	
	6	6	5SL43067RC	1423.-	1/4	
	8	8	5SL43087RC	1423.-	1/4	
	10	10	5SL43107RC	1423.-	1/4	
	13	13	5SL43137RC	1423.-	1/4	
	16	16	5SL43167RC	1423.-	1/4	
	20	20	5SL43207RC	1423.-	1/4	
	25	25	5SL43257RC	1423.-	1/4	
	32	32	5SL43327RC	1423.-	1/4	
	40	40	5SL43407RC	2153.-	1/4	
	50	50	5SL43507RC	2153.-	1/4	
63	63	5SL43637RC	2153.-	1/4		
	4P, 415V AC	0.5	4	5SL44057RC	2402.-	1/3
	2	2	5SL44027RC	2402.-	1/3	
	3	3	5SL44037RC	2402.-	1/3	
	4	4	5SL44047RC	2402.-	1/3	
	6	6	5SL44067RC	1971.-	1/3	
	8	8	5SL44087RC	1971.-	1/3	
	10	10	5SL44107RC	1971.-	1/3	
	13	13	5SL44137RC	1971.-	1/3	
	16	16	5SL44167RC	1971.-	1/3	
	20	20	5SL44207RC	1971.-	1/3	
	25	25	5SL44257RC	1971.-	1/3	
	32	32	5SL44327RC	1971.-	1/3	
	40	40	5SL44407RC	2688.-	1/3	
	50	50	5SL44507RC	2688.-	1/3	
63	63	5SL44637RC	2688.-	1/3		

■ Stock items

Note: * MRP - Maximum Retail Price # 1MW (Module Width) = 18mm

** Purchase MOQ for our authorised dealers is in multiples of standard packing, contact Siemens Sales Office for further details

^ Suitable for DC networks in Telecom application; 60V DC for 1P & 110V DC for 2P (contact sales office for connection diagram)

Betagard Miniature Circuit Breakers 5SL7, with C characteristics



- Standards: IS/IEC 60898-1
- Voltage: Un 240/415V, 50....60Hz
- Breaking capacity: 15kA¹⁾ as per IS/IEC 60898-1

	Rated Current I_n (A)	MW#	Reference No	Unit MRP* ₹	Std. Pkg.** (Nos.)
1P, 240/415V AC 	2	1	5SL71027RC	495.-	1/12
	4		5SL71047RC	495.-	1/12
	6		5SL71067RC	425.-	1/12
	10		5SL71107RC	425.-	1/12
	16		5SL71167RC	425.-	1/12
	20		5SL71207RC	425.-	1/12
	25		5SL71257RC	425.-	1/12
	32		5SL71327RC	425.-	1/12
	40		5SL71407RC	635.-	1/12
	50		5SL71507RC	635.-	1/12
63	5SL71637RC	635.-	1/12		
2P, 415V AC 	2	2	5SL72027RC	1335.-	1/6
	4		5SL72047RC	1335.-	1/6
	6		5SL72067RC	970.-	1/6
	10		5SL72107RC	970.-	1/6
	16		5SL72167RC	970.-	1/6
	20		5SL72207RC	970.-	1/6
	25		5SL72257RC	970.-	1/6
	32		5SL72327RC	970.-	1/6
	40		5SL72407RC	1380.-	1/6
	50		5SL72507RC	1380.-	1/6
63	5SL72637RC	1380.-	1/6		
3P, 415V AC 	2	3	5SL73027RC	2045.-	1/4
	4		5SL73047RC	2045.-	1/4
	6		5SL73067RC	1540.-	1/4
	10		5SL73107RC	1540.-	1/4
	16		5SL73167RC	1540.-	1/4
	20		5SL73207RC	1540.-	1/4
	25		5SL73257RC	1540.-	1/4
	32		5SL73327RC	1540.-	1/4
	40		5SL73407RC	2235.-	1/4
	50		5SL73507RC	2235.-	1/4
63	5SL73637RC	2235.-	1/4		
4P, 415V AC 	2	4	5SL74027RC	2580.-	1/3
	4		5SL74047RC	2380.-	1/3
	6		5SL74067RC	2005.-	1/3
	10		5SL74107RC	2005.-	1/3
	16		5SL74167RC	2005.-	1/3
	20		5SL74207RC	2005.-	1/3
	25		5SL74257RC	2005.-	1/3
	32		5SL74327RC	2005.-	1/3
	40		5SL74407RC	2730.-	1/3
	50		5SL74507RC	2730.-	1/3
63	5SL74637RC	2730.-	1/3		

Note:

* MRP - Maximum Retail Price # 1MW (Module Width) = 18mm

** Purchase MOQ for our authorised dealers is in multiples of standard packing, contact Siemens Sales Office for further details

1) Refer catalog for rating wise breaking capacities

Betagard Miniature Circuit Breakers 5SL7, with D characteristics

IS/IEC 60898 - 1



CML No. 2255548

- Standards: IS/IEC 60898-1
- Voltage: Un 240/415V, 50....60Hz
- Breaking capacity: 15kA¹⁾ as per IS/IEC 60898-1

	Rated Current I_n (A)	MW [#]	Reference No	Unit MRP* ₹	Std. Pkg. ** (Nos.)
1P, 240/415V AC 	2	1	5SL71028RC	495.-	1/12
	4		5SL71048RC	495.-	1/12
	6		5SL71068RC	445.-	1/12
	10		5SL71108RC	445.-	1/12
	16		5SL71168RC	445.-	1/12
	20		5SL71208RC	445.-	1/12
	25		5SL71258RC	445.-	1/12
	32		5SL71328RC	445.-	1/12
	40		5SL71408RC	840.-	1/12
	50		5SL71508RC	840.-	1/12
63	5SL71638RC	840.-	1/12		
2P, 415V AC 	2	2	5SL72028RC	1335.-	1/6
	4		5SL72048RC	1335.-	1/6
	6		5SL72068RC	1020.-	1/6
	10		5SL72108RC	1020.-	1/6
	16		5SL72168RC	1020.-	1/6
	20		5SL72208RC	1020.-	1/6
	25		5SL72258RC	1020.-	1/6
	32		5SL72328RC	1020.-	1/6
	40		5SL72408RC	1835.-	1/6
	50		5SL72508RC	1835.-	1/6
63	5SL72638RC	1835.-	1/6		
3P, 415V AC 	2	3	5SL73028RC	2045.-	1/4
	4		5SL73048RC	2045.-	1/4
	6		5SL73068RC	1620.-	1/4
	10		5SL73108RC	1620.-	1/4
	16		5SL73168RC	1620.-	1/4
	20		5SL73208RC	1620.-	1/4
	25		5SL73258RC	1620.-	1/4
	32		5SL73328RC	1620.-	1/4
	40		5SL73408RC	2860.-	1/4
	50		5SL73508RC	2860.-	1/4
63	5SL73638RC	2860.-	1/4		
4P, 415V AC 	2	4	5SL74028RC	2620.-	1/3
	4		5SL74048RC	2620.-	1/3
	6		5SL74068RC	2140.-	1/3
	10		5SL74108RC	2140.-	1/3
	16		5SL74168RC	2140.-	1/3
	20		5SL74208RC	2140.-	1/3
	25		5SL74258RC	2140.-	1/3
	32		5SL74328RC	2140.-	1/3
	40		5SL74408RC	3590.-	1/3
	50		5SL74508RC	3590.-	1/3
63	5SL74638RC	3590.-	1/3		

Note:

* MRP - Maximum Retail Price # 1MW (Module Width) = 18mm

** Purchase MOQ for our authorised dealers is in multiples of standard packing, contact Siemens Sales Office for further details

1) Refer catalog for rating wise breaking capacities

Miniature Circuit Breakers

Betagard Miniature Circuit Breakers 5SY4, with C characteristics

- Standards: IEC/EN 60947-2
- Voltage: Un 230/400V
- Breaking capacity: 10kA as per IEC/EN 60947-2

C characteristic





10000A		Rated Current I _n (A)	MW#	Reference No	Unit MRP* ₹	Std. Pkg.** (Nos.)
	1Pole	80A	1	5SY41807CC	2995.-	1/1
	2Pole		2	5SY42807CC	5885.-	1/1
	3Pole		3	5SY43807CC	9190.-	1/1
	4Pole		4	5SY44807CC	13170.-	1/1

Betagard Miniature Circuit Breakers 5SP4, with C/D characteristics







- Standards: IS/IEC 60898-1:2002
- Voltage: Un 240/415V
- Breaking capacity: 10kA as per IS/IEC 60898-1:2002
- With ISI marking: CM/L No. 2255548

C characteristic

10000A		Rated Current I _n (A)	MW#	Reference No	Unit MRP* ₹	Std. Pkg.** (Nos.)
	1-pole	80	1.5	5SP41807RC	2940.-	1/10
		100		5SP41917RC	3100.-	1/10
		125		5SP41927RC	3520.-	1/10
	2-pole	80	3	5SP42807RC	5775.-	1/5
		100		5SP42917RC	6090.-	1/5
		125		5SP42927RC	6890.-	1/5
	3-pole	80	4.5	5SP43807RC	9015.-	1
		100		5SP43917RC	9250.-	1
		125		5SP43927RC	10600.-	1
	4-pole	80	6	5SP44807RC	12925.-	1
		100		5SP44917RC	13300.-	1
		125		5SP44927RC	15140.-	1

D characteristic

	1-pole	80	1.5	5SP41808RC	3240.-	1/10
		100		5SP41918RC	3395.-	1/10
	2-pole	80	3	5SP42808RC	6500.-	1/5
		100		5SP42918RC	6895.-	1/5
	3-pole	80	4.5	5SP43808RC	10015.-	1
		100		5SP43918RC	10110.-	1
	4-pole	80	6	5SP44808RC	14085.-	1
		100		5SP44918RC	14440.-	1



Note:

* MRP - Maximum Retail Price # 1MW (Module Width) = 18mm

** Purchase MOQ for our authorised dealers is in multiples of standard packing, contact Siemens Sales Office for further details

Betagard Circuit Breakers 5SL5, DC with C Characteristics

- Standards: IS/IEC 60947-2
- Voltage: 220V DC/1P & 440VDC/2P ^
- Breaking capacity: 10kA as per IS/IEC 60947-2

10000A	Rated Current I_n (A)	MW#	Reference No	Unit MRP* ₹	Std. Pkg.** (Nos.)
	0.5	1	5SL51057RC	731.-	1/12
	1		5SL51017RC	731.-	1/12
	2		5SL51027RC	788.-	1/12
	4		5SL51047RC	788.-	1/12
	6		5SL51067RC	670.-	1/12
	10		5SL51107RC	670.-	1/12
	16		5SL51167RC	670.-	1/12
	20		5SL51207RC	670.-	1/12
	25		5SL51257RC	670.-	1/12
	32		5SL51327RC	670.-	1/12
	40		5SL51407RC	999.-	1/12
	50		5SL51507RC	999.-	1/12
	63		5SL51637RC	999.-	1/12
	0.5	2	5SL52057RC	1591.-	1/6
	1		5SL52017RC	1591.-	1/6
	2		5SL52027RC	1591.-	1/6
	4		5SL52047RC	1591.-	1/6
	6		5SL52067RC	1396.-	1/6
	10		5SL52107RC	1396.-	1/6
	16		5SL52167RC	1396.-	1/6
	20		5SL52207RC	1396.-	1/6
	25		5SL52257RC	1396.-	1/6
	32		5SL52327RC	1396.-	1/6
	40		5SL52407RC	2060.-	1/6
	50		5SL52507RC	2060.-	1/6
	63		5SL52637RC	2060.-	1/6



■ Stock items

^ For connection diagram, contact Siemens Sales Office for further details.

• Also available DC Circuit Breakers for Solar applications - contact Siemens sales office for further details.

Betagard Isolators 5TL1

- Standard: IS/IEC 60947-3
- Voltage: 440V AC

	Rated Current I_n (A)	MW#	Reference No	Unit MRP* ₹	Std. Pkg.** (Nos.)
	32	2	5TL12320	580.-	1/1
	40		5TL12400	595.-	1/1
	63		5TL12630	785.-	1/1
	80		5TL12800	1030.-	1/1
	100		5TL12910	1310.-	1/1
	125		5TL12920	1360.-	1/1
	32	3	5TL13320	960.-	1/1
	40		5TL13400	1115.-	1/1
	63		5TL13630	1240.-	1/1
	80		5TL13800	1505.-	1/1
	100		5TL13910	1580.-	1/1
	125		5TL13920	1710.-	1/1
	32	4	5TL14320	1095.-	1/1
	40		5TL14400	1305.-	1/1
	63		5TL14630	1480.-	1/1
	80		5TL14800	1780.-	1/1
	100		5TL14910	2140.-	1/1
	125		5TL14920	2325.-	1/1

Note:

* MRP - Maximum Retail Price # 1MW (Module Width) = 18mm

** Purchase MOQ for our authorised dealers is in multiples of standard packing, contact Siemens Sales Office for further details

SIEMENS

Ingenuity for life



Celebrate Life, while we Care.



Betagard 5SV

Residual Current Circuit Breakers



In the event of a fault, residual current protective devices reliably disconnect power to protect humans

Fault protection

"Protection against indirect contact"

Protects people in the event of contact with electrically conductive parts, if a risk exists as a result of a fault due to the magnitude or duration of the touch voltage



Additional protection

"Protection in case of direct contact" with $I_{\Delta n} = 30\text{mA}$

Protects individuals if they come in direct contact with an active live part under normal operating condition



Fire protection

"Protection from insulation faults" with $I_{\Delta n} = 300\text{mA}$

For the prevention of fires which can be caused by insulation faults in locations exposed to fire hazards



Surge current withstand capability

"Protection surge currents" with $8/20\mu\text{s} > 1000\text{Amp}$

For Type "A"  have a surge current capability to avoid nuisance tripping





Betagard Residual Current Circuit Breakers 5SV





- Standards: IS 12640, Part 1:2008/IEC 61008-1:1996
- Voltage: 240/415VAC, 50Hz
- With ISI marking: CM/L No. 7676092

Type AC, applicable in networks for AC residual currents

	Rated residual current $I_{\Delta n}$ (mA)	Rated Current I_n (A)	MW#	Reference No	Unit MRP* ₹	Std. Pkg.** (Nos.)	
	2 Pole	30	25	2			
		100	25		■ 5SV43120RC	3195.-	1
		300	25		5SV44120RC	3335.-	1
		30	40		5SV46120RC	3350.-	1
		100	40		■ 5SV43140RC	3745.-	1
		300	40		5SV44140RC	3905.-	1
		30	63		5SV46140RC	3940.-	1
		100	63		■ 5SV43160RC	5005.-	1
		300	63		5SV44160RC	5045.-	1
		30	80		5SV46160RC	5215.-	1
		100	80		5SV43170RC	7530.-	1
		300	80		5SV44170RC	7825.-	1
					5SV46170RC	7825.-	1
		4 Pole	30	25	4		
		100	25		■ 5SV43420RC	4275.-	1
		300	25		5SV44420RC	4435.-	1
		30	40		5SV46420RC	4470.-	1
		100	40		■ 5SV43440RC	4330.-	1
		300	40		5SV44440RC	4495.-	1
		30	63		5SV46440RC	4535.-	1
		100	63		■ 5SV43460RC	5045.-	1
		300	63		5SV44460RC	5245.-	1
		30	80		5SV46460RC	5280.-	1
		100	80		5SV43470RC	7530.-	1
		300	80		5SV44470RC	7825.-	1
					5SV46470RC	7825.-	1

Type A, applicable in networks with AC and/or pulsating DC residual currents

	2 Pole	30	25	2			
		100	25		5SV33126RC	5680.-	1
		300	25		5SV34126RC	6690.-	1
		30	40		5SV36126RC	6690.-	1
		100	40		5SV33146RC	6440.-	1
		300	40		5SV34146RC	6710.-	1
		30	63		5SV36146RC	6710.-	1
		100	63		5SV33166RC	9365.-	1
		300	63		5SV34166RC	9630.-	1
		30	80		5SV36166RC	9170.-	1
		100	80		5SV33176RC	10075.-	1
		300	80		5SV34176RC	10835.-	1
					5SV36176RC	10315.-	1
		4 Pole	30	25	4		
		100	25		5SV33426RC	6735.-	1
		300	25		5SV34426RC	8310.-	1
		30	40		5SV36426RC	8310.-	1
		100	40		5SV33446RC	7435.-	1
		300	40		5SV34446RC	8310.-	1
		30	63		5SV36446RC	8310.-	1
		100	63		5SV33466RC	8490.-	1
		300	63		5SV34466RC	8440.-	1
		30	80		5SV36466RC	8440.-	1
		100	80		5SV33476RC	10210.-	1
		300	80		5SV34476RC	10835.-	1
					5SV36476RC	10315.-	1

■ Stock items

Note:

* MRP - Maximum Retail Price # 1MW (Module Width) = 18mm

** Purchase MOQ for our authorised dealers is in multiples of standard packing, contact Siemens Sales Office for further details

Betagard Residual Current Circuit Breakers 5SM3



- Standards: IS 12640, Part 1:2008/IEC 61008-1:1996
- Voltage: 240/415VAC, 50Hz
- With ISI marking: CM/L No. 7676092

Type AC, applicable in networks for AC residual currents

	Rated residual current $I_{\Delta n}$ (mA)	Rated Current I_n (A)	MW#	Reference No	Unit MRP* ₹	Std. Pkg.** (Nos.)
	30	100	4	5SM33480RC	40390.-	1
	100	100		5SM34480RC	35835.-	1
	300	100		5SM36480RC	33970.-	1
	30	125		5SM33450RC	40390.-	1
	100	125		5SM34450RC	35835.-	1
	300	125		5SM36450RC	33970.-	1
	500	125		5SM37450RC	39120.-	1

Type A, applicable in networks with AC and/or pulsating DC residual currents

	30	100	4	5SM33486RC	37020.-	1
	100	100		5SM34486RC	35685.-	1
	300	100		5SM36486RC	36255.-	1
	30	125		5SM33456RC	37020.-	1
	100	125		5SM34456RC	35685.-	1
	300	125		5SM36456RC	39550.-	1
	500	125		5SM37456RC	40755.-	1

Note:

* MRP - Maximum Retail Price # 1MW (Module Width) = 18mm

** Purchase MOQ for our authorised dealers is in multiples of standard packing, contact Siemens Sales Office for further details

The right type for your application..

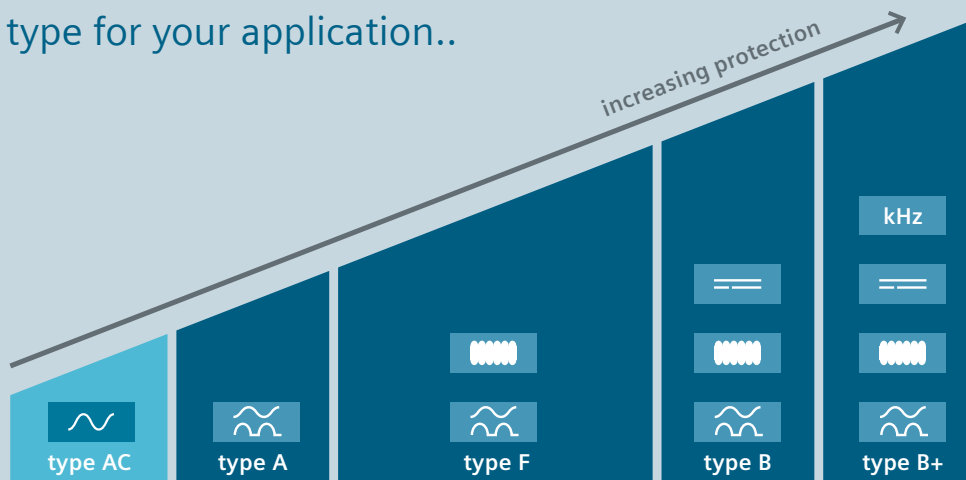

- sinusoidal alternating currents (type AC)
- pulsating DC residual currents (type A)

- electrical loads with frequency converters in the single-phase alternating currents (type F)

- smooth DC residual currents (type B/B+)

More information:
siemens.com/rccb

Betagard Residual Current Breaker Operators 5SU1, 10kA





- Standards: IS 12640, Part 2:2008/IEC 61009-1:1996
- Voltage: 240/415Vac, 50Hz
- With ISI marking: CM/L No. 7676193



Type AC, with C Characteristics (in 2 module size)

	Rated residual current $I_{\Delta n}$ (mA)	Rated Current I_n (A)	MW#	Reference No	Unit MRP* ₹	Std. Pkg.** (Nos.)
	240Vac; 50Hz; 2 pole ¹⁾					
	30	6	2	5SU13541RC06	5230.-	1
	30	10		5SU13541RC10	5230.-	1
	30	16		5SU13541RC16	5230.-	1
	30	20		5SU13541RC20	5230.-	1
	30	25		5SU13541RC25	5230.-	1
	30	32		5SU13541RC32	5490.-	1
	30	40		5SU13541RC40	6495.-	1
	300	6		5SU16541RC06	5330.-	1
	300	10		5SU16541RC10	5330.-	1
	300	16		5SU16541RC16	5330.-	1
	300	20		5SU16541RC20	5330.-	1
	300	25		5SU16541RC25	5330.-	1
	300	32		5SU16541RC32	5600.-	1
	300	40		5SU16541RC40	6620.-	1

Type AC with C characteristic

	240Vac; 50Hz; 2 pole					
	30	32	4	5SU13241RC32	4980.-	1
		40		5SU13241RC40	5805.-	1
		63		5SU13241RC63	6750.-	1
	100	32		5SU14241RC32	5500.-	1
		40		5SU14241RC40	6180.-	1
		63		5SU14241RC63	7200.-	1
	300	32		5SU16241RC32	5560.-	1
		40		5SU16241RC40	6235.-	1
	63		5SU16241RC63	7200.-	1	
	415Vac; 50Hz; 4 pole					
	30	32	7	5SU13441RC32	6655.-	1
		40		5SU13441RC40	6775.-	1
		63		5SU13441RC63	8040.-	1
	100	32		5SU14441RC32	6735.-	1
		40		5SU14441RC40	6865.-	1
		63		5SU14441RC63	7895.-	1
	300	32		5SU16441RC32	6790.-	1
		40		5SU16441RC40	6925.-	1
	63		5SU16441RC63	7970.-	1	

Type AC with D characteristic

	240Vac; 50Hz; 2 pole					
	30	32	4	5SU13242RC32	6425.-	1
		40		5SU13242RC40	7040.-	1
		63		5SU13242RC63	8485.-	1
	100	32		5SU14242RC32	7775.-	1
		40		5SU14242RC40	8510.-	1
		63		5SU14242RC63	9720.-	1
	300	32		5SU16242RC32	7600.-	1
		40		5SU16242RC40	8510.-	1
	63		5SU16242RC63	9730.-	1	
	415Vac; 50Hz; 4 pole					
	30	32	7	5SU13442RC32	8800.-	1
		40		5SU13442RC40	8935.-	1
		63		5SU13442RC63	10595.-	1
	100	32		5SU14442RC32	9525.-	1
		40		5SU14442RC40	9950.-	1
		63		5SU14442RC63	11030.-	1
	300	32		5SU16442RC32	9405.-	1
		40		5SU16442RC40	10050.-	1
	63		5SU16442RC63	10805.-	1	

Note: * MRP - Maximum Retail Price # 1MW (Module Width) = 18mm ¹⁾ 1P+N variant

** Purchase MOQ for our authorised dealers is in multiples of standard packing, contact Siemens Sales Office for further details

Betagard Residual Current Breaker Operators

5SU1, 10kA





- Standards: IS 12640, Part 2:2008/IEC 61009-1:1996
- Voltage: 240/415Vac, 50Hz
- With ISI marking: CM/L No. 7676193



Type A, with C Characteristics (in 2 module size)

	Rated residual current $I_{\Delta n}$ (mA)	Rated Current I_n (A)	MW [#]	Reference No	Unit MRP* ₹	Std. Pkg.** (Nos.)
	240Vac; 50Hz; 2 pole ¹⁾					
	30	6	2	5SU13547RC06	9555.-	1
	30	10		5SU13547RC10	9555.-	1
	30	16		5SU13547RC16	9555.-	1
	30	20		5SU13547RC20	9555.-	1
	30	25		5SU13547RC25	9555.-	1
	30	32		5SU13547RC32	9990.-	1
	30	40		5SU13547RC40	12090.-	1
	300	6		5SU16547RC06	9840.-	1
	300	10		5SU16547RC10	9840.-	1
	300	16		5SU16547RC16	9840.-	1
	300	20		5SU16547RC20	9840.-	1
	300	25		5SU16547RC25	9840.-	1
	300	32		5SU16547RC32	10230.-	1
	300	40		5SU16547RC40	12340.-	1

Type A with C characteristic

	240Vac; 50Hz; 2 pole						
	30	32	4	5SU13247RC32	9025.-	1	
		40		5SU13247RC40	9935.-	1	
		63		5SU13247RC63	11235.-	1	
	100	32		5SU14247RC32	9635.-	1	
		40		5SU14247RC40	10700.-	1	
		63		5SU14247RC63	12160.-	1	
	300	32		5SU16247RC32	9635.-	1	
		40		5SU16247RC40	10700.-	1	
		63		5SU16247RC63	12160.-	1	
		415Vac; 50Hz; 4 pole					
		30	32	7	5SU13447RC32	11055.-	1
40			5SU13447RC40		11510.-	1	
63			5SU13447RC63		13165.-	1	
100		32		5SU14447RC32	11855.-	1	
		40		5SU14447RC40	12085.-	1	
		63		5SU14447RC63	13510.-	1	
300		32		5SU16447RC32	11855.-	1	
		40		5SU16447RC40	12295.-	1	
		63		5SU16447RC63	13720.-	1	

Type A with D characteristic

	240Vac; 50Hz; 2 pole						
	30	32	4	5SU13248RC32	10535.-	1	
		40		5SU13248RC40	11890.-	1	
		63		5SU13248RC63	13525.-	1	
	100	32		5SU14248RC32	11335.-	1	
		40		5SU14248RC40	12605.-	1	
		63		5SU14248RC63	14360.-	1	
	300	32		5SU16248RC32	11335.-	1	
		40		5SU16248RC40	12605.-	1	
		63		5SU16248RC63	14360.-	1	
		415Vac; 50Hz; 4 pole					
		30	32	7	5SU13448RC32	13040.-	1
40			5SU13448RC40		13205.-	1	
63			5SU13448RC63		15570.-	1	
100		32		5SU14448RC32	13735.-	1	
		40		5SU14448RC40	14680.-	1	
		63		5SU14448RC63	15980.-	1	
300		32		5SU16448RC32	13735.-	1	
		40		5SU16448RC40	14680.-	1	
		63		5SU16448RC63	15985.-	1	

Note: * MRP - Maximum Retail Price



1MW (Module Width) = 18mm

¹⁾ 1P+N variant

** Purchase MOQ for our authorised dealers is in multiples of standard packing, contact Siemens Sales Office for further details

Betagard Accessories

Accessories for 5SL / 5SY / 5SP MCBs, 5TL isolators, 5SV/5SM RCCBs and 5SU1 RCBOs

Item Description	Reference No	Unit MRP* ₹	Std. Pkg.** (Nos.)
 <p>Aux contact block (For 5SL/5SY/5SP4/5TL/5SV/5SU1)</p> <p>1NO+1NC 2NO 2NC 1CO</p>	5ST3010	1095.-	12
	5ST3011	1115.-	1
	5ST3012	1115.-	1
	5ST3016	1740.-	1
<p>Fault signal contact (For 5SL/5SY/5SP4/5SV/5SU1)</p> <p>1NO+1NC 2NO 2NC</p>	5ST3020	1610.-	1
	5ST3021	1635.-	1
	5ST3022	1635.-	1
<p>Shunt release (For 5SL5/5SL7/5SY/5SP4/5SV/5SU1)</p> <p>110...415V AC 24...48V DC</p>	5ST3030	4520.-	1/5
	5ST3031	4520.-	1/5
<p>Auxiliary and fault signal changeover contact (For 5SL/5SY/5SP4/5TL/5SV/5SU1)</p> <p>Auxiliary switch - 1CO Fault contact - 1CO</p>	5ST3062	4930.-	1
<p>Auxiliary contact block for 5SM3 100-125A 4pole</p> <p>1NO+1NC</p>	5SW3330	4610.-	1/10
 <p>Undervoltage release (For 5SL5/5SL7/5SY/5SP4/5SV/5SU1)</p> <p>With integrated aux. switch 230V AC 110V DC 24V DC</p> <p>Without integrated aux. switch 230V AC 110V DC 24V DC</p>	5ST3040	6060.-	1/5
	5ST3041	6060.-	1/5
	5ST3042	6060.-	1/5
	5ST3043	6060.-	1/5
	5ST3044	6060.-	1/5
	5ST3045	6060.-	1/5
 <p>Remote control mechanism unit Basic version for 5SL,5SY,5TL1 and 5SU1 (1P+N only) (12-30)VAC & (12-48)VDC, 1.5MW 230VAC, 2MW</p> <p>Power version for 5SL,5SY,5TL1 and 5SU1 (12-30)VAC & (12-48)VDC, 2MW 230VAC, 2MW</p> <p>Adapter for Remote control mechanism (To be ordered along with 5ST305X basic unit) For 5SL - 1P & 2P, 5SV - 4P For 5SL - 3P & 4P For 5SY - 1P & 2P and For 5SU1[^] - 2P, 4M For 5SY - 3P & 4P and For 5SU1[^] - 4P, 7M For 5SU1 - 2P, 2M [^] Add-on block for 5SU1 to be ordered along with Adapter</p>	5ST3053	27030.-	1
	5ST3054	27030.-	1
	5ST3055	45745.-	1
	5ST3056	45745.-	1
	5ST38206	570.-	1
	5ST38207	570.-	1
	5ST38201	570.-	1
	5ST38202	570.-	1
	5ST38205	570.-	1
	5ST38203	1245.-	1
 <p>Handle locking device</p> <p>for 5SP and 5SY circuit breakers for padlock with max. 3mm shackle</p>	5ST3801	560.-	1
	5ST3806	530.-	5
 <p>Pad locks for 5ST3801 and 5ST3806 handle locking devices</p>	5ST3802	360.-	5
 <p>Handle connector for 2P, 2M 5SU1 RCBO⁵</p>	5ST38051	1120.-	1

Betagard Rotary Handle Assembly

Item Description	Reference No.	Unit MRP* ₹	Std. Pkg.** (Nos.)
 <p>Rotary Handle Assembly for 5SY, 5SL, 5SP and 5TL1 series of MCBs/ Isolators⁵⁵</p>	5ST38140RC	2010.-	1

Note: * MRP - Maximum Retail Price # 1MW (Module Width) = 18mm

\$ For 2P, 2M RCBOs, the accessories can be used along with Handle connector only

\$\$ Not suitable for 1P MCBs

** Purchase MOQ for our authorised dealers is in multiples of standard packing, contact Siemens Sales Office for further details

SIEMENS

Ingenuity for life



SIRENEW

Power Distribution Solution
for RENEWables

thanks to

SIARC

technology

World's smallest AFDD

Thanks to innovative SIARC technology, the AFDD is the only protection device that detects parallel as well as serial arcing faults. Common causes are, among others:

First arc fault detection device (AFDD) in the IEC market (2012) for preventive fire protection
First AFDD with integrated MCB in 1 modular width (MW)

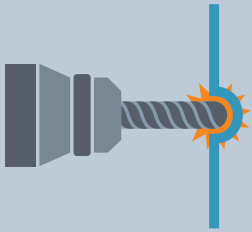

damaged wire insulation



crushed cables

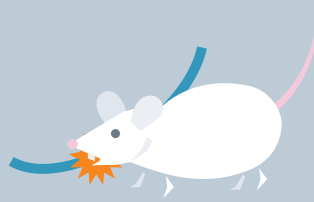

rodent damage

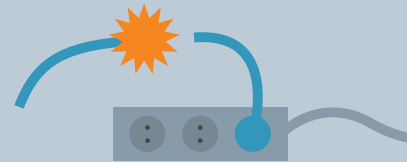

broken cables

#1 Be the first to play it safe with the 5SV6 AFDD

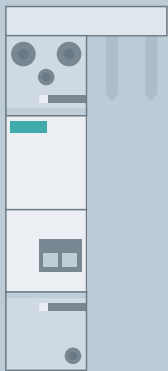

Arc fault detection unit

+



Miniature circuit breaker

=

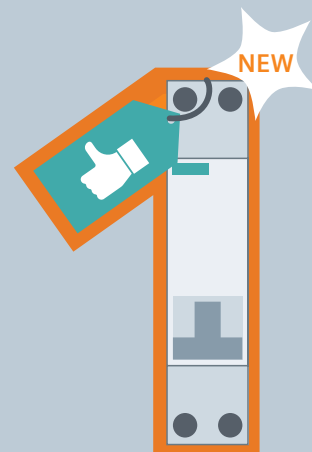

5SV6 AFDD

1 MW

AFDDs are strongly recommended!

Comprehensive portfolio for preventive fire protection

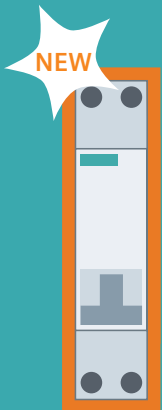

5SV6 AFDD
+ integrated MCB = 1 MW

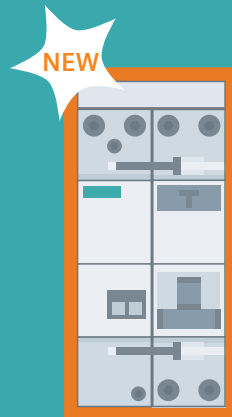

5SM6 AFD unit
+ 5SV1 RCBO = 2 MW



5SM6 AFD unit
+ 5SY60 MCB = 2 MW

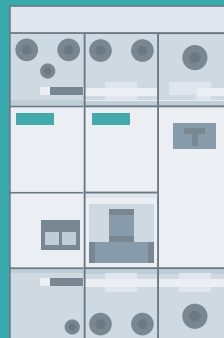

5SM6 AFD unit
+ 5SU1 RCBO = 3 MW

More information available at [siemens.com/afdd](https://www.siemens.com/afdd)

It's Time to Act Now!

Preventive, Proven, Standard compliant

[siemens.com/protection-concept](https://www.siemens.com/protection-concept)



SIEMENS

Ingenuity for life

Arc Fault Detection Device

It's Time to Act Now!

With the 5SV6 Arc Fault Detection Device (AFDD), Siemens presents the third generation of fire-prevention product. The 5SV6 Arc Fault Detection Device with integrated miniature circuit breaker (MCB) is the first device on the IEC market with just one module width and is the smallest of its kind worldwide.

A standard-compliant expansion of the electrical installation by protection against electrical fires is thus always possible – easily and without the need for additional space.

www.siemens.com/afd-units

NEW



The smart solution.

Whether in an existing plant or a new installation – the 5SV6 AFDD and 5SM6 AFD unit can be deployed in any distribution board. It quickly identifies dangerous faults caused by parallel or serial arcing faults and switches off before a fire occurs. The AFDD detects operational arcing faults and only trips in the event of an actual fault.

5SV6 AFDDs with Integrated MCB & RCBO in 18mm width

	Rating	With integrated MCB		With integrated RCBO	Unit LP* ₹
		B characteristic	C characteristic	30mA, Type AC, C characteristic	
	6A	5SV60166KK06	5SV60167KK06	5SV63167KK06	Price on Request
	10A	5SV60166KK10	5SV60167KK10	5SV63167KK10	
	13A	5SV60166KK13	5SV60167KK13	5SV63167KK13	
	16A	5SV60166KK16	5SV60167KK16	5SV63167KK16	
	20A	5SV60166KK20	5SV60167KK20	5SV63167KK20	
	25A	5SV60166KK25	5SV60167KK25	5SV63167KK25	
	32A	5SV60166KK32	5SV60167KK32	5SV63167KK32	
	40A	5SV60166KK40	5SV60167KK40	5SV63167KK40	

5SM6 AFDD with integrated MCB

	Rating	Module width	Reference No.	Description	Unit LP* ₹
	16A	2	5SM60111XX02	AFDD 16A, 230V, 2MW (Integrated with 1MW, 1+N, 16A MCB)	Price on Request

5SM6 AFD units (Suitable for add on with RCBO)

	Rating	Module width	Reference No.	Description	Unit LP* ₹
	16A	3	5SM60212	AFD Unit 1-16A, 230V, 1MW (Suitable for 2P 2M, 5SU1 RCBO)	Price on Request
	40A	3	5SM60242	AFD Unit 1-40A, 230V, 1MW (Suitable for 2P 2M, 5SU1 RCBO)	

* LP - List Price

SIEMENS

Ingenuity for life









Perfect blend of beauty and features with assured performance

Betagard Distribution Boards

- Complete range for Residential, Commercial and Industrial Infrastructures
- DBs offer latest design with highest aesthetic appeal
- DBs available with type testing as per the latest applicable standards
- User friendly design offers ease during maintenance and assists the installer for correct installation

Betagard Distribution Boards 8GB32 # SPN and TPN DBs

- Type Tested as per IEC 61439 Standards at third party and internal test laboratories
- Available in IP 20 and IP 43 Versions
- Single Door, Metal Double Door and Acrylic Double Door options available
- Standard Wire Way Boxes available for all Single Door and Double Door DBs
- Additional safety with Insulated Shorting Links, Shrouded Neutral Links and Door Earthing
- TPN DBs can be easily made suitable for PPI configuration using TPN to PPI Conversion Kits
- Detachable DIN rail assembly and intermittent door facilitates ease in Wiring during installation and maintenance
- DBs are subjected to Seven tank process and treated with premium quality powder coating
- Cement Masking Sheet protects the DBs against extreme site conditions

	Item Description	Incoming Slots (MW)	Outgoing Slots (MW)	Total Slots (MW)	Reference No	Unit MRP* ₹	Std. Pkg.** (Nos.)
Metal Enclosures, IP20:							
	1 Module	–	–	1	8GB32100RC01	500.-	1/20
	2 Module	–	–	2	8GB32100RC02	740.-	1/20
	3 Module	–	–	3	8GB32100RC03	740.-	1/20
	4 Module	–	–	4	8GB32100RC04	740.-	1/20
	6 Module	–	–	6	8GB32100RC06	980.-	1/20
	8 Module	–	–	8	8GB32100RC08	1150.-	1/10
SPN Single Door DBs, IP20:							
	6 Module	2	4	6	8GB32101RC06	1465.-	1
	8 Module	2	6	8	8GB32101RC08	1555.-	1
	10 Module	2	8	10	8GB32101RC10	1875.-	1
	12 Module	2	10	12	8GB32101RC12	1945.-	1
	14 Module	2	12	14	8GB32101RC14	2195.-	1
	16 Module	2	14	16	8GB32101RC16	2365.-	1
SPN Metal Double Door DBs, IP 43:							
	6 Module	2	4	6	8GB32102RC06	2290.-	1
	8 Module	2	6	8	8GB32102RC08	2380.-	1
	10 Module	2	8	10	8GB32102RC10	2770.-	1
	12 Module	2	10	12	8GB32102RC12	2845.-	1
	14 Module	2	12	14	8GB32102RC14	3315.-	1
	16 Module	2	14	16	8GB32102RC16	3395.-	1
SPN Acrylic Double Door DBs, IP 43:							
	6 Module	2	4	6	8GB32103RC06	2690.-	1
	8 Module	2	6	8	8GB32103RC08	2845.-	1
	10 Module	2	8	10	8GB32103RC10	3315.-	1
	12 Module	2	10	12	8GB32103RC12	3555.-	1
	14 Module	2	12	14	8GB32103RC14	3715.-	1
	16 Module	2	14	16	8GB32103RC16	3870.-	1
Wire Way Box For SPN Single Door IP 20 DBs:							
	For 6 MOD SPN Single door DB	–	–	–	8GB32106RC06	965.-	1/5
	For 8 MOD SPN Single door DB	–	–	–	8GB32106RC08	965.-	1/5
	For 10 MOD SPN Single door DB	–	–	–	8GB32106RC10	1040.-	1/5
	For 12 MOD SPN Single door DB	–	–	–	8GB32106RC12	1040.-	1/5
	For 14 MOD SPN Single door DB	–	–	–	8GB32106RC14	1200.-	1/5
	For 16 MOD SPN Single door DB	–	–	–	8GB32106RC16	1200.-	1/5
Wire Way Box For SPN Double Door IP 43 DBs:							
	For 6 MOD SPN Double door DB	–	–	–	8GB32107RC06	1040.-	1/5
	For 8 MOD SPN Double door DB	–	–	–	8GB32107RC08	1040.-	1/5
	For 10 MOD SPN Double door DB	–	–	–	8GB32107RC10	1125.-	1/5
	For 12 MOD SPN Double door DB	–	–	–	8GB32107RC12	1125.-	1/5
	For 14 MOD SPN Double door DB	–	–	–	8GB32107RC14	1435.-	1/5
	For 16 MOD SPN Double door DB	–	–	–	8GB32107RC16	1435.-	1/5

Note: * MRP - Maximum Retail Price # Also available in flat door option

For Customized Solutions in Distribution Boards please Contact our sales Office

** Purchase MOQ for our authorised dealers is in multiples of standard packing, contact Siemens Sales Office for further details

Betagard Distribution Boards 8GB32 # SPN and TPN DBs

	Item Description	Incoming Slots (MW)	Outgoing Slots (MW)	Total Slots (MW)	Reference No	Unit MRP* ₹	Std. Pkg.** (Nos.)
TPN Single Door DBs, IP20:							
	4 way	8	12	20	8GB32201RC04	3685.-	1
	6 way	8	18	26	8GB32201RC06	4185.-	1
	8 way	8	24	32	8GB32201RC08	5055.-	1
	10 way	8	30	38	8GB32201RC10	7330.-	1
	12 way	8	36	44	8GB32201RC12	7485.-	1
	14 way	8	42	50	8GB32201RC14	8585.-	1
	16 way	8	48	56	8GB32201RC16	8910.-	1
TPN Metal Double Door DBs, IP 43							
	4 way	8	12	20	8GB32202RC04	4505.-	1
	6 way	8	18	26	8GB32202RC06	5445.-	1
	8 way	8	24	32	8GB32202RC08	6545.-	1
	10 way	8	30	38	8GB32202RC10	9455.-	1
	12 way	8	36	44	8GB32202RC12	9690.-	1
	14 way	8	42	50	8GB32202RC14	11500.-	1
	16 way	8	48	56	8GB32202RC16	11825.-	1
TPN Acrylic Double Door DBs, IP 43							
	4 way	8	12	20	8GB32203RC04	5445.-	1
	6 way	8	18	26	8GB32203RC06	6705.-	1
	8 way	8	24	32	8GB32203RC08	8040.-	1
	10 way	8	30	38	8GB32203RC10	10485.-	1
	12 way	8	36	44	8GB32203RC12	12205.-	1
	14 way	8	42	50	8GB32203RC14	13075.-	1
	16 way	8	48	56	8GB32203RC16	13950.-	1
TPN to PPI Conversion Kit®							
	To convert 6 way TPN DB to 4 way TPN PPI DB				8GB32205RC04	2845.-	1/5
	To convert 8 way TPN DB to 6 way TPN PPI DB				8GB32205RC06	3315.-	1/5
	To convert 10 way TPN DB to 8 way TPN PPI DB				8GB32205RC08	3395.-	1/5
	To convert 12 way TPN DB to 10 way TPN PPI DB				8GB32205RC10	3630.-	1/5
	To convert 14 way TPN DB to 12 way TPN PPI DB				8GB32205RC12	3870.-	1/5
	To convert 16 way TPN DB to 14 way TPN PPI DB				8GB32205RC14	4100.-	1/5
Wire Way Box For TPN Single Door IP 20 DBs							
	For 4 Way TPN Single door DB	-	-	-	8GB32206RC04	1200.-	1/5
	For 6 Way TPN Single door DB	-	-	-	8GB32206RC06	1200.-	1/5
	For 8 Way TPN Single door DB	-	-	-	8GB32206RC08	2140.-	1/5
	For 10 Way TPN Single door DB	-	-	-	8GB32206RC10	2690.-	1/5
	For 12 Way TPN Single door DB	-	-	-	8GB32206RC12	2770.-	1/5
	For 14 Way TPN Single door DB	-	-	-	8GB32206RC14	2845.-	1/5
	For 16 Way TPN Single door DB	-	-	-	8GB32206RC16	3010.-	1/5
Wire Way Box For TPN Double Door IP 43 DBs							
	For 4 Way TPN Double door DB	-	-	-	8GB32207RC04	1275.-	1/5
	For 6 Way TPN Double door DB	-	-	-	8GB32207RC06	1435.-	1/5
	For 8 Way TPN Double door DB	-	-	-	8GB32207RC08	2290.-	1/5
	For 10 Way TPN Double door DB	-	-	-	8GB32207RC10	2450.-	1/5
	For 12 Way TPN Double door DB	-	-	-	8GB32207RC12	3010.-	1/5
	For 14 Way TPN Double door DB	-	-	-	8GB32207RC14	3160.-	1/5
	For 16 Way TPN Double door DB	-	-	-	8GB32207RC16	3250.-	1/5

Note: * MRP - Maximum Retail Price

@ Contains required accessories to Make the DB suitable for PPI Configuration
For Customized Solutions in Distribution Boards please Contact our sales Office

** Purchase MOQ for our authorised dealers is in multiples of standard packing, contact Siemens Sales Office for further details

Also available in flat door option

Betagard Distribution Boards 8GB32 TPN Phase Segregated DBs

Item Description	Incoming Slots (MW)	Sub - Incomer Slots (MW)	Outgoing Slots (MW)	Total Slots (MW)	Reference No	Unit MRP* ₹	Std. Pkg.** (Nos.)
TPN Phase segregated DBs, IP 20 For MCB as incomer							
4 Way	12	12	12	36	8GB32001RC04	10155.-	1
6 Way	12	12	18	42	8GB32001RC06	11420.-	1
8 Way	12	12	24	48	8GB32001RC08	13330.-	1
12 Way	12	12	36	60	8GB32001RC12	15870.-	1
TPN Phase segregated DBs, (8 segment) IP 43 For MCB as incomer							
4 way	12	12	12	36	8GB32002RC04	12060.-	1
6 way	12	12	18	42	8GB32002RC06	13965.-	1
8 way	12	12	24	48	8GB32002RC08	15870.-	1
12 way	12	12	36	60	8GB32002RC12	19045.-	1
TPN Phase segregated DBs, IP 43 for MCCB as incomer upto 160A							
6 way		12	18	30	8GB32012RC06	21575.-	1
8 way		12	24	36	8GB32012RC08	24750.-	1
12 way		12	36	48	8GB32012RC12	27925.-	1
Wire Way box for MCB Incomer, IP 43 DBs							
For 4 Way	-	-	-	-	8GB32007RC04	3170.-	1
For 6 Way	-	-	-	-	8GB32007RC06	3805.-	1
For 8 Way	-	-	-	-	8GB32007RC08	4440.-	1
For 12 Way	-	-	-	-	8GB32007RC12	5070.-	1
Wire Way box for MCCB Incomer, IP 43 DBs							
For 6 Way	-	-	-	-	8GB32017RC06	3805.-	1
For 8 Way	-	-	-	-	8GB32017RC08	4440.-	1
For 12 Way	-	-	-	-	8GB32017RC12	5070.-	1

Betagard Distribution Board 8GB

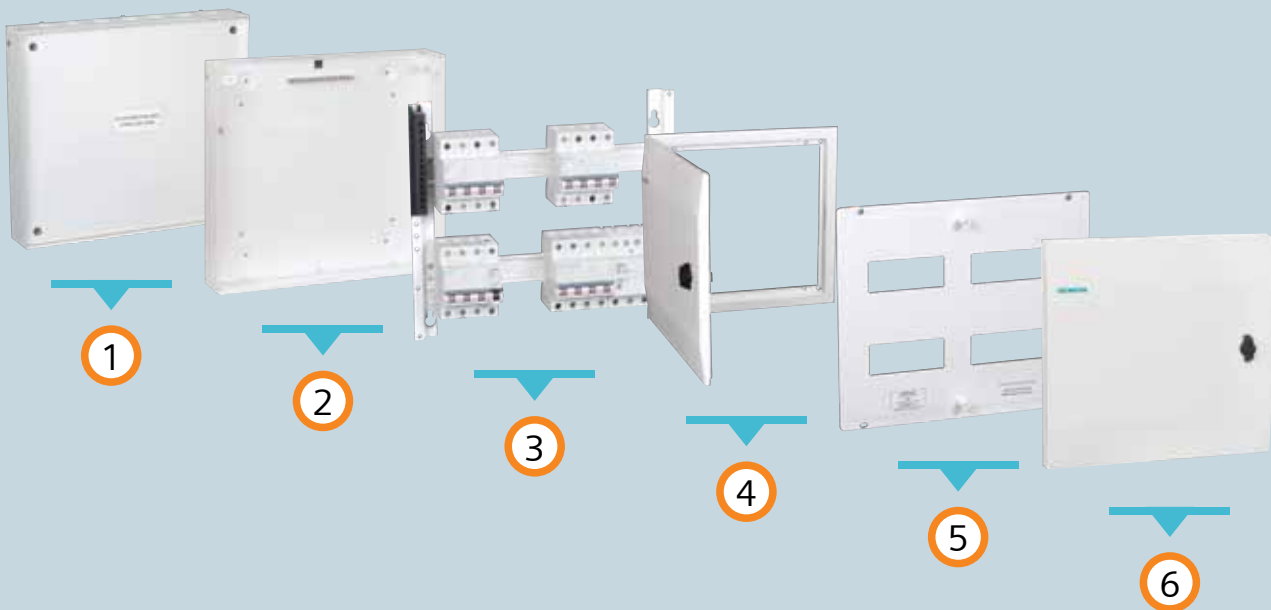

1 U-box with Cement Masking sheet

2 U-box with Earth links

3 Detachable Din-rail channel with Shrouded Neutral link

4 Door frame with Door

5 Detachable Intermittent Plate

6 Door with Quarter Turn Knob

Betagard Distribution Boards 8GB0 SPN and TPN DBs

	Item Description	Incoming Slots (MW)	Outgoing Slots (MW)	Total Slots (MW)	Reference No	Unit MRP* ₹	Std. Pkg.** (Nos.)
Plastic Enclosure, IP20:							
	3/4 Way	-	-	4	8GB0004	250.-	1/50
	6 Way	-	-	6	8GB0006	380.-	1/25
Double Door SPN DBs, IP42 :							
	4 Way	2	4	6	8GB0204RC	2070.-	1
	6 Way	2	6	8	8GB0206RC	2135.-	1
	8 Way	2	8	10	8GB0208RC	2500.-	1
	12 Way	2	12	14	8GB0212RC	2985.-	1
	14 Way	2	14	16	8GB0214RC	3065.-	1
Double Door TPN DBs (Horizontal), IP42 :							
	4 Way	8	12	20	8GB0404HRC	4055.-	1
	6 Way	8	18	26	8GB0406HRC	4975.-	1
	8 Way	8	24	32	8GB0408HRC	6040.-	1
	12 Way	8	36	44	8GB0412HRC	8725.-	1
Double Door TPN DBs (Vertical), IP42 :							
	4 Way	8	12	20	8GB0404VRC	Price on request	1
	6 Way	8	18	26	8GB0406VRC		1
	8 Way	8	24	32	8GB0408VRC		1
	12 Way	8	36	44	8GB0412VRC		1
Double Door, Per Phase Isolation TPN DBs (Horizontal), IP42 :							
	4 Way	8	18	26	8GB0405HRC	7095.-	1
	6 Way	8	24	32	8GB0407HRC	8160.-	1
	8 Way	8	30	38	8GB0409HRC	10885.-	1
	12 Way	8	42	50	8GB0413HRC	13105.-	1
Double Door, Per Phase Isolation TPN DBs (Vertical), IP42 :							
	4 Way	8	18	26	8GB0405VRC	Price on request	1
	6 Way	8	24	32	8GB0407VRC		1
	8 Way	8	30	38	8GB0409VRC		1
	12 Way	8	42	50	8GB0413VRC		1
Double Door, Phase Segregated TPN DBs (7 segment), IP42:							
	4 Way	12	12+12	36	8GB0504	9820.-	1
	6 Way	12	12+18	42	8GB0506	11110.-	1
	8 Way	12	12+24	48	8GB0508	12390.-	1
	12 Way	12	12+36	60	8GB0512	15690.-	1

Betagard Distribution Boards 8GB31

	Item Description	Incoming Slots (MW)	Outgoing Slots (MW)	Total Slots (MW)	Reference No	Unit MRP* ₹	Std. Pkg.** (Nos.)
Betaflex (Flexi DBs), IP42 :							
	2Row x 12Mod	—	—	24	8GB31424RC	5700.-	1
	2Row x 16Mod	—	—	32	8GB31426RC	6045.-	1
	4Row x 6Mod	—	—	24	8GB31441RC	6730.-	1
	4Row x 8Mod	—	—	32	8GB31442RC	7005.-	1
	4Row x 10Mod	—	—	40	8GB31443RC	7525.-	1
	4Row x 12Mod	—	—	48	8GB31444RC	7800.-	1
	4Row x 16Mod	—	—	64	8GB31446RC	11960.-	1
Betabus (Vertical Busbar DBs with MCB as an incomer), IP42 : (Suitable for 5SL/5SP MCBs, upto 125A as an incomer)							
	4 way	12	12	24	8GB31471RC	10055.-	1
	6 way	12	18	30	8GB31473RC	12240.-	1
	8 way	12	24	36	8GB31474RC	12910.-	1
	12 way	12	36	48	8GB31477RC	17560.-	1
Betabusplus (Vertical Busbar DBs with MCCB as an incomer), IP42 : (Suitable for 3VT1/3VA1 MCCBs, upto 160A as an incomer)							
	4 way	12	12	24	8GB31571RC	11250.-	1
	6 way	12	18	30	8GB31572RC	14195.-	1
	8 way	12	24	36	8GB31573RC	15315.-	1
	12 way	12	36	48	8GB31574RC	20400.-	1
BetaMulti (DBs for power & communication), IP42 :							
	12 way SPN, provision	2	12	14	8GB31215RC	5560.-	1
	4 Way TPN, Provision	8	12	20	8GB31220RC	6905.-	1
	6 way TPN, provision	8	18	26	8GB31221RC	7210.-	1
	8 Way TPN Provision	8	24	32	8GB31222RC	7960.-	1
	12 way SPN, built-in	2	12	14	8GB31315RC	Price on request	1
	4 Way TPN, Built-in	8	12	20	8GB31320RC	Price on request	1
	6 way TPN, built-in	8	18	26	8GB31321RC	Price on request	1
	8 Way TPN, Built-in	8	24	32	8GB31322RC	Price on request	1
Beta CO (DBs with provision for phase changeover switches), IP42 :							
	4 way, with provision	8	12	20	8GB31840RC	Price on request	1
	6 way, with provision	8	18	26	8GB31841RC		1
	8 way, with provision	8	24	32	8GB31842RC		1
	12 way, with provision	8	36	44	8GB31844RC		1
Beta CO (DBs with built-in pre-wired phase changeover switches), IP42 :							
	40 A, 4 Way TPN, built-in	8	12	20	8GB31850RC	13815.-	1
	40 A, 6 Way TPN, built-in	8	18	26	8GB31851RC	14250.-	1
	40 A, 8 Way TPN, built-in	8	24	32	8GB31852RC	15005.-	1
	40 A, 12 Way TPN, built-in	8	36	44	8GB31854RC	18015.-	1
	63 A, 4 Way TPN, built-in	8	12	20	8GB31860RC	14405.-	1
	63 A, 6 Way TPN, built-in	8	18	26	8GB31861RC	14855.-	1
	63 A, 8 Way TPN, built-in	8	24	32	8GB31862RC	16205.-	1
	63 A, 12 Way TPN, built-in	8	36	44	8GB31864RC	18310.-	1



Note:

* MRP - Maximum Retail Price

For Customized Solutions in Distribution Boards please Contact our sales Office

** Purchase MOQ for our authorised dealers is in multiples of standard packing, contact Siemens Sales Office for further details

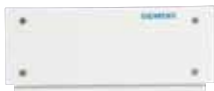
Wire Way Boxes & Modular Device Boxes

	Item Description	Incoming Slots (MW)	Outgoing Slots (MW)	Total Slots (MW)	Reference No	Unit MRP* ₹	Std. Pkg.** (Nos.)
Wire Way Boxes (WWB)							
	WWB for Flexi DB,8Mod	—	—	—	8GB9908FWWNT	1600.-	1/5
	WWB for Flexi DB,12Mod	—	—	—	8GB9912FWWNT	1790.-	1/5
	WWB for Flexi DB,16Mod	—	—	—	8GB9916FWWNT	2135.-	1/5
	WWB for Bus DB	—	—	—	8GB99BUSWWNT	2390.-	1/5
	WWB for Bus Plus DB	—	—	—	8GB99BPLUSWWNT	2590.-	1/5
Modular Device Boxes (MDB)							
	MDB for Flexi DB, 8Mod/Row	—	—	8	8GB9908FMDTC	1955.-	1/5
	MDB for Flexi DB,12Mod/Row	—	—	12	8GB9912FMDTC	2220.-	1/5
	MDB for Flexi DB,16Mod/Row	—	—	16	8GB9916FMDTC	2480.-	1/5
	MDB for Bus DB	—	—	12	8GB99BUSMBTC	2760.-	1/5
	MDB for Bus Plus DB	—	—	12	8GB99BPLUSMBTC	3005.-	1/5

Industrial plug & sockets

	Item Description	Total Slots (MW)	Reference No	Unit MRP* ₹	Std. Pkg.** (Nos.)
Plug & Socket, IP20 with provision for MCB mounting :					
	1 Phase 20A, 1P MCB	1	8GB0501RC	1575.-	1/20
	1 Phase 20A, 2P MCB	2	8GB0501SRC	1575.-	1/20
	3 Phase 32A, 3P MCB	3	8GB0502	3345.-	1/15
	3 Phase 32A, 3P+N MCB	4	8GB0502S	3345.-	1/15
	5 Pin (3P+N+PE) 3Phase 32A MCB 3P+N MCB	8	8GB050332	5280.-	1/5
	5 Pin (3P+N+PE) 3Phase 63A MCB 3P+N MCB	8	8GB050363	13760.-	1/5

Simbox WP

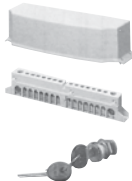







	Item Description	Total Slots (MW)	Reference No	Unit MRP* ₹	Std. Pkg.** (Nos.)
Simbox WP (IP65 DBs)					
	1 Row, 4Mod	4	8GB13710	4750.-	1
	1 Row 8Mod	8	8GB13711	6035.-	1
	1 Row 12Mod	12	8GB13712	10770.-	1
	1 Row 18Mod	18	8GB13713	13950.-	1
	2 Row 2 x 12Mod	24	8GB13722	17220.-	1
	2 Row, 2 x 18Mod	36	8GB13723	24285.-	1
	3 Row, 3 x 18Mod	54	8GB13733	42700.-	1
4 Row 4 x 18Mod	72	8GB13743	55950.-	1	
Accessories for Simbox WP					
	Coupling covers,12M		8GB20510	1555.-	1
	Coupling covers,18M		8GB20511	1740.-	1
	Insulated N/PE terminals, 8MW		8GB20520	2420.-	1
	Insulated N/PE terminals, 12MW		8GB20521	3705.-	1
	Insulated N/PE terminals, 18MW		8GB20522	5440.-	1
	Cylindrical security lock		8GB20550	4415.-	1

Note: * MRP - Maximum Retail Price

For Customized Solutions in Distribution Boards please Contact our sales Office

** Purchase MOQ for our authorised dealers is in multiples of standard packing, contact Siemens Sales Office for further details

Betagard Distribution Boards Accessories

	Item Description	Reference No	Unit MRP* ₹	Std. Pkg.** (Nos.)
Blanking Plate				
	0.5 MW	8GB9905	15.-	25
	1 MW	8GB9901	60.-	25
	1.5 MW	8GB9902	70.-	25
Insulated Shorting Links				
Single Phase Shorting Links for Shorting 1P MCBs				
For SPN and TPN PPI DB				
	5 Leg SP Shorting Link	8GB9905LSP	190.-	10
	7 Leg SP Shorting Link	8GB9907LSP	225.-	10
	9 Leg SP Shorting Link	8GB9909LSP	265.-	10
	11 Leg SP Shorting Link	8GB9911LSP	280.-	10
	13 Leg SP Shorting Link	8GB9913LSP	370.-	10
	15 Leg SP Shorting Link	8GB9915LSP	450.-	10
	17 Leg SP Shorting Link	8GB9917LSP	475.-	10
For TPN DB				
	4 Leg SP Shorting Link	8GB9904LSP	190.-	10
	6 Leg SP Shorting Link	8GB9906LSP	225.-	10
	8 Leg SP Shorting Link	8GB9908LSP	265.-	10
	10 Leg SP Shorting Link	8GB9910LSP	280.-	10
	12 Leg SP Shorting Link	8GB9912LSP	370.-	10
	14 Leg SP Shorting Link	8GB9914LSP	450.-	10
	16 Leg SP Shorting Link	8GB9916LSP	475.-	10
Two Phase, 1 meter long for shorting 2P MCBs (suitable for maximum of 28 nos. 2MW devices)				
	Shorting link without End caps, Can be cut and used.	8GB990SLLDP	4700.-	1
	End Caps for 2 pole Shorting Links	8GB990ECLDP	80.-	10
Three Phase, 1 meter long for shorting 3P MCBs (suitable for maximum of 19 nos. 3MW devices)				
	Shorting link without Enc caps, Can be cut and used.	8GB990SLLTP	5140.-	1
	End Caps for 3 pole Shorting Links	8GB990ECLTP	115.-	10
Three Phase + N, 1 meter long for shorting TPN MCBs (suitable for maximum of 14 nos. 4MW devices)				
	Shorting link without Enc caps, Can be cut and used.	8GB990SLLTPN	5430.-	1
	End Caps for 3 pole Shorting Links	8GB990ECLTPN	145.-	10
Neutral Terminals				
Neutral Terminals For 8GB0 and 8GB31 DBs (Along with Mounting Stands)				
	5 Way Neutral Link	8GB9905NL	205.-	10
	11 Way Neutral Link	8GB9911NL	305.-	10
	13 Way Neutral Link	8GB9913NL	350.-	10
	15 Way Neutral Link	8GB9915NL	390.-	10
Neutral Terminals For 8GB32 DBs (With Terminal Shroud and Cover)				
	Neutral Terminal 5 Holes	8GB9905NPE	225.-	10
	Neutral Terminal 11 Holes	8GB9911NPE	315.-	10
	Neutral Terminal 13 Holes	8GB9913NPE	370.-	10
	Neutral Terminal 15 Holes	8GB9915NPE	415.-	10
Earth Terminals				
	5 Way Earth Link	8GB9905EL	175.-	10
	11 Way Earth Link	8GB9911EL	295.-	10
	13 Way Earth Link	8GB9913EL	315.-	10
	15 Way Earth Link	8GB9915EL	370.-	10

Note: * MRP - Maximum Retail Price

** Purchase MOQ for our authorised dealers is in multiples of standard packing, contact Siemens Sales Office for further details



SIEMENS

Ingenuity for life

SENTRON

5SD7 Surge Protection Devices

Seamless and safe

Surge Protection Devices are available in the following types:

Type 1 - For incoming power supply panels, in buildings with lightning protection system. Must be accompanied by downstream Type 2 protector

Type 2 - For distribution panels located downstream of Type 1 protectors or in incoming supply panels in areas of low exposure to lightning strikes, where the building is not fitted with lightning protection system

Type 3 - Always installed downstream of Type 2 protection designed to protect sensitive equipment or equipment located more than 20m downstream of Type 2 SPD

www.siemens.co.in

Surge Protection Devices

For protection of equipment against Lightning and Switching surges

NEW

- Standard: IEC 61643-11 / EN 61643-11
- Type 1, Type 2 and Photovoltaic surge protection
- With Remote signaling contact
- Integrated SPD health indicator

Type 1: Lightning Surge Arresters

- Maximum continuous operating voltage U_c : 350V



Reference No.	Rated voltage	Pole	Module width	Total I_{imp} (10/350 μ s)	I_{max} (8/20 μ s)	Remote status	Unit LP* ₹
5SD74121RC	240V AC	1P+N	4	50kA	50kA	Yes	18335.-
5SD74141RC	240/415V AC	3P+N	8	100kA	50kA	Yes	35690.-

Type 2: Surge Arresters



Reference No.	Rated voltage	Pole	Module width	U_c	I_{max} (8/20 μ s)	Remote status	Unit LP* ₹
5SD74610RC	240V AC	1P	1	335V AC	20kA	No	3000.-
5SD74640RC	240/415V AC	3P+N	4	335V AC	40kA	No	8910.-

Surge Arresters for Photovoltaic application

On the DC side, over voltage protection is required for the inverters which can be ensured by using 5SD74836RC.

On the AC side, the over voltage protection can be ensured using surge arresters Type 2 (5SD7461-ORC/5SD7464-ORC)



Reference No.	Rated voltage	Pole	Module width	U_{cpv}	I_{max} (8/20 μ s)	Remote status	Unit LP* ₹
5SD74836RC	1170V DC	L+ and L-	3	1170V DC	40kA	No	5060.-

Note: Standard packing: 1 unit

*LP: List Price



Surge Protection Devices

For protection of equipment against Lightning and Switching surges

Type 1: Lightning Surge Arresters

For TN-S/ TT system

Lightning arresters, Type 1 requirement class B, U_c 350V Pluggable protective modules 4-pole, 3+1 circuit for TN-S and TT systems with remote display



Rated voltage U_N	Backup fuse rating	Protection level	Lightening impulse current $I_{mp}(10/350\mu s)$		Pole	Reference No.	Unit LP* ₹
			L-N or L-(PE), 1P/3P	N-PE			
240V AC	125A gL/gG	1.5-2.5kV	25kA	100kA	1P+N	5SD74121	Price on request
240/415V AC	125A gL/gG	1.5-2.5kV	25kA/75kA	100kA	3P+N	5SD74141	

For TN-C system

Lightning arresters, Type 1 requirement class B, U_c 350V Pluggable protective modules 3-pole, 3+0 circuit for TNC systems with remote display



Rated voltage U_N	Backup fuse rating	Protection level	Lightening impulse current $I_{mp}(10/350\mu s)$		Pole	Reference No.	Unit LP* ₹
			L-N or L-(PE), 1P/3P	N-PE			
240/415V AC	125A gL/gG	$\leq 1.5kV$	25kA/75kA	-	3P	5SD74131	56490.-

Type 2 : Surge Arresters

For TN-S/ TT system

Surge arrester Type 2 requirement class C, U_c :350V/260V (L-N/N-PE) Pluggable protective modules 4-pole, 3+1 circuit for TN-S and TT AC systems

Rated Discharge Surge Current $I_n=20kA$ SC capacity with backup fuse=25kA



Rated voltage U_N	Backup fuse rating	Protection level U_p	Rated discharge current I_n (8/20usec)		Pole	Remote signaling	Reference No.	Unit LP* ₹
			L-N or L-(PE), 1P/3P	N-PE				
240/415V	80A gL/gG	1.5-1.9kV	40kA	40kA	3P+N	No	5SD74640	Price on request
240/415V	80A gL/gG	1.5-1.9kV	40kA	40kA	3P+N	Yes	5SD74641	
240V	80A gL/gG	1.5-1.9kV	20kA	20kA	1P+N	No	5SD74220	
240V	80A gL/gG	1.5-1.9kV	20kA	20kA	1P+N	Yes	5SD74221	

For TN-C system

Surge arrester Type 2 requirement class C, U_c :350V Pluggable protective modules 3-pole, 3+0 circuit for TNC systems



Rated voltage U_N	Backup fuse rating	Protection level U_p	Maximum discharge surge current I_{max}	Pole	Remote signaling	Reference No.	Unit LP* ₹
			L-N or L-(PE)N, 1P				
240/415V	80A gL/gG	$\leq 1.5kV$	40kA	3P	No	5SD74630	25755.-
240/415V	80A gL/gG	$\leq 1.5kV$	40kA	3P	Yes	5SD74631	17225.-

L - Line, N - Neutral, PE - Protective Earth

Note: Standard packing: 1unit

* LP : List Price

Surge Protection Devices

For protection of equipment against Lightning and Switching surges

Type 3 : Surge Arresters

For TN-S/ TT system

Type 3 surge arrester requirement class D Rated voltage U_N 230 V U_C 253V, 4-pole for 3-phase power supply

Max. continuous operating voltage $U_c=264V/335V$ AC(2P/4P)



5SD74321 5SD74341

Rated voltage U_N	Rated current	Backup fuse rating	Protection level	Rated Discharge surge current I_n	Pole	Reference No.	Unit LP* ₹
230/400 AC	26A	25A gL/gG	< 1.5kV	3kA	2P	5SD74321	12045.-

Surge arresters for photovoltaic application

Due to the combination of three power varistors, the overvoltage protection required for the inverters is implemented on the DC side. On the AC side, the overvoltage protection can be ensured using surge arresters type 2 (5SD7422-/5SD7424-)



5SD74836

Rated voltage U_N	Rated discharge current	Protection level U_p	Lightning Impulse current (L-N/L-(PE)N)	Max. discharge current	Pole	Remote signaling	Reference No.	Unit LP* ₹
1000V DC	15kA	$\leq 3.5kV$	$\leq 5kA$	40kA	3P	No	5SD74836	Price on request

Replacement Plug



SPD Type	Type	Connection	Reference No.	Unit LP* ₹
5SD74121	Type 1	L-N	5SD74181	19940.-
5SD74131				
5SD74141				
5SD74121	Type 2	N-PE	5SD74180	13245.-
5SD74131				
5SD74141				
5SD7463-0/1	Type 2	L-N	5SD74681	5205.-
5SD7464-0/1				
5SD7464-0/1				
5SD7422-0/1	Type 2	L-N	5SD74281	4015.-
5SD7422-0/1		N-PE	5SD74280	7600.-
5SD7483-6	PV	-	5SD74983	Price on request

* Also available Type 1+ Type 2 and Type 1/2 Compact SPDs for protection against overvoltages from Lightning strikes as well as by switching operations in network

Note:

Standard packing: 1unit

* LP - List Price

SIEMENS

Ingenuity for life



SENTRON

Modular Devices

For efficient control and monitoring

- 7LF time switch - Digital and Analog timers for all applications; available in Mini, Top, Profi, Astro, Expert and Expert GPS variants
- 5TT5 insta contactors – For all control applications; also with Manual/Automatic switching indicator
- DIN mounted phase indicators, monitoring relays and measuring devices for final distribution circuits
- Twilight Switch for Automatic Street Light Control

www.siemens.co.in

Modular Devices

	Item Description	Rated Current I _n (A)	MW#	Reference No	Unit LP* ₹	Std. Pkg.** (Nos.)
Changeover switches Standards: IEC 60947-3/DIN EN 60947-3						
	1C/O, 230V	20	1	5TE8161	1760.-	1/10
	2C/O, 400V	20	1	5TE8162	3215.-	1/10
	Group switch, center position, 2C/O, 400V	20	1	5TE8142	3710.-	1/10
Insta Contactors Standards: EN 60947-4-1, EN 60947-5-1						
	2NO contacts, 230Vac	20	1	5TT58000	2795.-	1/5
	3NO+1NC contacts, 230Vac/220Vdc (1NC contact rated for 30A)	40	3	5TT58410	7650.-	1/5
	3NO+1NC contacts, 24Vac/24Vdc (1NC contact rated for 30A)	40	3	5TT58412	7680.-	1/5
	4NO contacts, 230Vac/220Vdc	40	3	5TT58400	7705.-	1/5
	4NO contacts, 24Vac/24Vdc	40	3	5TT58402	7570.-	1/5
	3NO+1NC contacts, 230Vac/220Vdc (1NC contact rated for 30A)	63	3	5TT58510	10650.-	1/5
	3NO+1NC contacts, 24Vac/24Vdc, (1NC contact rated for 30A)	63	3	5TT58512	11260.-	1/5
	4NO contacts, 230Vac/220Vdc	63	3	5TT58500	9765.-	1/5
4NO contacts, 24Vac/24Vdc	63	3	5TT58502	10290.-	1/5	
Insta Contactors Manual / Automatic with Switching Indicator Standards: IEC60947-4-1, IEC60947-5-1						
	2NO contacts, 230Vac	20	1	5TT58006	3720.-	1/5
	1NO+1NC contacts, 230Vac	20	1	5TT58016	5605.-	1/5
	4NO contacts, 230Vac	25	2	5TT58306	5270.-	1/5
	4NO contacts, 400Vac	40	3	5TT58406	11600.-	1/5
	4NO contacts, 400Vac	63	3	5TT58506	14705.-	1/5
Accessories						
	Control Switch with 1 Make and 1 Break Contact For AC 230V/400V For 5TT58 and 5TT50			5TT59101	3180.-	1/10





Note:

* LP - List Price # 1MW (Module Width) = 18mm

** Purchase MOQ for our authorised dealers is in multiples of standard packing, contact Siemens Sales Office for further details



Modular Devices



	Item Description	Rated Current I _n (A)	MW#	Reference No	Unit LP* ₹	Std. Pkg.** (Nos.)
Twilight switch						
	Twilight Switch with light sensor 230 V, 50/60 Hz, 1MW, 16A			7LQ2300	Price on request	1
Voltage Relays Standards: IEC 60255, DIN VDE 0435-303						
	Voltage relay for undervoltage monitoring of 1,2,3 phases against N with phase failure detection, Switching thresholds 0.7-0.9xV, not adjustable; 2 C/O contacts, 4A, 230/400Vac	4	2	5TT3402	12270.-	1
	Voltage relay for undervoltage monitoring of 1,2,3 phases against N, short time failure detection with phase failure detection and N conductor monitoring, Switching thresholds 0.8-0.85xV, not adjustable; 2 C/O contacts, 230/400Vac	4	2	5TT3407	20430.-	1
	Voltage relay for over and undervoltage monitoring of 3 phases against N with asymmetry, reverse voltage and phase failure detection with N conductor monitoring and adj. Time delay of 0.1 to 20s, Switching thresholds: U/voltage 0.7-1.1xV, 4% hysteresis, adjustable, O/voltage 0.9-1.1xV, 4% hysteresis, adjustable; 2 C/O contacts, 230/400Vac	4	2	5TT3408	23520.-	1
RYG 3 phase indicator in 1MW						
	3 phase indicator (all with green color cap)		1	5TE5802	3165.-	1/10
	3 phase indicator (red/yellow/green)		1	5TE5803	2695.-	1/10
	Transparent cap (1 set = 3 items, R, Y, G lens)			5TG8070	875.-	1/10
Power ON Indicator (Economy Version) 230 Vac, 1 Phase						
	Light indicators for max. cable length up to 5 m with 1 red lamp		1	5TE5800	1675.-	1/12
	Light indicators for max. cable length up to 250 m with 1 red lamp		1	5TE5804	1335.-	1/12
	Transparent cap (Red)			5TG8061	125.-	5
	Transparent cap (Green)			5TG8062	125.-	5
	Transparent cap (Yellow)			5TG8063	125.-	5
	Transparent cap (Blue)			5TG8064	125.-	5
Fuse Monitor						
	Fuse monitors with transparent caps for all low voltage fuse systems, 230Vac	4	2	5TT3170	9625.-	1

Note:

* LP - List Price

1MW (Module Width) = 18mm

Modular Devices

	Item Description	Rated Current I_n (A)	MW [#]	Reference No	Unit LP* ₹	Std. Pkg.** (Nos.)
Time Switches (Digital)						
	Mini digital, daily/weekly program, 100 hours reserve, 230Vac	16	1	7LF45015	7170.-	1
	Yearly time switch top digital 230V, 1 channel	16	2	7LF45110	8575.-	1
	Yearly time switch top digital 230V, 2 channel	16	2	7LF45120	18655.-	1
	Weekly time switch profi digital 230V, 1 channel	16	2	7LF45210	17380.-	1
	Weekly time switch profi digital 230V, 2 channel	16	2	7LF45220	22470.-	1
	Weekly time switch astro digital 230V, 1 channel	16	2	7LF45310	15535.-	1
	Weekly time switch astro digital 230V, 2 channel	16	2	7LF45320	40270.-	1
Time Switches (Mechanical) Standards: EN 60730-1						
 7LF53005	Quartz time switch Day 1 NO 230V/50-60Hz 1 MW with power reserve	16	1	7LF53011	5870.-	1
	Synchronous time switches without power reserve, for DIN rail mounting, day disk, 1CO, 230V AC	16	3	7LF53005	3240.-	1
	Quartz-clock time switches with power reserve for DIN rail mounting, day disk, 1CO, 230V AC	16	3	7LF53016	6265.-	1
	Quartz-clock time switches with power reserve for wall mounting, day disk, 1CO, 250Vac	16	—	7LF53050	9370.-	1
	Synchronous time switches without power reserve, for wall mounting, day disk, 1CO, 250Vac	16	—	7LF53010	5715.-	1
Accessories for Digital Time Switches						
	USB adapter and software			7LF49410	26425.-	1
	Data key profi, astro			7LF49411	2690.-	1

Note:

* LP - List Price

1MW (Module Width) = 18mm

** Purchase MOQ for our authorised dealers is in multiples of standard packing, contact Siemens Sales Office for further details





SIEMENS

Ingenuity for life

3VM moulded case circuit breaker

Efficient. Powerful.

- Rated current: 16A to 630A
- 1 pole[^], 2 pole[^], 3 pole & 4 pole versions
- Breaking capacity: 16kA to 55kA
- Thermal magnetic trip unit (FTFM, ATFM, AM, FM)
- Switch disconnectors
- Common Internal accessories for the entire range
- Knowledge Manager (QR Code)

www.siemens.co.in

Moulded Case Circuit Breakers[®] 3VT1, 2, 3 MCCBs

3VT1#, 415 V AC, 50 Hz MCCB, Thermal Magnetic Release for line protection (Fixed Overload & Fixed Short Circuit Settings)

	Rated Current, A	3VT1 3 pole Reference No.	Unit MRP* ₹	3VT1 4 pole Reference No	Unit MRP* ₹	Std. Pkg. (Nos.)
	40	3VT1704-2DA36-0AA0	-	3VT1704-2EA46-0AA0	-	1
	63	3VT1706-2DA36-0AA0	-	3VT1706-2EA46-0AA0	-	1
	80	3VT1708-2DA36-0AA0	-	3VT1708-2EA46-0AA0	-	1
	100	3VT1710-2DA36-0AA0	-	3VT1710-2EA46-0AA0	-	1
	125	3VT1712-2DA36-0AA0	-	3VT1712-2EA46-0AA0	-	1
	160	3VT1716-2DA36-0AA0	-	3VT1716-2EA46-0AA0	-	1

(Adjustable Overload & Adjustable Short Circuit Settings)

	Rated Current, A	3VT1 3 pole Reference No.	Unit MRP* ₹	3VT1 4 pole Reference No	Unit MRP* ₹	Std. Pkg. (Nos.)
	16	3VT1701-2DC36-0AA0	-	3VT1701-2EC46-0AA0	-	1
	25	3VT1792-2DC36-0AA0	-	3VT1792-2EC46-0AA0	-	1
	32	3VT1703-2DC36-0AA0	-	3VT1703-2EC46-0AA0	-	1
	40	3VT1704-2DC36-0AA0	-	3VT1704-2EC46-0AA0	-	1
	63	3VT1706-2DC36-0AA0	-	3VT1706-2EC46-0AA0	-	1
	80	3VT1708-2DC36-0AA0	-	3VT1708-2EC46-0AA0	-	1
	100	3VT1710-2DC36-0AA0	-	3VT1710-2EC46-0AA0	-	1
	125	3VT1712-2DC36-0AA0	-	3VT1712-2EC46-0AA0	-	1
	160	3VT1716-2DC36-0AA0	-	3VT1716-2EC46-0AA0	-	1

3VT2/3, 415 V AC, 50 Hz MCCB, Microprocessor based Release for line protection (Adjustable Overload & Adjustable Short Circuit Settings)

Rated Current, A	3VT2/3 (Base Unit) Reference No. 3 pole	Unit LP* ₹	3VT2/3 (Base Unit) Reference No. 4 pole	Unit LP* ₹	ETU Reference No.	Unit LP* ₹
3VT2 & 3, 36kA						
200A	3VT2725-2AA36-0AA0	-	3VT2725-2AA46-0AA0	-	3VT9225-6AC00	-
250A	3VT2725-2AA36-0AA0	-	3VT2725-2AA46-0AA0	-	3VT9225-6AC00	-
400A	3VT3763-2AA36-0AA0	-	3VT3763-2AA46-0AA0	-	3VT9340-6AC00	-
630A	3VT3763-2AA36-0AA0	-	3VT3763-2AA46-0AA0	-	3VT9363-6AC00	-

Accessories	3VT1 Reference No.	Unit LP* ₹	3VT2 Reference No	Unit LP* ₹	3VT3 Reference No.	Unit LP* ₹
Auxiliary Switch [§]	3VT9100-2AB10	-	3VT9300-2AC10	-	3VT9300-2AC10	-
Alarm Switch [^]	3VT9100-2AH10	-	3VT9300-2AD10	-	3VT9300-2AD10	-
Door mounted Rotary handle	3VT9100-3HQ00	-	3VT9200-3HQ00	-	3VT9300-3HQ00	-

Note : The ordering of Microprocessor based MCCB's above 200A includes ordering of Base Unit + Electronic Trip Unit (ETU) separately

§ Auxiliary switch for 3VT1 is 1 C/O & for 3VT2 ,3 is 1NO; ^ Alarm switch for 3VT1 is 1 C/O & for 3VT2 ,3 is 1NC;

3VT1 MCCBs are suitable for mounting in Beta Bus Plus Distribution Boards

@ Kindly refer latest Power Distribution Products Price List for prices

Raja⁺ DOL Starters[®] 3TW Direct On Line Starters



Ue: 415V, 3ph, 50Hz DOL Starter in sheet steel housing, including bimetal relay with single phasing protection

	Motor rating		Relay Range A	Reference No ¹⁾	Unit MRP* ₹	Std. Pkg. (Nos.)
	HP	kW				
	0.33	0.25	0.63-1	3TW72 91-1A.64	-	1
	0.75	0.55	1-1.6	3TW72 91-1A.66	-	1
	1	0.75	1.6-2.5	3TW72 91-1A.68	-	1
	1.5	1.1	2-3.2	3TW72 91-1A.69	-	1
	2	1.5	3-2.5	3TW72 91-1A.71	-	1
	3	2.2	4-6.3	3TW72 91-1A.72	-	1
	5	3.7	6.3-10	3TW72 91-1A.74	-	1
	-	-	8-12.5	3TW72 91-1A.75	-	1
	7.5	5.5	10-16	3TW72 91-1A.77	-	1
	10	7.5	12.5-20	3TW72 91-1A.78	-	1

1) Enter code for coil voltage, 50Hz (B for 200-400V, W for 415V)

@ Kindly refer latest Motor Control Products Price List for prices

* MRP - Maximum Retail Price LP - List Price

Switch disconnecter fuse[@] Superswitch 3KL8 in open execution TPN

Switch Disconnector fuse: 3KL8 for power distribution (in Open Execution TPN)[^]

	Rated current I _e @ 690V AC 50Hz	SDF suitable for DIN type HRC Fuses	SDF suitable for BS type HRC Fuses	SDF suitable for cylindrical type HRC Fuses	Std. pkg. (nos.)
	20A	3KL8111-5TA00	3KL8111-5TJ00	3KL8111-5TC00	1
	32A	3KL8121-5TA00	3KL8121-5TJ00	3KL8121-5TC00	1
	63A	3KL8151-5TA00	3KL8151-5TJ00	3KL8151-5TC00	1
	100A	3KL8211-5TA00	3KL8211-5TJ00	-	1
	125A	3KL8221-5TA00	3KL8221-5TJ00	-	1
	160A	3KL8231-5TA00	3KL8231-5TJ00	-	1
	200A	3KL8311-5UA00	3KL8311-5UJ00	-	1
	250A	3KL8321-5UA00	3KL8321-5UJ00	-	1
	315A	3KL8331-5UA00	3KL8331-5UJ00	-	1
	400A [§]	3KL8341-5UA00	3KL8341-5UJ00	-	1
	500A	3KL8411-5UA00	3KL8411-5UJ00	-	1
	630A	3KL8421-5UA00	3KL8421-5UJ00	-	1
	800A [§]	3KL8431-5UA00	3KL8431-5UJ00	-	1

[^] TPN is 3 Pole with neutral link

Selection table for SS Housing for 3KL8



	Rated current I _e (A)	Reference No	Unit MRP* ₹	Std. Pkg. (Nos.)
	3KL81 (20A - 63A)	3KX8235-4AC	-	1
	3KL82 (100A - 160A)	3KX8235-4AC	-	1
	3KL83 (200A - 400A)	3KX8345-4AC	-	1
	3KL84 (500A - 800A)	3KX8435-4AC	-	1

Rated current I _e (A)	Gland box Reference No.	Unit MRP* ₹	Gland Plate Reference No.	Unit MRP* ₹	Std Pkg. (Nos.)
3KL81(20A-63A)	3KX8235-4DC	-	3KX8235-4GC	-	1
3KL82(100A-160A)	3KX8235-4DC	-	3KX8235-4GC	-	1
3KL83(200A-400A)	3KX8345-4DC	-	3KX8345-4GC	-	1
3KL84(500A-800A)	3KX8435-4DC	-	3KX8435-4GC	-	1

LV HRC Fuses[@]

DIN Type Fuse



Rated voltage: 500 V AC

	Size	Rated current A	Reference No	Unit MRP* ₹	Std. Pkg. (Nos.)
	000	2	3NA7 802-ORC	-	1/6
		4	3NA7 804-ORC	-	
		6	3NA7 801-ORC	-	
		10	3NA7 803-ORC	-	
		16	3NA7 805-ORC	-	
		20	3NA7 807-ORC	-	
		25	3NA7 810-ORC	-	
		32	3NA7 812-ORC	-	
		40	3NA7 817-ORC	-	
		50	3NA7 820-ORC	-	
	00	63	3NA7 822-ORC	-	
		80	3NA7 824-ORC	-	
		100	3NA7 830-ORC	-	
		125	3NA7 832-ORC	-	
	1	160	3NA7 836-ORC	-	1/3
		50	3NA7 120-ORC	-	
		63	3NA7 122-ORC	-	
		80	3NA7 124-ORC	-	
		100	3NA7 130-ORC	-	
		125	3NA7 132-ORC	-	
		160	3NA7 136-ORC	-	
		200	3NA7 140-ORC	-	
		224	3NA7 142-ORC	-	
		250	3NA7 144-ORC	-	

[#] 400 & 800A fuses - Rated voltage at 415 V AC
[§]- AC23A @ 550V AC

Note: * MRP - Maximum Retail Price

[@] Kindly refer latest Power Distribution Products Price List for prices

	Size	Rated current A	Reference No	Unit MRP* ₹	Std. Pkg. (Nos.)
	2	200	3NA7 240-ORC	-	1/3
		250	3NA7 244-ORC	-	
		315	3NA7 252-ORC	-	
		400 [‡]	3NA7 260-ORC	-	
	3	315	3NA3 352-ORC	-	1/3
		400	3NA3 360-ORC	-	
		500	3NA3 365-ORC	-	
		630	3NA3 372-ORC	-	
		800 [‡]	3NA3 375-ORC	-	



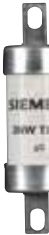

BS Fuses

	Type	Rated current A	Reference No	Unit MRP* ₹	Std. Pkg. (Nos.)
	Offset Tag	2	3NW TIA2	-	20
		4	3NW TIA4	-	
		6	3NW TIA6	-	
		10	3NW TIA10	-	
		16	3NW TIA16	-	
		20	3NW TIA20	-	
		25	3NW TIA25	-	
		32	3NW TIA32	-	
		40	3NW TIS40	-	
		50	3NW TIS50	-	
		63	3NW TIS63	-	

Available till stocks last

Betagard Circuit Breakers 5SY7, with D Characteristics

- Standards: IEC/EN 60947-2
- Voltage: Un 230/400V AC, 50....60Hz can be used in systems upto 60V DC for 1P and 110V DC for 2P
- Breaking capacity: 15kA as per IEC/EN 60947-2



15000A	Rated Current I_n (A)	MW#	Reference No	Unit MRP* ₹	Std. Pkg.** (Nos.)
	1P, 230/400V AC	1	5SY71058CC	570.-	1/12
	1		5SY71018CC	570.-	1/12
	2		5SY71028CC	570.-	1/12
	3		5SY71038CC	570.-	1/12
	4		5SY71048CC	570.-	1/12
	6		5SY71068CC	495.-	1/12
	8		5SY71088CC	495.-	1/12
	10		5SY71108CC	495.-	1/12
	13		5SY71138CC	495.-	1/12
	16		5SY71168CC	495.-	1/12
	20		5SY71208CC	495.-	1/12
	25		5SY71258CC	495.-	1/12
	32		5SY71328CC	495.-	1/12
	40		5SY71408CC	890.-	1/12
	50		5SY71508CC	900.-	1/12
63		5SY71638CC	900.-	1/12	
	2P, 400V AC	2	5SY72058CC	1470.-	1/6
	1		5SY72018CC	1470.-	1/6
	2		5SY72028CC	1470.-	1/6
	3		5SY72038CC	1470.-	1/6
	4		5SY72048CC	1470.-	1/6
	6		5SY72068CC	1120.-	1/6
	8		5SY72088CC	1120.-	1/6
	10		5SY72108CC	1120.-	1/6
	13		5SY72138CC	1120.-	1/6
	16		5SY72168CC	1120.-	1/6
	20		5SY72208CC	1120.-	1/6
	25		5SY72258CC	1120.-	1/6
	32		5SY72328CC	1120.-	1/6
	40		5SY72408CC	1945.-	1/6
	50		5SY72508CC	1945.-	1/6
63		5SY72638CC	1945.-	1/6	
	3P, 400V AC	3	5SY73058CC	2250.-	1/4
	1		5SY73018CC	2250.-	1/4
	2		5SY73028CC	2250.-	1/4
	3		5SY73038CC	2250.-	1/4
	4		5SY73048CC	2250.-	1/4
	6		5SY73068CC	1780.-	1/4
	8		5SY73088CC	1780.-	1/4
	10		5SY73108CC	1780.-	1/4
	13		5SY73138CC	1780.-	1/4
	16		5SY73168CC	1780.-	1/4
	20		5SY73208CC	1780.-	1/4
	25		5SY73258CC	1780.-	1/4
	32		5SY73328CC	1780.-	1/4
	40		5SY73408CC	3030.-	1/4
	50		5SY73508CC	3030.-	1/4
63		5SY73638CC	3030.-	1/4	
	4P, 400V AC	4	5SY74058CC	3125.-	1/3
	1		5SY74018CC	3125.-	1/3
	2		5SY74028CC	2885.-	1/3
	3		5SY74038CC	2885.-	1/3
	4		5SY74048CC	2885.-	1/3
	6		5SY74068CC	2355.-	1/3
	8		5SY74088CC	2355.-	1/3
	10		5SY74108CC	2355.-	1/3
	13		5SY74138CC	2355.-	1/3
	16		5SY74168CC	2355.-	1/3
	20		5SY74208CC	2355.-	1/3
	25		5SY74258CC	2355.-	1/3
	32		5SY74328CC	2355.-	1/3
	40		5SY74408CC	3795.-	1/3
	50		5SY74508CC	3795.-	1/3
63		5SY74638CC	3795.-	1/3	

Available till stocks last



Available till stocks last

Betagard Circuit Breakers 5SY5, DC with C Characteristics

- Standards: IS/IEC 60947-2
- Voltage: 220V DC/1P & 440VDC/2P
- Breaking capacity: 10kA as per IS/IEC 60947-2

10000A	Rated Current I_n (A)	MW#	Reference No	Unit MRP* ₹	Std. Pkg.** (Nos.)
1P, 220V DC 	0.5	1	5SY51057CC	795.-	1/12
	1		5SY51017CC	795.-	1/12
	2		5SY51027CC	860.-	1/12
	3		5SY51037CC	860.-	1/12
	4		5SY51047CC	860.-	1/12
	6		5SY51067CC	730.-	1/12
	8		5SY51087CC	730.-	1/12
	10		5SY51107CC	730.-	1/12
	13		5SY51137CC	730.-	1/12
	16		5SY51167CC	730.-	1/12
	20		5SY51207CC	730.-	1/12
	25		5SY51257CC	730.-	1/12
	32		5SY51327CC	730.-	1/12
	40		5SY51407CC	1090.-	1/12
50		5SY51507CC	1090.-	1/12	
63		5SY51637CC	1090.-	1/12	
2P, 440V DC 	0.5	2	5SY52057CC	1735.-	1/6
	1		5SY52017CC	1735.-	1/6
	2		5SY52027CC	1735.-	1/6
	3		5SY52037CC	1735.-	1/6
	4		5SY52047CC	1735.-	1/6
	6		5SY52067CC	1525.-	1/6
	8		5SY52087CC	1525.-	1/6
	10		5SY52107CC	1525.-	1/6
	13		5SY52137CC	1525.-	1/6
	16		5SY52167CC	1525.-	1/6
	20		5SY52207CC	1525.-	1/6
	25		5SY52257CC	1525.-	1/6
	32		5SY52327CC	1525.-	1/6
	40		5SY52407CC	2240.-	1/6
50		5SY52507CC	2240.-	1/6	
63		5SY52637CC	2240.-	1/6	

Betagard Distribution Boards MB DBs

	Item Description	Incoming Slots (MW)	Outgoing Slots (MW)	Total Slots (MW)	Reference No	Unit MRP* ₹	Std. Pkg.** (Nos.)
Betagard MB (Ivory White):							
	1Row, 6Mod	2	4	6	8GB31810RC01	1880.-	1/10
	1Row, 8Mod	2	6	8	8GB31811RC01	2190.-	1/10
	1Row, 10Mod	2	8	10	8GB31812RC01	2430.-	1/10
	1Row, 12Mod	2	10	12	8GB31813RC01	2585.-	1/10
	1Row, 14Mod	2	12	14	8GB31814RC01	2740.-	1/10
	1Row, 16Mod	2	14	16	8GB31815RC01	3285.-	1/10
	Betagard MB (Metallic Grey):						
	1Row, 6Mod	2	4	6	8GB31810RC02	1960.-	1/10
	1Row, 8Mod	2	6	8	8GB31811RC02	2275.-	1/10
	1Row, 10Mod	2	8	10	8GB31812RC02	2585.-	1/10
	1Row, 12Mod	2	10	12	8GB31813RC02	2740.-	1/10
	1Row, 14Mod	2	12	14	8GB31814RC02	2895.-	1/10
	1Row, 16Mod	2	14	16	8GB31815RC02	3445.-	1/10
	Betagard MB (Metallic Carbon):						
	1Row, 6Mod	2	4	6	8GB31810RC03	1960.-	1/10
	1Row, 8Mod	2	6	8	8GB31811RC03	2275.-	1/10
	1Row, 10Mod	2	8	10	8GB31812RC03	2585.-	1/10
	1Row, 12Mod	2	10	12	8GB31813RC03	2740.-	1/10
	1Row, 14Mod	2	12	14	8GB31814RC03	2895.-	1/10
	1Row, 16Mod	2	14	16	8GB31815RC03	3445.-	1/10

Discontinued Products

Betagard Residual Current Circuit Breakers 5SM3

Reference No.	Reference No.	Reference No.	Reference No.
5SM33120RC	5SM33126RC	5SM33126RC01	5SM33424RC
5SM34120RC	5SM34126RC	5SM33146RC01	5SM36424RC
5SM36120RC	5SM36126RC		5SM33444RC
5SM33140RC	5SM33146RC	5SM33166RC01	5SM36444RC
5SM34140RC	5SM34146RC	5SM36166RC01	5SM33464RC
5SM36140RC	5SM36146RC		5SM36464RC
		5SM33426RC01	5SM37464RC
5SM33160RC	5SM33166RC	5SM33446RC01	5SM33474RC
5SM34160RC	5SM34166RC	5SM36446RC01	5SM36474RC
5SM36160RC	5SM36166RC	5SM33466RC01	5SM37474RC
5SM33170RC	5SM33176RC	5SM36466RC01	
5SM34170RC	5SM34176RC	5SM36476RC01	5SM36465RC
5SM36170RC	5SM36176RC		5SM37465RC
		5SM36148RC	5SM36475RC
5SM33420RC	5SM33426RC	5SM34168RC	
5SM34420RC	5SM34426RC	5SM36168RC	5SM33180KK
5SM36420RC	5SM36426RC	5SM36178RC	5SM34180KK
5SM33440RC	5SM33446RC		5SM36180KK
5SM34440RC	5SM34446RC	5SM34448RC	5SM33150KK
5SM36440RC	5SM36446RC	5SM36448RC	5SM34150KK
5SM33460RC	5SM33466RC	5SM34468RC	5SM36150KK
5SM34460RC	5SM34466RC	5SM36468RC	
5SM36460RC	5SM36466RC	5SM36458RC	5SM33186KK
5SM33470RC	5SM33476RC	5SM37458RC	5SM34186KK
5SM34470RC	5SM34476RC		5SM36186KK
5SM36470RC	5SM36476RC		5SM33156KK
			5SM34156KK
			5SM36156KK

Betagard Accessories

Reference No.	Reference No.
5SW3300	5ST38208
5SW3330	5ST38211

Modular Devices

Reference No.	Reference No.
7KT9010	5TT3410
7KT9011	5SD74341
7KT1110	7LF44440
7KT1120	7LF49402

Terms and Conditions

Maximum Retail Price (MRP) / List Price (LP) is subject to revision without prior notice.

The company reserves the right to supply goods at its works or godown at its discretion.

The minimum order size for non-stock items (items not marked with ■) is 50 Nos. for each item or ₹ 50,000/- per item.

Export control regulation - retention clause: The fulfillment of the agreement on Siemens part is subject to the provision that this shall not be prevented by implements on the grounds of national and international legal requirements, in particular export control provision.

Stock items

The normal stock items (indicated by ■) are subject to change without prior notice.

Note

- This supercedes all previous Price Lists.
- List Prices (LPs) mentioned are exclusive of all taxes.
- Maximum Retail Prices (MRPs) mentioned in the publication are maximum recommended selling prices.
- Invoice amount not to exceed MRP
- Invoice amount = MRP (less) applicable discount + applicable GST %
- For receiving material in factory sealed packing, we request you to order in multiples of the indicated standard packing quantity.

Ask your nearest Siemens partners to include you in our mailing list.

Always make your purchases only from our authorised dealers. Details available with our sales office/territory managers.



7KT PAC1200

Multichannel current measuring system
For flexible multichannel monitoring in final
distribution

Current Sensors

- Versions: 40 A, 63 A

Sensor Bar

- Versions available for 3, 6, 9, 12

Data Manager

- Connection of up to 96 sensors (40A/63A)
- DIN rail installation (4MW)

Communication/ Software:

- Modbus TCP/ IP
- Simple system onfiguration via web server
- Easy access to energy data with mobile app (iOS/Android)

*For more details, contact nearest Siemens Sales Office



- Modbus TCP/IP communication
- Simple configuration of system via powerconfig v3.6 and web server
- Visualization of consumption via Webserver and Mobile App (Android /iOS)

fast

- Flexible sensor bars and current sensors to record up to 96 circuits in one system
- Current sensors simply plug onto the sensor bars, eliminating extensive wiring

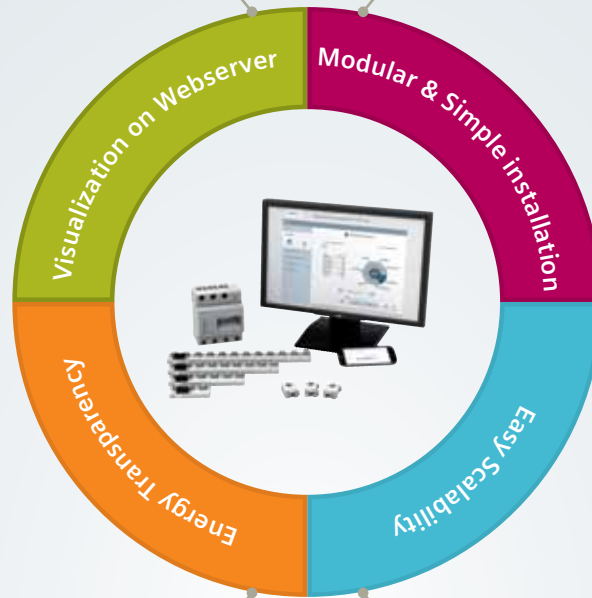

**plug
and
play**

- Targeted detection of power guzzlers
- Simultaneous display of power consumption and costs
- Ensures optimal power monitoring



- Easy to Upgrade
- Scale up the system without any interruption or cumbersome wiring



Easy



Transparent



Cost-efficient



Relevant Standards

Title	IS	IEC	Products							
			MCB		RCCB		RCBO	DB	AFDD	SPD
			5SL4/6/7	5SL5	5SV	5SM	5SU1	8GB	5SM6	5SD7
Electric Installations – MCBs for Building Installations and Similar Purposes Part 1: MCBs for AC Systems	IS 60898-1	IEC 60898-1	✓	–	–	–	–	–	–	–
Low-voltage switchgear and controlgear Part 2: Circuit-breakers	IS 60947-2	IEC 60947-2	–	✓	–	–	–	–	–	–
Residual Current Operated Circuit-Breakers for Household and Similar Uses, Part 1: Circuit-Breakers Without Integral Overcurrent Protection (RCCBs)	IS 12640-1	IEC 61008-1	–	–	✓	✓	–	–	–	–
Residual Current Operated Circuit-Breaking for Household and Similar Uses, Part 2: Circuit-Breakers with Integral Overcurrent Protection (RCBOs)	IS 12640-2	IEC 61009-1	–	–	–	–	✓	–	–	–
General requirements for arc fault detection devices	–	IEC 62606	–	–	–	–	–	–	✓	–
Low-voltage switchgear and controlgear assemblies, Part 2: Power switchgear and controlgear assemblies	–	IEC 61439-1/3	–	–	–	–	–	✓	–	–
Surge protective devices connected to low-voltage power systems	–	IEC 61643-11	–	–	–	–	–	–	–	✓



Degree of Protection

First digit: Protection against solid foreign objects		Second digit: Protection against ingress of water	
	0 No protection		0 No protection
	1 Protected against solid objects up to 50mm (e.g. hand)		1 Protection against vertically falling drops of water (e.g. condensation)
	2 Protected against solid objects up to 12mm diameter (e.g. finger)		2 Protection against direct sprays of water up to 15 degrees from vertical
	3 Protected against solid objects up to 2.5mm diameter (e.g. screwdriver)		3 Protection against direct sprays of water up to 60 degrees from vertical
	4 Protected against solid objects up to 1mm diameter (e.g. wire)		4 Protection against water sprayed from all directions, limited ingress permitted
	5 Protected against dust: limited ingress permitted, no harmful deposit.		5 Protected against low-pressure jets of water from all directions, limited ingress permitted
	6 Totally protected against dust		6 Protected against strong jets of water from all directions, limited ingress permitted (e.g. water from heavy seas on a ship's deck)
			7 Protected against the effect of temporary immersion (30 min) between 15cm and 1m
			8 Protected against long period of immersion under pressure
			9 Protected against high pressure, high temperature jets of water from multiple directions

IP 6 8



Installation Guideline for RCCB

RCCB suitability for various distribution networks.

Betagard RCCBs can be used in all 3 distribution network types viz. TN, TT & an IT network system. 4 pole RCCBs can also be used in 3 pole supply networks by adhering to installation guidelines. In this case, connection must be at terminals 1, 3 and 5 and 2, 4 and 6.

The function of the test equipment is only ensured if a jumper is fitted between terminals 3 and N.

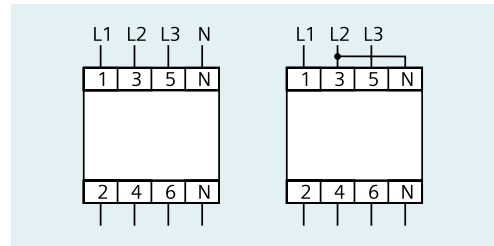

Types and waveform

					6 mA	10 mA		
Type AC		■	-	-	-	-	-	-
Type A		■	■	■	■	-	-	-
Type F		■	■	■	■	■	■	-
Type B		■	■	■	■	■	■	■
Type B+		■	■	■	■	■	■	■

Version

SIGRES	with active condensation protection for use in severe ambient conditions
[G] / [K]	super-resistant, 10 ms short-term delayed devices with increased immunity to false triggering due to transient disruptions
[S]	as an upstream group switch for selective shutdown against downstream RCCBs



Installation locations for Surge Protection Devices (SPDs)

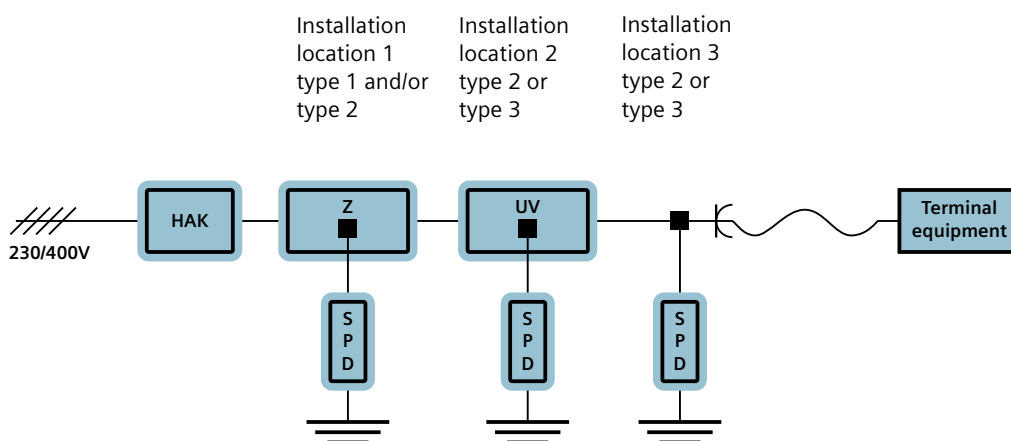

HAK: Main terminal box

Z/HV: In or close to the central meter system / main distribution board

UV: Subdistribution board

Installation location 1 must be as close as possible to the supply point for the electrical system, so that the downstream installations are protected. The SPDs at installation locations 2 and 3 shall not be used without SPDs at installation location 1, and they must be coordinated with these SPDs (i.e. SPDs all from the same manufacturer).

One point contact for your service needs

The comprehensive range of services from Siemens is sure to cover the needs of the most varied users. We offer structured

services, designed to give you valuable support in every phase during the lifecycle of your Final Distribution Products.

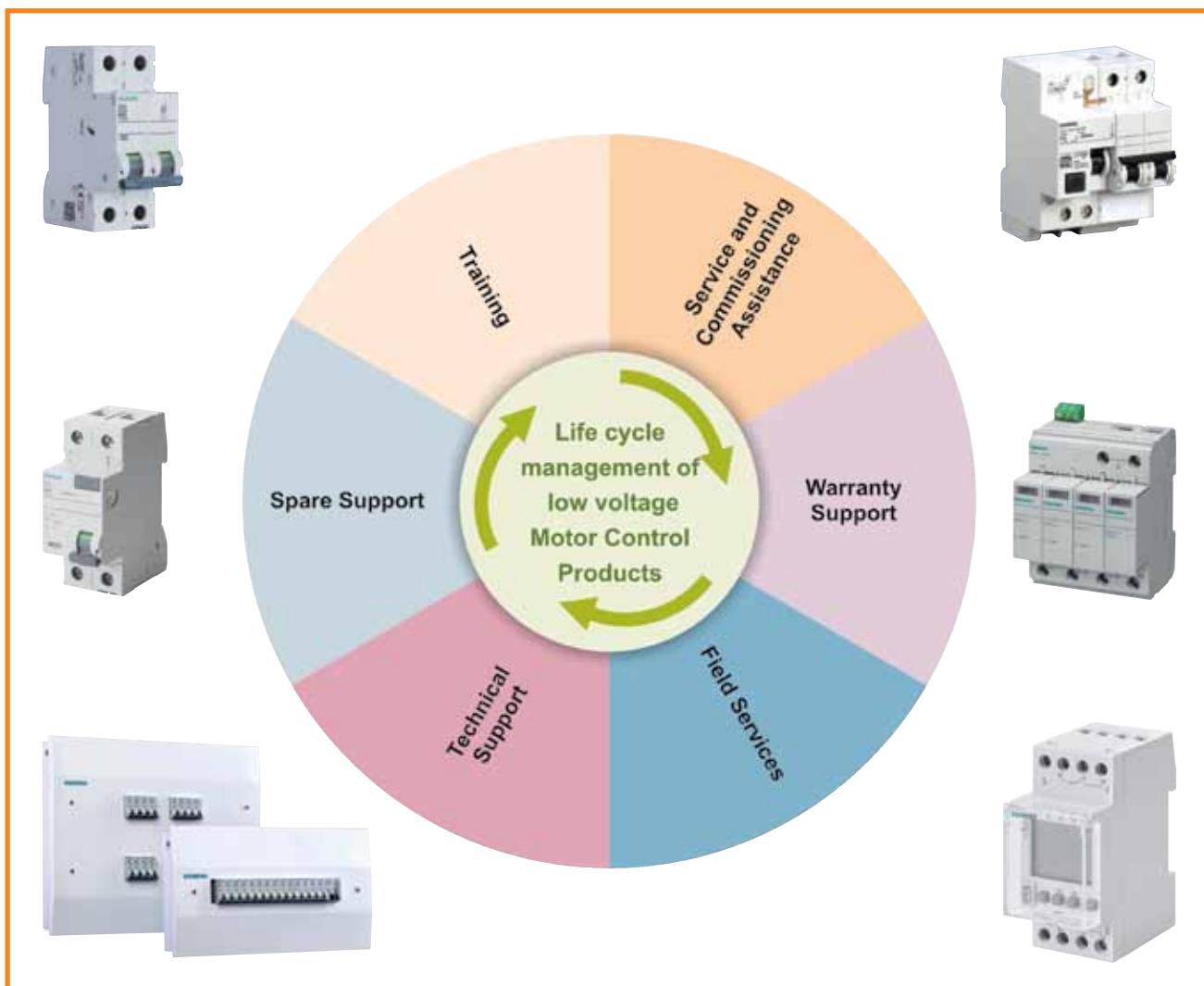

Please get in touch with us for details

CUSTOMER CARE

Toll Free No: 1800220987 / 18002090987 • E-mail: ics.india@siemens.com

Customer care

One stop support for all service needs:

- Breakdown service
- Annual maintenance contracts
- Retrofit solutions
- Spares

For more details please contact:

Customer care desk

Siemens Limited

R&D Technology Centre

Kalwa Works, Thane Belapur Road, Thane - 400 601

Toll free No.: 1800 209 0987 (MTNL/BSNL/Major Mobile operator lines), 1800 220 987 (BSNL/MTNL)

Tel.: 022-27600150 • Fax: 022-33265381

<http://support.automation.siemens.com/in>

