

Your trusted partner for reliable power

Low Voltage Power Distribution products
Price List w.e.f. 1st November, 2021

SIEMENS

LIST OF SITRAIN - INDIA TRAINING CENTERS

(including Training Service Providers, TSPs)

Course No.	Title	Duration
Classroom Courses - Automation		
AS-1200	SIMATIC S7-1200 with STEP7 V15.1	5
AS-1500A	SIMATIC S7-1500 with TIA V15 Advance	3
AS-1500B	SIMATIC S7-1500 with TIA V15 Basic	5
AS-300400A	SIMATIC S7-300/400 Advance with STEP7	6
AS-300A	SIMATIC S7-300 with STEP7 V5.6 Advance	3
AS-300B	SIMATIC S7-300 with STEP7 V5.6 Basic	5
AS-400A	SIMATIC S7-400 with STEP7 V5.6 Advance	3
AS-400B	SIMATIC S7-400 with STEP7 V5.6 Basic	5
AS-F&B_2	Training on WinCC Comfort-Advance V15.1_F&B 2 Days	2
AS-F&B_3	Training on SCADA with WinCC V7.5_F&B 3 Days	3
AS-NTW	Networking on Profibus/Profinet with V5.6	5
AS-PCS7A	DCS: SIMATIC PCS 7 Advance	10
AS-PCS7AS	DCS: SIMATIC PCS7 AS ENGINEERING	5
AS-PCS7B	DCS: SIMATIC PCS 7 Basic	10
AS-PCS7OS	DCS: SIMATIC PCS7 OS ENGINEERING	5
AS-PHARMA2	Training on WinCC Comfort-Advanced on TIA V15.1_Pharma 2 Days	2
AS-PHARMA3	Training on SCADA with WinCC V7.5_Pharma 3 Days	3
AS-PI	Process Instrumentation	4
AS-SFM	SIMATIC Distributed (Machine Safety) course	3
AS-SFP	SIMATIC Fail-safe (Process Safety) course	3
AS-ST57GRA	SIMATIC S7 Graph	2
AS-ST5CL	SCL Programming	3
AS-ST5TL	STL Programming Language	3
AS-TNTW	Networking on Profibus/Profinet with TIA Portal V15.1	3
AS-TWINCCB	SIMATIC WinCC (TIA Portal) Professional V15.1	5
AS-VASS	VASS Training	12
AS-WINCCA	SIMATIC WinCC V7.x Advance	3
AS-WINCCB	SIMATIC WinCC V7.x Basic	5

Course No.	Title	Duration
AS-PHARMA3	Training on SCADA with WinCC V7.5_Pharma	3
AS-PHARMA2	Training on WinCC Comfort-Advanced on TIA V15.1_Pharma 2	2
AS-F&B_2	Training on WinCC Comfort-Advance V15.1_F&B	2
AS-F&B_3	Training on SCADA with WinCC V7.5_F&B 3 Days	3
Classroom Courses - Drives		
DR-BDT	Basic course on AC/DC Drives	5
DR-DC70	SIMOREG DC Master 6RA70	6
DR-DCM	SINAMICS DC Master 6RA80	6
DR-G120	SINAMICS G120 with STARTER	5
DR-G12TIA	SINAMICS G120 With TIA Portal	4
DR-G130	SINAMICS G130 / G150	6
DR-GH180	SINAMICS Perfect Harmony GH180	5
DR-MDVC	AC Drive: SIMOVERT Master Drive Vector Control	6
DR-MM4	AC Drives with MM4 Maintenance	5
DR-OLS120B	Online Training - SINAMICS S120 Basic	5
DR-S120ADV	SINAMICS S120 Advance	5
DR-S120BAS	SINAMICS S120 Basic	5
DR-S12SAF	SINAMICS S120 Safety Functions	3
DR-SIMOADV	SIMOTION Advance	5
DR-SIMOBAS	SIMOTION Basic	5
DR-V20	SINAMICS V20	3
DR-V90	SINAMICS V90	3
AP-CRANE	Application Based Crane Training	5
Classroom Courses - Switchgear		
LV-BAS	Communication in Switchgear	3
LV-IM	AC Motor Basics Control & Maintenance	3
LV-PAC	Sentron PAC Meter	2
LV-SM	SIMOCODE AC-Motor control	3
LV-SS	SIRIUS Soft Starter	2
LV-SWPC	LV Switchgear Products & Coordination	4
LV-SWPD	LV Switchgear Products, Distribution & Panel	4
MV-NR	Training on Numerical relays	4

Course No.	Title	Duration
MV-VCB	Training on VCB	2
Online Trainings		
AS-OL-1200	SIMATIC S7-1200 with TIA Portal Course	5
AS-OL-300A	SIMATIC S7-300 with STEP7 V5.6 Advance	2
AS-OL-300B	SIMATIC S7-300 with SIMATIC Manager (Basic Course)	5
AS-OL-400A	SIMATIC S7-400 with SIMATIC Manager (Advance Course)	3
AS-OL-400B	SIMATIC S7-400 with SIMATIC Manager (Basic Course)	5
AS-OL-PCSB	DCS: SIMATIC PCS 7 Basic	9
AS-OL-PCSA	DCS: SIMATIC PCS7 AS ENGINEERING	5
AS-OL-SFM	SIMATIC Distributed (Machine Safety) course	3
AS-OL-WINC	Basic course for SIMATIC WinCC SCADA (V7)	5
AS-OL-WINT	SIMATIC WinCC SCADA (WinCC Prof) in the TIA Portal	5
AS-OL1500A	SIMATIC S7-1500 with TIA Portal (Advance Course)	5
AS-OL1500B	SIMATIC S7-1500 with TIA Portal (Basic Course)	5
ACCESS-P	SITRAIN access single Subscription	365
DR-DCM	SINAMICS DC Master 6RA80	6
DR-SIMOBAS	SIMOTION Basic	5
DR-S120BAS	SINAMICS S120 Basic	5
DR-S120ADV	SINAMICS S120 Advance	5
LV-SM	SIMOCODE AC-Motor Control	3
DR-G120TIA	SINAMICS G120	4
LV-SWPC	LV Switchgear Products & Coordination	4
Digitalization Training		
DIGI-AUTOE	Digitalization Auto Engineering	5
DIGI-IN4.0	Introduction to Industry 4.0	3
DIGI-STDISI	Digitalization Stand_SiVArc	3
DIGI_INTRO	One Day Training Program on Introduction to Digitalization	1

SITRAIN Training Executors in India (Address & Contacts)

SITRAIN India (Kalwa)
 Siemens Ltd.
 TSDC, Kalwa Works
 Opposite Airoli Railway Station
 Thane Belapur Road, Airoli
 Navi Mumbai - 400708, Maharashtra
 Tel: +91-22-39663208
 E-mail: customer.training.in@siemens.com

STE-NORTH 1 (Panchkula)
 Industrial Automation Training Centre
 178, Phase II, Industrial Area
 Panchakula -134113, Haryana, India.
 Tel: +91-172-5044417
 E-mail: info@iatc.in

STE-East (Kolkata)
 Unit No-207A, 2nd Floor, PS Aviator
 Atghara, Rajarhat Newtown, Chinarpark
 Kolkata - 700136
 Tel: +91-8820378858
 E-mail: koltc@esskay.in

STE - SOUTH 1 (Coimbatore)
 Karunya – SIEMENS Centre
 Karunya University, Karunya Nagar
 Coimbatore - 641114
 Tel: +91-422-2614400/4399
 E-mail: siemens@karunya.edu

STE-WEST 1 (Navi-Mumbai)
 Esskay Services
 Block No. 801-802, B Wing, Techno City
 Plot No. X-41 & X-42, TTC Industrial Area
 Mahape, Navi Mumbai - 460710
 Tel: +91-22-27788403
 E-mail: mumtc@esskay.in



Index

Contents	Page No.
1 Air Circuit Breakers	4-7, 33-36
Air circuit breakers - SENTRON 3WA NEW	4-7
Air circuit breakers - SENTRON 3WT ^{Plus}	34
Accessories for SENTRON 3WT ^{Plus} ACBs	35
Air circuit breakers - SENTRON 3WL ^{Plus}	36
Accessories for SENTRON 3WL ^{Plus} ACBs	36
2 Moulded Case Circuit Breakers	8-32
Moulded case circuit breakers - SENTRON 3VA	10
Accessories for 3VA	16
Moulded case circuit breaker - SENTRON 3VA27	17
Moulded case circuit breakers - SENTRON 3VM	19
Accessories for 3VM	24
Moulded case circuit breakers - 3VT2...3	25
Accessories for 3VT2...3	25
Moulded case circuit breakers - 3VT4...5	26
Accessories for 3VT4...5	26
Moulded case circuit breakers - SINOVA 3VJ NEW	28
Accessories for 3VJ NEW	32
3 SIMARIS software tools	37
4 Automatic transfer controller - SENTRON ATC 3100/6300/6500	38-39
5 SIVACON S8	40
6 Energy Management System	41-44
Multifunction meter SMART 7KT	42
Multifunction meter SENTRON 7KM PAC 3120 / 3220 / 4200	42
Energy Management Software: SENTRON powermanager	42
Power Quality Measurement SENTRON 7KM PAC 5100 / 5200	43
DIN rail mounted meters SENTRON 7KM PAC 2200/ 3200T / 7KT PAC1600	44
7 Load Break Switches	45-53
Fuse switch disconnecter - 3NP1	46
Switch disconnecter fuse - 3KL8 (4P/3PN/3P)	49
Switch disconnecter fuse - 3KL8 (2P)	50
Switch disconnecter fuse in SS housing - 3KL8 (3PN/4P) NEW	50
Switch disconnecter - 3KA8 (2P/3PN/4P)	51
Accessories for 3KL8/ 3KA8 (2P/3P/3PN/4P) NEW	51
Main control & emergency stop switches - 3LD2	52
Accessories for 3LD2	53
Rotary switches - 3LA0	53
8 Control switches - 3LD4	54-60
Instrumentation Selector Switch	55
ON OFF Switches NEW	55
Changeover Switch NEW	56
Phase Changeover Switch (PCS) NEW	56
Multistep Switch NEW	57

Contents	Page No.
9 INDUSTRY 4.0	61
10 Arc Fault Detection Device	62
11 Betagard Circuit Protection Devices	63-64
Betagard Miniature Circuit Breakers - 5SL6/5SL4	63
Betagard Circuit Breakers - 5SL7/5SL5	64
12 Fuses	65-71
DIN fuses - 3NA / Fuse bases (DIN)	66
DIN isolating links - 3NG	66
BS fuses - 3NW	67
Fuse holders and accessories for fuses - 3NW	67
Fuses for semiconductor protection - 3NE/ 3NC	68
Cylindrical fuses - 3NW	70
SENTRON 3NA COM LV HRC fuse link NEW	71
13 Power Quality Solutions -PQS	72-76
LV Power Capacitors - SIECAP 4RB	73
Harmonics filter detuned reactor	75
Capacitor duty contactors - 3TS / 3MT	76
Automatic power factor correction relay - APFCR	76
14 Numerical Relays and Auxiliary Relays	77-79
15 Type-2 Co-ordination Charts	80-83
16 SENTRON Digitalization solutions NEW	84-85
17 SENTRON 7KN Powercenter 3000 NEW	86
18 5SD Surge Protection Device	93
19 Available till stocks last	87
20 Discontinued products	88
21 Contact Partners	
Customer care	92
Training centres	Front cover inside
Terms and conditions	94
Offices and territory managers	Back cover





| 3WA air circuit breakers

Made for makers. Simply reliable

Fail-safe power distribution is a job for makers. The 3WA air circuit breaker makes sure you get the job done reliably.

3WA air circuit breakers continue Siemens' tradition of switchgear innovation and bring power distribution into the digital age. Whether you are quality-conscious, efficient, future-, or system-oriented: The 3WA air circuit breaker will be the new central component in your panel.

[siemens.com/3wa](https://www.siemens.com/3wa)



Scan for
more info



Future
ready



Easy
operation



Advanced
connectivity

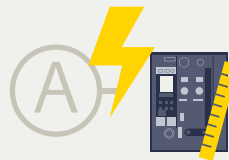

Smallest
footprint



Shorter
downtime



Efficient
metering



Easy
upgrade



Enhanced
safety



Cyber
security



High system
availability



3WA air circuit breakers

The future of digital power distribution

The future will be connected.

The makers of tomorrow will require advanced diagnostics and safety during operation. They will need access to their power distribution system remotely and securely. With 3WA we invite you to a more connected and sustainable tomorrow.

Welcome to the future of digital power distribution.

[siemens.com/3wa](https://www.siemens.com/3wa)

SIEMENS

The most comprehensive range for all Low Voltage applications

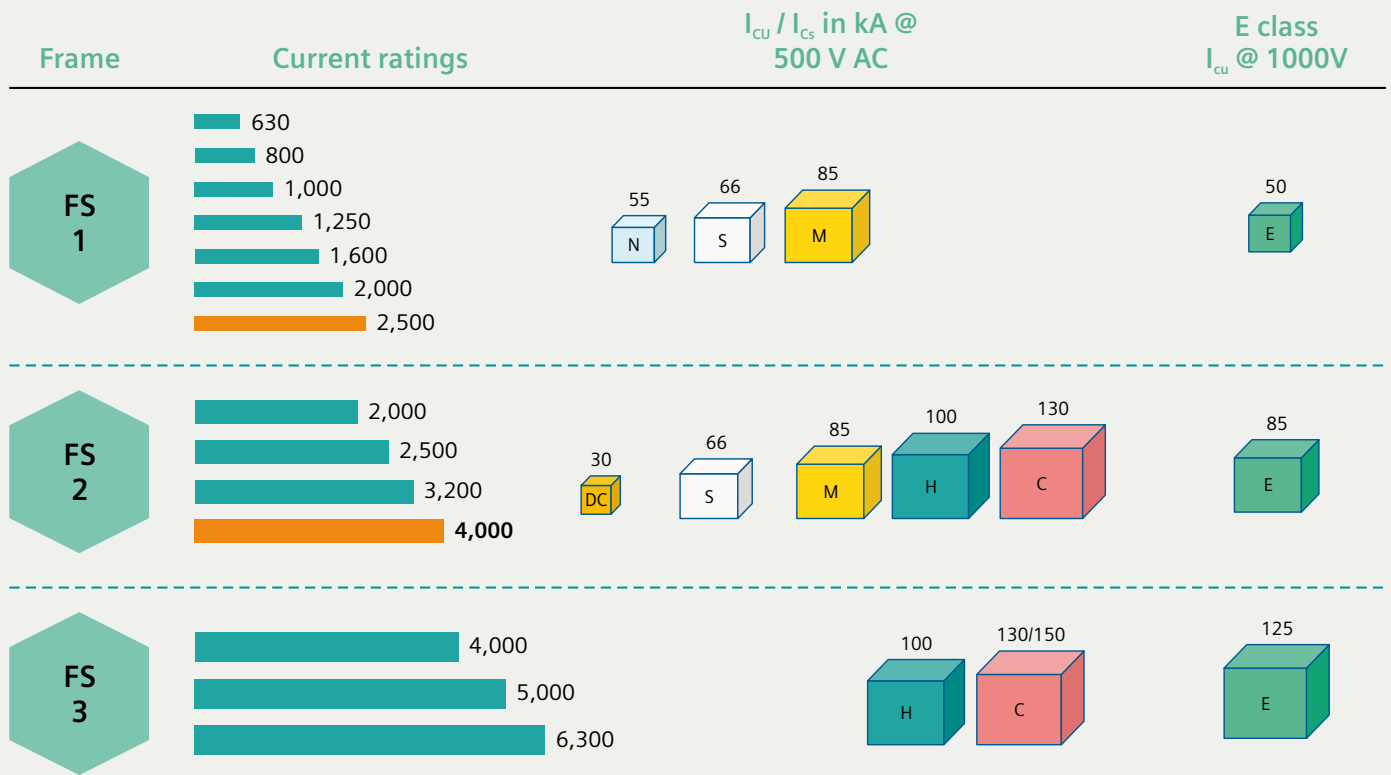

$I_{cu} = I_{cs} = I_{cw(1s)}$

Smallest footprint | Highest performance

E class for special applications



USB-C



Bluetooth

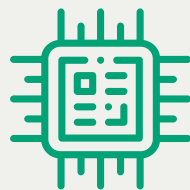

Two processor design



Online upgrade



Easy diagnostics

Available from December 2021

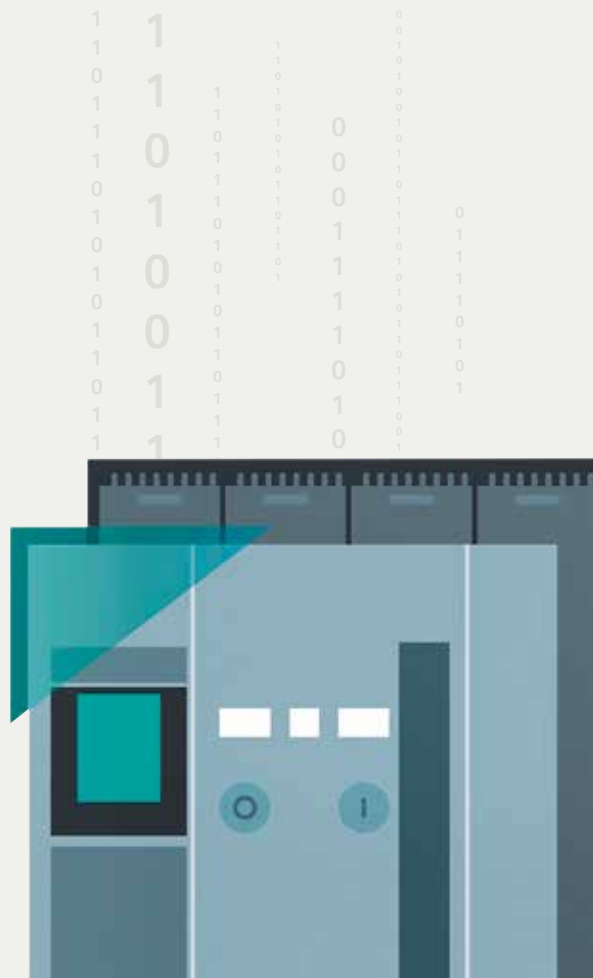



One system. Worldwide application.

The 3VA moulded case circuit breaker with UL certification

We have good news for machine and switchgear manufacturers who export worldwide: The 3VA5 and 3VA6 series of our 3VA moulded case circuit breakers with UL certification comply with the UL 489 standard as well as the IEC 60947 standard. All the functionalities of this modular and highly variable moulded case circuit breaker system can be used in plants that are operated, for example, in North America or Europe. The 3VA moulded case circuit breaker: One system. Worldwide application.

For more information, call us on 1800 209 1800 or visit us at www.siemens.com/3VA

For life cycle support for products, systems and solutions, call us at 1800 209 0987 or email us at ics.india@siemens.com

www.siemens.com/3VA

SIEMENS



3VA moulded case circuit breakers

Discover the perfect system

www.siemens.com/3VA

SIEMENS

MCCB: SENTRON 3VA

- Rated current: 16A to 1250A
- 1 pole[^], 2 pole[^], 3 pole & 4 pole versions
- Thermal magnetic and Microprocessor based trip unit
- Common Internal accessories for the entire range
- Information on the GO - Unique Knowledge Manager (QR Code) for 24 X 7 Technical Information
- Innovative Accessories viz. Short Circuit Alarm Switch, Illuminated Handle, Shunt Trip Flexible etc



SENTRON 3VA MCCB, Thermal Magnetic Trip Unit, Fixed Thermal Fixed Magnetic (FTFM), Ics = 100% Icu, 415VAC, 50Hz

Frame Size	Breaking Capacity @ 415VAC, 50Hz	Rated Current In (A)	3 Pole		4 Pole	
			Type	Unit LP* ₹	Type	Unit LP* ₹
3VA10	16kA	16	3VA1096-2ED32-0AA0	8865.-	3VA1096-2ED42-0AA0	11495.-
		20	3VA1020-2ED32-0AA0	8865.-	3VA1020-2ED42-0AA0	11495.-
		25	3VA1025-2ED32-0AA0	8865.-	3VA1025-2ED42-0AA0	11495.-
		32	3VA1032-2ED32-0AA0	8865.-	3VA1032-2ED42-0AA0	11495.-
		40	3VA1040-2ED32-0AA0	8865.-	3VA1040-2ED42-0AA0	11495.-
		50	3VA1050-2ED32-0AA0	8865.-	3VA1050-2ED42-0AA0	11495.-
		63	3VA1063-2ED32-0AA0	8865.-	3VA1063-2ED42-0AA0	11495.-
		80	3VA1080-2ED32-0AA0	9700.-	3VA1080-2ED42-0AA0	12595.-
3VA10	25kA	100	3VA1010-2ED32-0AA0	11225.-	3VA1010-2ED42-0AA0	14620.-
		16	3VA1096-3ED32-0AA0	9105.-	3VA1096-3ED42-0AA0	11880.-
		20	3VA1020-3ED32-0AA0	9105.-	3VA1020-3ED42-0AA0	11880.-
		25	3VA1025-3ED32-0AA0	9105.-	3VA1025-3ED42-0AA0	11880.-
		32	3VA1032-3ED32-0AA0	9105.-	3VA1032-3ED42-0AA0	11880.-
		40	3VA1040-3ED32-0AA0	9105.-	3VA1040-3ED42-0AA0	11880.-
		50	3VA1050-3ED32-0AA0	9105.-	3VA1050-3ED42-0AA0	11880.-
		63	3VA1063-3ED32-0AA0	9105.-	3VA1063-3ED42-0AA0	11880.-
3VA11	25kA	80	3VA1080-3ED32-0AA0	9905.-	3VA1080-3ED42-0AA0	12890.-
		100	3VA1010-3ED32-0AA0	11675.-	3VA1010-3ED42-0AA0	14920.-
3VA11	25kA	125	3VA1112-3ED32-0AA0	19685.-	3VA1112-3ED42-0AA0	25085.-
		160	3VA1116-3ED32-0AA0	22475.-	3VA1116-3ED42-0AA0	29250.-
3VA10	36kA	16	3VA1096-4ED32-0AA0	9610.-	3VA1196-4GD42-0AA0	13300.-
		20	3VA1020-4ED32-0AA0	9610.-	3VA1120-4GD42-0AA0	13300.-
		25	3VA1025-4ED32-0AA0	9610.-	3VA1125-4GD42-0AA0	13300.-
		32	3VA1032-4ED32-0AA0	9610.-	3VA1132-4GD42-0AA0	13300.-
		40	3VA1040-4ED32-0AA0	9610.-	3VA1140-4GD42-0AA0	13300.-
		50	3VA1050-4ED32-0AA0	9610.-	3VA1150-4GD42-0AA0	13300.-
		63	3VA1063-4ED32-0AA0	9610.-	3VA1163-4GD42-0AA0	13300.-
		80	3VA1080-4ED32-0AA0	10085.-	3VA1180-4GD42-0AA0	14585.-
3VA11	36kA	100	3VA1010-4ED32-0AA0	12145.-	3VA1110-4GD42-0AA0	16845.-
		125	3VA1112-4ED32-0AA0	20975.-	3VA1112-4GD42-0AA0	27270.-
3VA11	36kA	160	3VA1116-4ED32-0AA0	24460.-	3VA1116-4GD42-0AA0	31800.-
		16	3VA1196-5ED32-0AA0	11265.-	3VA1196-5GD42-0AA0	14620.-
3VA11	55kA	20	3VA1120-5ED32-0AA0	11265.-	3VA1120-5GD42-0AA0	14620.-
		25	3VA1125-5ED32-0AA0	11265.-	3VA1125-5GD42-0AA0	14620.-
		32	3VA1132-5ED32-0AA0	11265.-	3VA1132-5GD42-0AA0	14620.-
		40	3VA1140-5ED32-0AA0	11265.-	3VA1140-5GD42-0AA0	14620.-
		50	3VA1150-5ED32-0AA0	11265.-	3VA1150-5GD42-0AA0	14620.-
		63	3VA1163-5ED32-0AA0	11480.-	3VA1163-5GD42-0AA0	14620.-
		80	3VA1180-5ED32-0AA0	12355.-	3VA1180-5GD42-0AA0	16055.-
		100	3VA1110-5ED32-0AA0	14305.-	3VA1110-5GD42-0AA0	18555.-
		125	3VA1112-5ED32-0AA0	23050.-	3VA1112-5GD42-0AA0	29960.-
		160	3VA1116-5ED32-0AA0	26880.-	3VA1116-5GD42-0AA0	34975.-

[^] 3VA1 TMTU up to 160A

Std. Pkg. = 1 unit * LP - List Price

SENTRON 3VA MCCB, Thermal Magnetic Trip Unit, Adj. Thermal Fixed Magnetic (ATFM), Ics = 100% Icu, 415VAC, 50Hz

Frame Size	Breaking Capacity @ 415VAC, 50Hz	Rated Current In (A)	3 Pole		4 Pole	
			Type	Unit LP* ₹	Type	Unit LP* ₹
3VA11	25kA	16	3VA1196-3EE32-0AA0	11560.-	3VA1196-3GE42-0AA0	16555.-
		20	3VA1120-3EE32-0AA0	11560.-	3VA1120-3GE42-0AA0	16555.-
		25	3VA1125-3EE32-0AA0	11560.-	3VA1125-3GE42-0AA0	16555.-
		32	3VA1132-3EE32-0AA0	11560.-	3VA1132-3GE42-0AA0	16555.-
		40	3VA1140-3EE32-0AA0	11560.-	3VA1140-3GE42-0AA0	16555.-
		50	3VA1150-3EE32-0AA0	11560.-	3VA1150-3GE42-0AA0	16555.-
		63	3VA1163-3EE32-0AA0	11560.-	3VA1163-3GE42-0AA0	16555.-
		80	3VA1180-3EE32-0AA0	11560.-	3VA1180-3GE42-0AA0	16555.-
		100	3VA1110-3EE32-0AA0	12355.-	3VA1110-3GE42-0AA0	16555.-
		125	3VA1112-3EE32-0AA0	20975.-	3VA1112-3GE42-0AA0	25830.-
3VA11	36kA	16	3VA1196-4EE32-0AA0	14275.-	3VA1196-4GE42-0AA0	18680.-
		20	3VA1120-4EE32-0AA0	14275.-	3VA1120-4GE42-0AA0	18680.-
		25	3VA1125-4EE32-0AA0	14275.-	3VA1125-4GE42-0AA0	18680.-
		32	3VA1132-4EE32-0AA0	14275.-	3VA1132-4GE42-0AA0	18680.-
		40	3VA1140-4EE32-0AA0	14275.-	3VA1140-4GE42-0AA0	18680.-
		50	3VA1150-4EE32-0AA0	14275.-	3VA1150-4GE42-0AA0	18680.-
		63	3VA1163-4EE32-0AA0	14275.-	3VA1163-4GE42-0AA0	18680.-
		80	3VA1180-4EE32-0AA0	14275.-	3VA1180-4GE42-0AA0	18680.-
		100	3VA1110-4EE32-0AA0	14275.-	3VA1110-4GE42-0AA0	18680.-
		125	3VA1112-4EE32-0AA0	21965.-	3VA1112-4GE42-0AA0	27980.-
3VA12		160	3VA1116-4EE32-0AA0	25135.-	3VA1116-4GE42-0AA0	32620.-
		200	3VA1220-4EE32-0AA0	31710.-	3VA1220-4GE42-0AA0	39070.-
3VA13		250	3VA1225-4EE32-0AA0	33615.-	3VA1225-4GE42-0AA0	42205.-
		320	3VA1332-4EE32-0AA0	45075.-	3VA1332-4GE42-0AA0	58355.-
3VA14		400	3VA1340-4EE32-0AA0	45075.-	3VA1340-4GE42-0AA0	58355.-
		500	3VA1450-4EE32-0AA0	58175.-	3VA1450-4GE42-0AA0	75365.-
3VA11	55kA	630	3VA1463-4EE32-0AA0	58175.-	3VA1463-4GE42-0AA0	75365.-
		16	3VA1196-5EE32-0AA0	16265.-	3VA1196-5GE42-0AA0	20555.-
		20	3VA1120-5EE32-0AA0	16265.-	3VA1120-5GE42-0AA0	20555.-
		25	3VA1125-5EE32-0AA0	16265.-	3VA1125-5GE42-0AA0	20555.-
		32	3VA1132-5EE32-0AA0	16265.-	3VA1132-5GE42-0AA0	20555.-
		40	3VA1140-5EE32-0AA0	16265.-	3VA1140-5GE42-0AA0	20555.-
		50	3VA1150-5EE32-0AA0	16265.-	3VA1150-5GE42-0AA0	20555.-
		63	3VA1163-5EE32-0AA0	16265.-	3VA1163-5GE42-0AA0	20555.-
		80	3VA1180-5EE32-0AA0	16265.-	3VA1180-5GE42-0AA0	20555.-
		100	3VA1110-5EE32-0AA0	16265.-	3VA1110-5GE42-0AA0	20555.-
3VA12		125	3VA1112-5EE32-0AA0	25540.-	3VA1112-5GE42-0AA0	30675.-
		160	3VA1116-5EE32-0AA0	27630.-	3VA1116-5GE42-0AA0	35660.-
3VA13		200	3VA1220-5EE32-0AA0	33020.-	3VA1220-5GE42-0AA0	40330.-
		250	3VA1225-5EE32-0AA0	35010.-	3VA1225-5GE42-0AA0	44350.-
3VA14		320	3VA1332-5EE32-0AA0	51400.-	3VA1332-5GE42-0AA0	64390.-
		400	3VA1340-5EE32-0AA0	51400.-	3VA1340-5GE42-0AA0	64390.-
3VA15		500	3VA1450-5EE32-0AA0	66475.-	3VA1450-5GE42-0AA0	83045.-
		630	3VA1463-5EE32-0AA0	66475.-	3VA1463-5GE42-0AA0	83045.-
3VA15		800#	3VA1580-5EF32-0AA0	99320.-	3VA1580-5GF42-0AA0	128710.-
		1000#	3VA1510-5EF32-0AA0	138750.-	3VA1510-5GF42-0AA0	180045.-
3VA11	70kA	16	3VA1196-6EE32-0AA0	22250.-	3VA1196-6GE42-0AA0	27970.-
		20	3VA1120-6EE32-0AA0	22250.-	3VA1120-6GE42-0AA0	27970.-
		25	3VA1125-6EE32-0AA0	22250.-	3VA1125-6GE42-0AA0	27970.-
		32	3VA1132-6EE32-0AA0	22250.-	3VA1132-6GE42-0AA0	27970.-
		40	3VA1140-6EE32-0AA0	22250.-	3VA1140-6GE42-0AA0	27970.-
		50	3VA1150-6EE32-0AA0	22250.-	3VA1150-6GE42-0AA0	27970.-
		63	3VA1163-6EE32-0AA0	22250.-	3VA1163-6GE42-0AA0	27970.-
		80	3VA1180-6EE32-0AA0	22250.-	3VA1180-6GE42-0AA0	27970.-
		100	3VA1110-6EE32-0AA0	22250.-	3VA1110-6GE42-0AA0	27970.-
		125	3VA1112-6EE32-0AA0	41370.-	3VA1112-6GE42-0AA0	44365.-
3VA12		160	3VA1116-6EE32-0AA0	41370.-	3VA1116-6GE42-0AA0	44365.-
		200	3VA1220-6EE32-0AA0	44530.-	3VA1220-6GE42-0AA0	57295.-
3VA13		250	3VA1225-6EE32-0AA0	49905.-	3VA1225-6GE42-0AA0	57295.-
		320	3VA1332-6EE32-0AA0	56340.-	3VA1332-6GE42-0AA0	72835.-
3VA14		400	3VA1340-6EE32-0AA0	56340.-	3VA1340-6GE42-0AA0	72835.-
		500	3VA1450-6EE32-0AA0	80085.-	3VA1450-6GE42-0AA0	103830.-
3VA15		630	3VA1463-6EE32-0AA0	80085.-	3VA1463-6GE42-0AA0	103830.-
		800#	3VA1580-6EF32-0AA0	109370.-	3VA1580-6GF42-0AA0	141730.-
		1000#	3VA1510-6EF32-0AA0	152515.-	3VA1510-6GF42-0AA0	198265.-

Std. Pkg. = 1 unit

- Adjustable Thermal, Adjustable Magnetic

* LP - List Price

SENTRON 3VA - Flying on the wings of technology

SENTRON 3VA MCCB, Thermal Magnetic Trip Unit, Adj. Thermal Adj. Magnetic (ATAM), Ics = 100% Icu, 415VAC, 50Hz

Frame Size	Breaking Capacity @ 415VAC, 50Hz	Rated Current In (A)	3 Pole		4 Pole	
			Type	Unit LP* ₹	Type	Unit LP* ₹
3VA12	36kA	250	3VA1225-4EF32-0AA0	Price on Request	3VA1225-4GF42-0AA0	Price on Request
3VA13		320	3VA1332-4EF32-0AA0		3VA1332-4GF42-0AA0	
		400	3VA1340-4EF32-0AA0		3VA1340-4GF42-0AA0	
3VA14		500	3VA1450-4EF32-0AA0		3VA1450-4GF42-0AA0	
		630	3VA1463-4EF32-0AA0		3VA1463-4GF42-0AA0	
3VA12	55kA	250	3VA1225-5EF32-0AA0		3VA1225-5GF42-0AA0	
3VA13		320	3VA1332-5EF32-0AA0		3VA1332-5GF42-0AA0	
		400	3VA1340-5EF32-0AA0		3VA1340-5GF42-0AA0	
3VA14		500	3VA1450-5EF32-0AA0		3VA1450-5GF42-0AA0	
		630	3VA1463-5EF32-0AA0		3VA1463-5GF42-0AA0	
3VA12	70kA	250	3VA1225-6EF32-0AA0		3VA1225-6GF42-0AA0	
3VA13		320	3VA1332-6EF32-0AA0		3VA1332-6GF42-0AA0	
		400	3VA1340-6EF32-0AA0		3VA1340-6GF42-0AA0	
3VA14		500	3VA1450-6EF32-0AA0		3VA1450-6GF42-0AA0	
		630	3VA1463-6EF32-0AA0		3VA1463-6GF42-0AA0	

For lower ratings, kindly contact nearest Sales office

SENTRON 3VA MCCB for Motor Starter Protection (Adjustable Magnetic trip unit, 3pole)

Frame Size	Rated Current In (A)	Breaking Capacity (55kA, 415V, 50Hz)		Breaking Capacity (70kA, 415V, 50Hz)	
		Type	Unit LP* ₹	Type	Unit LP* ₹
3VA11	1	3VA1181-5MG32-0AA0*	14955.-	3VA1181-6MG32-0AA0*	18365.-
	2	3VA1102-5MG32-0AA0*	14955.-	3VA1102-6MG32-0AA0*	18365.-
	4	3VA1104-5MG32-0AA0*	14955.-	3VA1104-6MG32-0AA0*	18365.-
	8	3VA1108-5MG32-0AA0*	14955.-	3VA1108-6MG32-0AA0*	18365.-
	12.5	3VA1192-5MG32-0AA0*	14955.-	3VA1192-6MG32-0AA0*	18365.-
	20	3VA1120-5MH32-0AA0	14955.-	3VA1120-6MH32-0AA0	18365.-
	32	3VA1132-5MH32-0AA0	17865.-	3VA1132-6MH32-0AA0	19250.-
	40	3VA1140-5MH32-0AA0	17865.-	3VA1140-6MH32-0AA0	19250.-
	50	3VA1150-5MH32-0AA0	17865.-	3VA1150-6MH32-0AA0	19250.-
	63	3VA1163-5MH32-0AA0	17865.-	3VA1163-6MH32-0AA0	19250.-
	80	3VA1180-5MH32-0AA0	17865.-	3VA1180-6MH32-0AA0	19250.-
	100	3VA1110-5MH32-0AA0	17865.-	3VA1110-6MH32-0AA0	19250.-
	125	3VA1112-5MH32-0AA0	25625.-	3VA1112-6MH32-0AA0	27700.-
3VA12	160	3VA1216-5MH32-0AA0	26890.-	3VA1216-6MH32-0AA0	38320.-
	200	3VA1220-5MH32-0AA0	36980.-	3VA1220-6MH32-0AA0	45385.-
3VA13	250	3VA1325-5MH32-0AA0	40350.-	3VA1325-6MH32-0AA0	45930.-
	320	3VA1332-5MH32-0AA0	55375.-	3VA1332-6MH32-0AA0	63100.-
3VA14	400	3VA1440-5MH32-0AA0	63390.-	3VA1440-6MH32-0AA0	66225.-
	500	3VA1450-5MH32-0AA0	72970.-	3VA1450-6MH32-0AA0	82845.-
3VA15	630	3VA1563-5MH32-0AA0	84125.-	3VA1563-6MH32-0AA0	91645.-
	800	3VA1580-5MH32-0AA0	111740.-	3VA1580-6MH32-0AA0	123040.-

Std. Pkg. = 1 unit

* LP - List Price

& Fixed magnetic trip unit

SENTRON 3VA MCCB, Switch Disconnector (without protection)

Frame Size	Breaking Capacity	Rated Current In (A)	3 Pole		4 Pole	
			Type	Unit LP* ₹	Type	Unit LP* ₹
3VA11	NA	63	3VA1163-1AA32-0AA0	12550.-	3VA1163-1AA42-0AA0	18545.-
		100	3VA1110-1AA32-0AA0	12550.-	3VA1110-1AA42-0AA0	18545.-
		125	3VA1112-1AA32-0AA0	25675.-	3VA1112-1AA42-0AA0	34230.-
		160	3VA1116-1AA32-0AA0	25675.-	3VA1116-1AA42-0AA0	34230.-
3VA12	NA	250	3VA1225-1AA32-0AA0	25675.-	3VA1225-1AA42-0AA0	34230.-
3VA13	NA	400	3VA1340-1AA32-0AA0	33120.-	3VA1340-1AA42-0AA0	43060.-

NA - Not Applicable

Earth fault and Earth leakage protection for SENTRON 3VA moulded case circuit breaker

Earth fault monitoring relay

Description	Type	Unit LP* ₹
Earth fault monitoring relay • Auxiliary voltage: 85-270V AC/DC • Change over contact: 2C/O • Width: 35mm module	7UG0861-1BU20	5120.-
CBCT for EFR: 160 frame Suitable for 3VA1 up to 160A	3P: 7UG09910 4P: 7UG09911	1765.- 2015.-
CBCT for EFR: 250 frame Suitable for 3VA1 250A, 3VA2 up to 250A	3P: 7UG09912 4P: 7UG09913	2135.- 2515.-
CBCT for EFR: 630 frame Suitable for 3VA2 400A/ 630A	3P: 7UG09914 4P: 7UG09915	3145.- 3400.-



Earth leakage monitoring relay

Description	Type	Unit LP* ₹
Earth leakage relay 1Ph-2W, 3Ph-3W, 3Ph-4W	110VAC: 7UG0841-1CB20 230VAC: 7UG0842-1CD20	4950.- 5000.-
CBCT for ELR	35 mm dia: 7UG0996 70 mm dia: 7UG0997 120 mm dia: 7UG0999 210 mm dia: 7UG0994 310 mm dia: 7UG0995	1790.- 2040.- 3440.- 6440.- 9595.-



Note: Order 1 no of shunt trip release for MCCB separately along with earth fault relay / earth leakage relay



Std. Pkg. = 1 unit

* LP - List Price

Condition monitoring with the 3VA moulded case circuit breaker. As simple as that.

www.siemens.co.in

Thanks to optimally scheduled maintenance times, you can prevent equipment and plant failures due to uncoordinated maintenance of individual devices and optimize the health of your entire plant.



Predictive maintenance



Improved organization of personnel and material costs



Optimized energy availability



Reduced time and costs for maintenance



When time savings go hand in hand with optimized plant reliability



With condition monitoring directly on the 3VA and remotely on the end device, you get reliable information about the health of your system and the remaining service life of your circuit breaker.

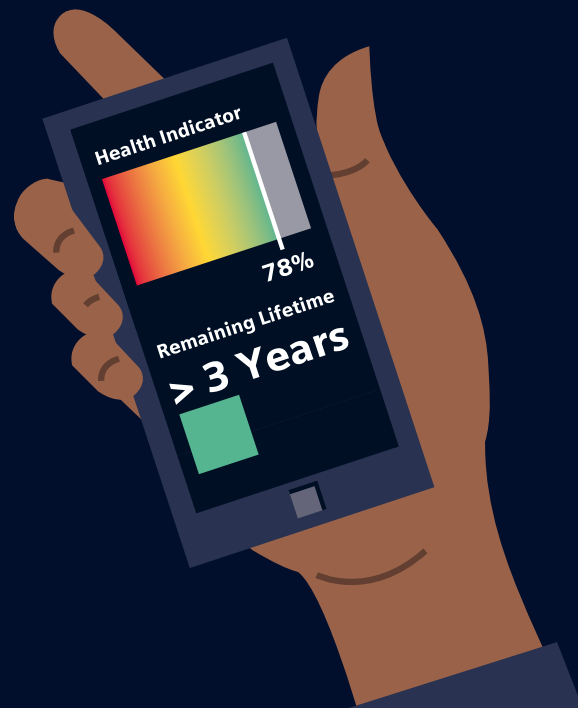

SENTRON 3VA MCCB, Microprocessor Trip Unit, ETU320 LI, Ics = 100% Icu, 415VAC, 50Hz

Frame Size	Breaking Capacity @ 415VAC, 50Hz	Rated Current In (A)	3 Pole		4 Pole	
			Type	Unit LP* ₹	Type	Unit LP* ₹
3VA20	36kA	25	3VA2025-4HL32-0AA0	26250.-	3VA2025-4HL42-0AA0	33840.-
		40	3VA2040-4HL32-0AA0	26250.-	3VA2040-4HL42-0AA0	33840.-
		63	3VA2063-4HL32-0AA0	26250.-	3VA2063-4HL42-0AA0	33840.-
		100	3VA2010-4HL32-0AA0	26250.-	3VA2010-4HL42-0AA0	33840.-
		160	3VA2116-4HL32-0AA0	35485.-	3VA2116-4HL42-0AA0	49525.-
		250	3VA2225-4HL32-0AA0	48700.-	3VA2225-4HL42-0AA0	66035.-
		400	3VA2340-4HL32-0AA0	65070.-	3VA2340-4HL42-0AA0	85645.-
3VA21	55kA	630	3VA2463-4HL32-0AA0	67650.-	3VA2463-4HL42-0AA0	89640.-
3VA22		25	3VA2025-5HL32-0AA0	33380.-	3VA2025-5HL42-0AA0	45725.-
3VA23		40	3VA2040-5HL32-0AA0	33380.-	3VA2040-5HL42-0AA0	45725.-
3VA24		63	3VA2063-5HL32-0AA0	33380.-	3VA2063-5HL42-0AA0	45725.-
3VA25		100	3VA2010-5HL32-0AA0	33380.-	3VA2010-5HL42-0AA0	45725.-
		160	3VA2116-5HL32-0AA0	42310.-	3VA2116-5HL42-0AA0	54790.-
		250	3VA2225-5HL32-0AA0	55280.-	3VA2225-5HL42-0AA0	72985.-
3VA26 NEW	400	3VA2340-5HL32-0AA0	70160.-	3VA2340-5HL42-0AA0	91945.-	
	630	3VA2463-5HL32-0AA0	86180.-	3VA2463-5HL42-0AA0	96245.-	
	800	3VA2580-5HL32-0AA0	126015.-	3VA2580-5HL42-0AA0	161200.-	
3VA20	85kA	1000	3VA2510-5HL32-0AA0	166975.-	3VA2510-5HL42-0AA0	222920.-
		1250	3VA2612-5HL32-0AA0	236735.-	3VA2612-5HL42-0AA0	316120.-
		25	3VA2025-6HL32-0AA0	43635.-	3VA2025-6HL42-0AA0	54065.-
		40	3VA2040-6HL32-0AA0	43635.-	3VA2040-6HL42-0AA0	54065.-
		63	3VA2063-6HL32-0AA0	43635.-	3VA2063-6HL42-0AA0	54065.-
		100	3VA2010-6HL32-0AA0	43635.-	3VA2010-6HL42-0AA0	54065.-
		160	3VA2116-6HL32-0AA0	57220.-	3VA2116-6HL42-0AA0	73045.-
		250	3VA2225-6HL32-0AA0	63545.-	3VA2225-6HL42-0AA0	92545.-
		400	3VA2340-6HL32-0AA0	79745.-	3VA2340-6HL42-0AA0	104715.-
		630	3VA2463-6HL32-0AA0	95265.-	3VA2463-6HL42-0AA0	127115.-
3VA25	800	3VA2580-6HL32-0AA0	138545.-	3VA2580-6HL42-0AA0	184290.-	
	1000	3VA2510-6HL32-0AA0	190955.-	3VA2510-6HL42-0AA0	254895.-	
3VA26 NEW	1250	3VA2612-6HL32-0AA0	270555.-	3VA2612-6HL42-0AA0	362150.-	

SENTRON 3VA MCCB, Microprocessor Trip Unit, ETU330 LIG, Ics = 100% Icu, 415VAC, 50Hz

Frame Size	Breaking Capacity @ 415VAC, 50Hz	Rated Current In (A)	3 Pole		4 Pole	
			Type	Unit LP* ₹	Type	Unit LP* ₹
3VA20	36kA	25	3VA2025-4HM32-0AA0	36155.-	3VA2025-4HM42-0AA0	44570.-
		40	3VA2040-4HM32-0AA0	36155.-	3VA2040-4HM42-0AA0	44570.-
		63	3VA2063-4HM32-0AA0	36155.-	3VA2063-4HM42-0AA0	44570.-
		100	3VA2010-4HM32-0AA0	36155.-	3VA2010-4HM42-0AA0	44570.-
		160	3VA2116-4HM32-0AA0	45725.-	3VA2116-4HM42-0AA0	56950.-
		250	3VA2225-4HM32-0AA0	57785.-	3VA2225-4HM42-0AA0	72635.-
		400	3VA2340-4HM32-0AA0	77720.-	3VA2340-4HM42-0AA0	98030.-
3VA21	55kA	630	3VA2463-4HM32-0AA0	85495.-	3VA2463-4HM42-0AA0	107820.-
3VA22		25	3VA2025-5HM32-0AA0	41210.-	3VA2025-5HM42-0AA0	47220.-
3VA23		40	3VA2040-5HM32-0AA0	41210.-	3VA2040-5HM42-0AA0	47220.-
3VA24		63	3VA2063-5HM32-0AA0	41210.-	3VA2063-5HM42-0AA0	47220.-
3VA25		100	3VA2010-5HM32-0AA0	42060.-	3VA2010-5HM42-0AA0	49355.-
		160	3VA2116-5HM32-0AA0	56665.-	3VA2116-5HM42-0AA0	67995.-
		250	3VA2225-5HM32-0AA0	69105.-	3VA2225-5HM42-0AA0	86240.-
3VA26 NEW	400	3VA2340-5HM32-0AA0	83440.-	3VA2340-5HM42-0AA0	105250.-	
	630	3VA2463-5HM32-0AA0	91800.-	3VA2463-5HM42-0AA0	115760.-	
	800	3VA2580-5HM32-0AA0	133220.-	3VA2580-5HM42-0AA0	173190.-	
3VA20	85kA	1000	3VA2510-5HM32-0AA0	178965.-	3VA2510-5HM42-0AA0	234915.-
		1250	3VA2612-5HM32-0AA0	250360.-	3VA2612-5HM42-0AA0	330680.-
		25	3VA2025-6HM32-0AA0	51455.-	3VA2025-6HM42-0AA0	62575.-
		40	3VA2040-6HM32-0AA0	51455.-	3VA2040-6HM42-0AA0	62575.-
		63	3VA2063-6HM32-0AA0	51455.-	3VA2063-6HM42-0AA0	62575.-
		100	3VA2010-6HM32-0AA0	51455.-	3VA2010-6HM42-0AA0	62575.-
		160	3VA2116-6HM32-0AA0	65555.-	3VA2116-6HM42-0AA0	82285.-
		250	3VA2225-6HM32-0AA0	76775.-	3VA2225-6HM42-0AA0	107720.-
		400	3VA2340-6HM32-0AA0	93025.-	3VA2340-6HM42-0AA0	117995.-
		630	3VA2463-6HM32-0AA0	102325.-	3VA2463-6HM42-0AA0	129810.-
3VA25	800	3VA2580-6HM32-0AA0	150100.-	3VA2580-6HM42-0AA0	196280.-	
	1000	3VA2510-6HM32-0AA0	202500.-	3VA2510-6HM42-0AA0	266880.-	
3VA26 NEW	1250	3VA2612-6HM32-0AA0	284645.-	3VA2612-6HM42-0AA0	376710.-	

Std. Pkg. = 1 unit

* LP - List Price

SENTRON 3VA - Accessories

Frame	3VA1 100A/ 160A/ 250A/ 400A/ 630A/ 800A/ 1000A	Unit LP* ₹	3VA2 100A / 160A / 250A 3VA2 400A/630A/800A/1000A/1250A	Unit LP* ₹
Accessory	Type		Type	
Auxiliary switch (AUX)	3VA99880AA12 (1 C/O)	2030.-	3VA99880AA12 (1 C/O)	2030.-
Alarm switch (TAS)	3VA99880AB12 (1 C/O)	3130.-	3VA99880AB12 (1 C/O)	3130.-
Short-circuit Alarm switch (SAS) for 3VA1 Only	3VA99880AB32 (for 3VA10/ 11 100A/ 160A) 3VA99880AB34 (for 3VA12/ 13/ 14 250A/ 400A/ 630A)	1670.- 1670.-	-	-
Electrical alarm switches (EAS) for 3VA2 Only	-	-	3VA99880AB22	1670.-
Under voltage release (UVR)				
120-127 V AC 50/60 Hz	3VA99080BB24	4790.-	3VA99080BB24	4790.-
208-230 V AC 50/60 Hz	3VA99080BB25	4790.-	3VA99080BB25	4790.-
380-400 V AC 50/60 Hz	3VA99080BB26	4790.-	3VA99080BB26	4790.-
Shunt release flexible (STF)				
110-127 V AC 50/60 Hz	3VA99880BA22	3610.-	3VA99880BA22	3610.-
208-277 V AC 50/60 Hz	3VA99880BA23	3610.-	3VA99880BA23	3610.-
380-500 V AC 50/60 Hz	3VA99880BA24	3610.-	3VA99880BA24	3610.-
Shunt release left (STL)				
110-127 V AC 50/60 Hz	3VA99880BL32	3610.-	3VA99880BL32	3610.-
208-277 V AC 50/60 Hz	3VA99880BL33	3610.-	3VA99880BL33	3610.-
380-500 V AC 50/60 Hz	3VA99880BL20	3610.-	3VA99880BL20	3610.-
Extended Door Mounted Rotary Operator (including 8UC handle)	3VA9157-0FK51 (for 3VA10/ 11 100A/160A) 3VA9257-0FK51 (for 3VA12 250A) 3VA9467-0FK51 (for 3VA13/ 14 400/ 630A)	2695.- 2835.- 4445.-	3VA9267-0FK51 (for 3VA20/ 21/ 22 100A/ 160A/ 250A) 3VA9467-0FK51 (for 3VA23/ 24 400A/ 630A)	2835.- 4445.-
Extended Door Mounted Rotary Operator ^	3VA9687-0FK21 (for 3VA15 800/ 1000A)	10355.-	3VA9687-0FK21 (for 3VA25/26 800A/1000A/1250A)	10355.-
Illuminated - Door mounted rotary operator 24V DC	3VA9157-0FK23 (for 3VA10/ 11 100A/160A) 3VA9257-0FK23 (for 3VA12 250A) 3VA9467-0FK23 (for 3VA13/ 14 400A/ 630A) 3VA9687-0FK23 (for 3VA15 800A/1000A)	6180.- 6795.- 8640.- 12280.-	3VA9267-0FK23 (for 3VA20/ 21/ 22 100A/ 160A/ 250A) 3VA9467-0FK23 (for 3VA23/ 24 400A/ 630A) 3VA9687-0FK23 (for 3VA25/26 800A/1000A/1250A)	6795.- 8640.- 12280.-
Castell interlock kit* (for breakers with 8UC Handles) (To interlock two or more circuit breakers)	8UC60701YQ.. (for 3VA10/ 11/ 12/ 13/ 14)	4990.-	8UC60701YQ.. (for 3VA20/ 21/ 22/ 23/ 24)	4990.-
Sliding Bar Interlock (for same size breakers with Toggle Lever)	3VA91580VF30 (for 3VA10/ 11 100A/160A) 3VA92580VF30 (for 3VA12 250A) 3VA93680VF30 (for 3VA13/ 14 400A/ 630A)	6180.- 6415.- 7245.-	3VA91680VF30 (for 3VA20/ 21/ 22 100A/ 160A/ 250A) 3VA93680VF30 (for 3VA23/ 24 400A/ 630A)	6795.- 7245.-
Locking device for breaker with Toggle lever	3VA90880LB10 (3VA10/ 11/ 12 100A/ 160A/ 250A) 3VA93880LB10 (for 3VA13/ 14 400A/ 630A) 3VA95880LB10 (3VA15 800/ 1000A)	1890.- 2485.- 5365.-	3VA93880LB10 (for 3VA20/ 21/ 22/ 23/ 24 100A/ 160A/ 250A/ 400A/ 630A) 3VA95880LB10 (3VA25/26 800/ 1000/ 1250A)	2485.- 5365.-
Motorised drive - (Motorised operator - MO) 110-230V AC/ 110-250VDC	3VA91570HA20 (for 3VA11 160A) 3VA92570HA20 (for 3VA12 250A) 3VA94670HA20 (for 3VA13/ 14 400A/ 630A)	20750.- 27155.- 32060.-	3VA92670HA20 (for 3VA20/ 21/ 22 100A/ 160A/ 250A) 3VA94670HA20 (for 3VA23/ 24 400A/ 630A)	27155.- 32060.-
Spreader links - Broadened (with phase barriers)	3VA91530QC50 (for 3pole, 3VA10/ 11 100A/ 160A) 3VA91540QC50 (for 4pole, 3VA10/ 11 100A/ 160A) 3VA92530QC50 (for 3pole, 3VA12 250A) 3VA92540QC50 (for 4pole, 3VA12 250A) 3VA94830QC50 (for 3pole 3VA13/ 14 400A/ 630A) 3VA94840QC50 (for 4pole 3VA13/ 14 400A/ 630A)	1110.- 1425.- 1390.- 1845.- 1865.- 2415.-	3VA92630QC50 (for 3pole, 3VA20/ 21/ 22 100A/ 160A/ 250A) 3VA92640QC50 (for 4pole, 3VA20/ 21/ 22 100A/ 160A/ 250A) 3VA94830QC50 (for 3pole, 3VA23/ 24 400A/ 630A) 3VA94840QC50 (for 4pole, 3VA23/ 24 400A/ 630A)	1500.- 1960.- 1865.- 2415.-
Busbar extensions (with phase barriers)	3VA96030QB00 (for 3pole, 3VA15 800A/ 1000A) 3VA96040QB00 (for 4pole, 3VA15 800A/ 1000A)	5695.- 7605.-	3VA96030QB00 (for 3pole, 3VA25 800A/ 1000A) 3VA96040QB00 (for 4pole, 3VA25 800A/ 1000A)	5695.- 7605.-
Rear Terminals - Flat 1 set = 2 short + 1 Long (3pole) / 2 short + 2 Long (4pole)	3VA91130QE00 (for 3pole, 3VA10/ 11 100A/ 160A) 3VA91140QE00 (for 4pole, 3VA10/ 11 100A/ 160A) 3VA92130QE00 (for 3pole, 3VA12 250A) 3VA92140QE00 (for 4pole, 3VA12 250A) 3VA94030QE00 (for 3pole, 3VA13/ 14 400A/ 630A) 3VA94040QE00 (for 4pole, 3VA13/ 14 400A/ 630A)	2120.- 2865.- 2710.- 3630.- 4400.- 5865.-	3VA92030QE00 (for 3pole, 3VA20/ 21/ 22 100A/ 160A/ 250A) 3VA92040QE00 (for 4pole, 3VA20/ 21/ 22 100A/ 160A/ 250A) 3VA94030QE00 (for 3pole, 3VA23/ 24 400A/ 630A) 3VA94040QE00 (for 4pole, 3VA23/ 24 400A/ 630A)	2710.- 3630.- 4400.- 5865.-
Phase Barriers (1 set = 2 phase barriers)	3VA91520WA00 (for 3VA10/ 11 100A/ 160A) 3VA92520WA00 (for 3VA12 250A) 3VA94820WA00 (for 3VA13/ 14 400A/ 630A) 3VA96020WA00 (for 3VA15 800A/ 1000A)	405.- 405.- 950.- 955.-	3VA92620WA00 (for 3VA20/ 21/ 22 100A/ 160A/ 250A) 3VA94820WA00 (for 3VA23/ 24 400A/ 630A) 3VA96020WA00 (for 3VA25/26 800A/1000A/1250A)	405.- 950.- 955.-
3VA Adapter for mounting on 8US 60mm busbar system	8US1213-4AU01 (for 3pole, 3VA10/ 11) 8US1213-4AP03 (for 3-pole, 3VA12) 8US1213-4AH04 (for 3pole, 3VA13/ 14)	Price on request	8US1213-4AP03 (for 3VA20/ 21/ 22) 8US1213-4AH04 (for 3VA23/ 24)	Price on request

Notes:

The 11th and 12th place of the type reference will indicate the alphabet type of lock & key. Combinations available are A, B, C, D, A-, -B, -C, AB, AC. 11th place will be A, B, C, D for castell lock type A, B, C, D respectively. 11th and 12 place will be A0, 0B, 0C, AB, AC for castell lock type A-, -B, -C, AB, AC respectively

For higher breaking capacities (110kA and 150kA) and other special application MCCB, contact our nearest Sales Office.

For side mounted handles please contact our nearest Sales Office.

* 1 set contains rotary mechanism, coupler, shaft and 8UC Front drive.

Spreader link 1 set = 3 nos. links and 2 nos. phase barriers in case of 3 pole; and 4 nos. links and 3 nos. phase barriers in case of 4 pole.

1) Door mounted rotary handles are not available for 1pole/ 2pole 3VA1 MCCBs

^ 3VA2 800A/1000A/1250A, extended rotary operator imported version (with 8UD handles)

Standard packing of 3VA26 1250A MCCB includes spreaders & phase barriers

Std. Pkg. = 1 unit

* LP - List Price



SENTRON 3VA27 moulded case circuit breakers



- Line, motor, starter protection and non-automatic circuit breaker
- Rated currents 800A to 1600A (3pole/ 4pole)
- Fixed & Draw-out variants
- Toggle lever or Stored-energy Operator (factory fitted)
- Interchangeable ETU LI/ LSI/ LSIG protection
- Short-circuit breaking capacity 55kA to 110 kA @ 415 V AC
- Communication via Modbus TCP, Modbus RTU, PROFIBUS & PROFINET
- Metering function according to IEC 61557-12





SENTRON 3VA MCCB, Microprocessor Trip Unit, ETU320 LI, Ics = 100% Icu, 415VAC, 50Hz [§] (Fixed mounted)

Frame Size	Breaking Capacity @ 415VAC, 50Hz	Rated Current In (A)	3 Pole		4 Pole	
			Type	Unit LP* ₹	Type	Unit LP* ₹
3VA27	55kA	1250	3VA2712-5AB03-0AA0	252775.-	3VA2712-5AB13-0AA0	339980.-
		1600	3VA2716-5AB03-0AA0	349835.-	3VA2716-5AB13-0AA0	470780.-
	85kA	1250	3VA2712-6AB03-0AA0	277690.-	3VA2712-6AB13-0AA0	373715.-
		1600	3VA2716-6AB03-0AA0	384095.-	3VA2716-6AB13-0AA0	517490.-

SENTRON 3VA MCCB, Microprocessor Trip Unit, ETU360 LSIG, Ics = 100% Icu, 415VAC, 50Hz [§] (Fixed mounted)

Frame Size	Breaking Capacity @ 415VAC, 50Hz	Rated Current In (A)	3 Pole		4 Pole	
			Type	Unit LP* ₹	Type	Unit LP* ₹
3VA27	55kA	1250	3VA2712-5AD03-0AA0	273540.-	3VA2712-5AD13-0AA0	360220.-
		1600	3VA2716-5AD03-0AA0	370080.-	3VA2716-5AD13-0AA0	491020.-
	85kA	1250	3VA2712-6AD03-0AA0	297930.-	3VA2712-6AD13-0AA0	394475.-
		1600	3VA2716-6AD03-0AA0	404340.-	3VA2716-6AD13-0AA0	539810.-

Accessories for 3VA27

	Description	Type	Unit LP* ₹	Std. pkg. (nos.)
	Auxiliary switch (AUX)	3VW9011-0AG01	4675.-	1
	Alarm switch (TAS)	3VW9011-0AH14	2310.-	1
	Shunt release (ST)	3VW9011-0AD05 3VW9011-0AD07	10760.-	1
	Under voltage release (UVR)	3VW9011-0AE05 3VW9011-0AE07 3VW9011-0AE18	11650.-	1
	Extended Door Mounted Rotary Operator [^] (Standard - Gray)	3VW9727-0FK21	10355.-	1

[§] Toggle lever variants [^]3VA27 extended door mounted rotary operator (imported) with 8UD handles

All MCCBs are suitable for Front Terminals connection only.

Accessories can also be offered in factory fitted options

Please get in touch with nearest sales office for more Auxiliary combinations & choice of accessories

Std. Pkg. = 1 unit

* LP - List Price



3VM moulded case circuit breaker

Efficient. Powerful.

www.siemens.co.in

SIEMENS

MCCB: SENTRON 3VM

- Rated current: 16A to 630A
- 1 pole, 2 pole, 3 pole & 4 pole versions
- Breaking capacity: 16kA to 55kA
- Thermal magnetic trip unit (FTFM, ATFM, AM, FM)
- Switch disconnectors
- Common Internal accessories for the entire range
- Knowledge Manager (QR Code)



SENTRON 3VM, Thermal Magnetic Trip Unit, Fixed Thermal Fixed Magnetic (FTFM), 415VAC, 50Hz

Frame Size	Breaking Capacity @ 415VAC, 50Hz	Rated Current In (A)	3 Pole Type	Unit MRP [®] ₹	4 Pole Type	Unit MRP [®] ₹
3VM10	16kA	16	3VM10962ED320AA0	7960.-	3VM10962ED420AA0	10315.-
		20	3VM10202ED320AA0	7960.-	3VM10202ED420AA0	10315.-
		25	3VM10252ED320AA0	7960.-	3VM10252ED420AA0	10315.-
		32	3VM10322ED320AA0	7960.-	3VM10322ED420AA0	10315.-
		40	3VM10402ED320AA0	7960.-	3VM10402ED420AA0	10315.-
		50	3VM10502ED320AA0	7960.-	3VM10502ED420AA0	10315.-
		63	3VM10632ED320AA0	7960.-	3VM10632ED420AA0	10315.-
		80	3VM10802ED320AA0	8700.-	3VM10802ED420AA0	11295.-
3VM10	25kA	100	3VM10102ED320AA0	9440.-	3VM10102ED420AA0	12295.-
		16	3VM10963ED320AA0	8250.-	3VM10963ED420AA0	10770.-
		20	3VM10203ED320AA0	8250.-	3VM10203ED420AA0	10770.-
		25	3VM10253ED320AA0	8250.-	3VM10253ED420AA0	10770.-
		32	3VM10323ED320AA0	8250.-	3VM10323ED420AA0	10770.-
		40	3VM10403ED320AA0	8250.-	3VM10403ED420AA0	10770.-
		50	3VM10503ED320AA0	8250.-	3VM10503ED420AA0	10770.-
		63	3VM10633ED320AA0	8250.-	3VM10633ED420AA0	10770.-
3VM11		80	3VM10803ED320AA0	8980.-	3VM10803ED420AA0	11680.-
		100	3VM10103ED320AA0	9645.-	3VM10103ED420AA0	12550.-
		125	3VM11123ED320AA0	12360.-	3VM11123ED420AA0	16320.-
		160	3VM11163ED320AA0	16125.-	3VM11163ED420AA0	20415.-

Frame Size	Breaking Capacity @ 415VAC, 50Hz	Rated Current In (A)	3 Pole Type	Unit LP* ₹	4 Pole Type	Unit LP* ₹
3VM11	36kA	16	3VM11964ED320AA0	8705.-	3VM11964GD420AA0	12050.-
		20	3VM11204ED320AA0	8705.-	3VM11204GD420AA0	12050.-
		25	3VM11254ED320AA0	8705.-	3VM11254GD420AA0	12050.-
		32	3VM11324ED320AA0	8705.-	3VM11324GD420AA0	12050.-
		40	3VM11404ED320AA0	8705.-	3VM11404GD420AA0	12050.-
		50	3VM11504ED320AA0	8705.-	3VM11504GD420AA0	12050.-
		63	3VM11634ED320AA0	8705.-	3VM11634GD420AA0	12050.-
		80	3VM11804ED320AA0	9140.-	3VM11804GD420AA0	13215.-
		100	3VM11104ED320AA0	10605.-	3VM11104GD420AA0	15270.-
		125	3VM11124ED320AA0	18620.-	3VM11124GD420AA0	24205.-
3VM12		160	3VM11164ED320AA0	20570.-	3VM11164GD420AA0	26745.-
		200	3VM12204ED320AA0	22095.-	3VM12204GD420AA0	27350.-
3VM13		250	3VM12254ED320AA0	29470.-	3VM12254GD420AA0	34725.-
		320	3VM13324ED320AA0	39980.-	3VM13324GD420AA0	49440.-
3VM14		400	3VM13404ED320AA0	41035.-	3VM13404GD420AA0	50495.-
		500	3VM14504ED320AA0	45145.-	3VM14504GD420AA0	54605.-
		630	3VM14634ED320AA0	45145.-	3VM14634GD420AA0	54605.-

^ 3VM11 TMTU up to 160A

AM: Adjustable Magnetic

FM: Fixed Magnetic

Std. Pkg. = 1 unit

* LP - List Price

® MRP - Max. Retail Price

SETRON 3VM, Thermal Magnetic Trip Unit, Fixed Thermal Fixed Magnetic (FTFM), 415VAC, 50Hz (Contd.)

Frame Size	Breaking Capacity @ 415VAC, 50Hz	Rated Current In (A)	3 Pole Type	Unit LP* ₹	4 Pole Type	Unit LP* ₹
3VM11	55kA	16	3VM11965ED320AA0	10005.-	3VM11965GD420AA0	12980.-
		20	3VM11205ED320AA0	10005.-	3VM11205GD420AA0	12980.-
		25	3VM11255ED320AA0	10005.-	3VM11255GD420AA0	12980.-
		32	3VM11325ED320AA0	10005.-	3VM11325GD420AA0	12980.-
		40	3VM11405ED320AA0	10005.-	3VM11405GD420AA0	12980.-
		50	3VM11505ED320AA0	10005.-	3VM11505GD420AA0	12980.-
		63	3VM11635ED320AA0	10005.-	3VM11635GD420AA0	12980.-
		80	3VM11805ED320AA0	10965.-	3VM11805GD420AA0	14250.-
		100	3VM11105ED320AA0	12700.-	3VM11105GD420AA0	16480.-
		125	3VM11125ED320AA0	20465.-	3VM11125GD420AA0	26600.-
		160	3VM11165ED320AA0	22605.-	3VM11165GD420AA0	29415.-
3VM12		200	3VM12205ED320AA0	24455.-	3VM12205GD420AA0	30985.-
		250	3VM12255ED320AA0	31830.-	3VM12255GD420AA0	38365.-
3VM13		320	3VM13325ED320AA0	43355.-	3VM13325GD420AA0	52045.-
		400	3VM13405ED320AA0	44420.-	3VM13405GD420AA0	53105.-
3VM14		500	3VM14505ED320AA0	48520.-	3VM14505GD420AA0	57205.-
		630	3VM14635ED320AA0	48520.-	3VM14635GD420AA0	57205.-

An extensive portfolio of connection components....

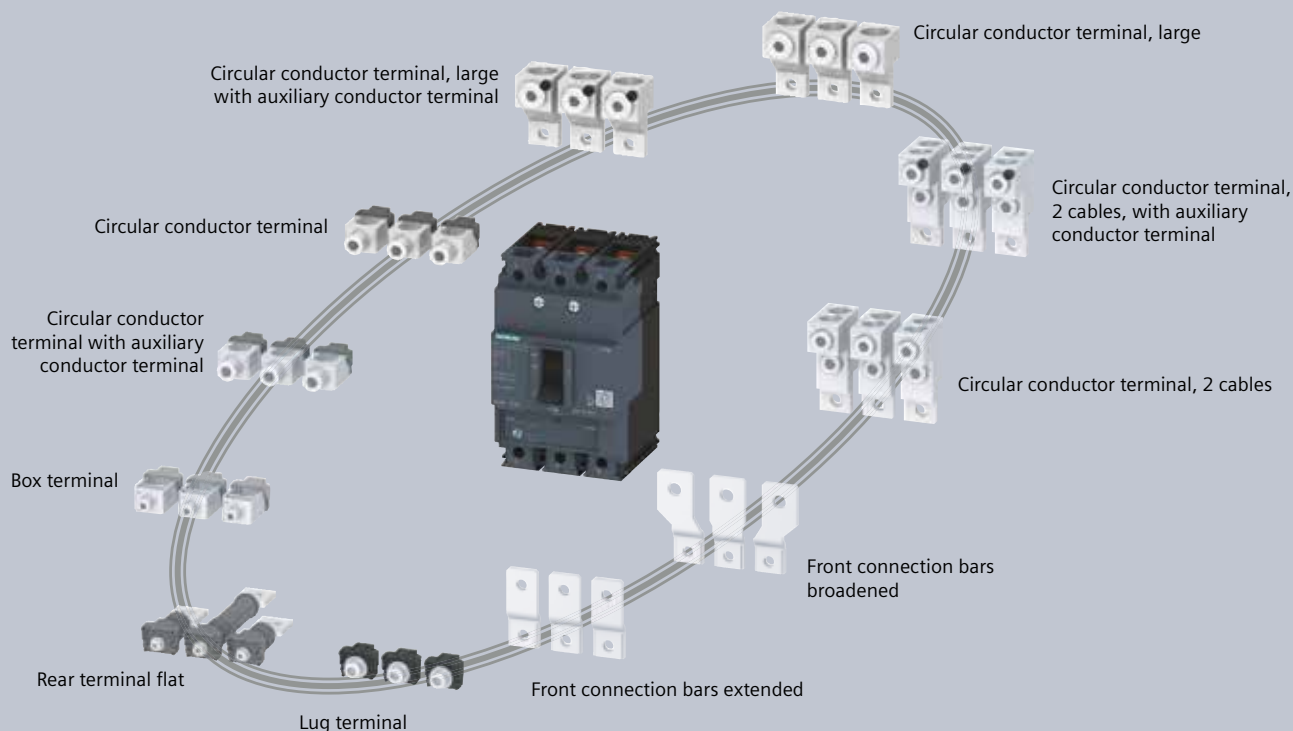

..to meet ALL installation requirements.

Std. Pkg. = 1 unit

* LP - List Price

SENTRON 3VM, Thermal Magnetic Trip Unit, Adj. Thermal Fixed Magnetic (ATFM), 415VAC, 50Hz

Frame Size	Breaking Capacity @ 415VAC, 50Hz	Rated Current In (A)	3 Pole Type	Unit LP* ₹	4 Pole Type	Unit LP* ₹
3VM11	25kA	16	3VM11963EE320AA0	9795.-	3VM11963GE420AA0	14770.-
		20	3VM11203EE320AA0	9795.-	3VM11203GE420AA0	14770.-
		25	3VM11253EE320AA0	9795.-	3VM11253GE420AA0	14770.-
		32	3VM11323EE320AA0	9795.-	3VM11323GE420AA0	14770.-
		40	3VM11403EE320AA0	9795.-	3VM11403GE420AA0	14770.-
		50	3VM11503EE320AA0	9795.-	3VM11503GE420AA0	14770.-
		63	3VM11633EE320AA0	9795.-	3VM11633GE420AA0	14770.-
		80	3VM11803EE320AA0	9795.-	3VM11803GE420AA0	14770.-
		100	3VM11103EE320AA0	9795.-	3VM11103GE420AA0	14770.-
		125	3VM11123EE320AA0	12650.-	3VM11123GE420AA0	17300.-
		160	3VM11163EE320AA0	17400.-	3VM11163GE420AA0	22150.-
3VM11	36kA	16	3VM11964EE320AA0	12670.-	3VM11964GE420AA0	16590.-
		20	3VM11204EE320AA0	12670.-	3VM11204GE420AA0	16590.-
		25	3VM11254EE320AA0	12670.-	3VM11254GE420AA0	16590.-
		32	3VM11324EE320AA0	12670.-	3VM11324GE420AA0	16590.-
		40	3VM11404EE320AA0	12670.-	3VM11404GE420AA0	16590.-
		50	3VM11504EE320AA0	12670.-	3VM11504GE420AA0	16590.-
		63	3VM11634EE320AA0	12670.-	3VM11634GE420AA0	16590.-
		80	3VM11804EE320AA0	12670.-	3VM11804GE420AA0	16590.-
		100	3VM11104EE320AA0	12670.-	3VM11104GE420AA0	16590.-
		125	3VM11124EE320AA0	19505.-	3VM11124GE420AA0	24840.-
		160	3VM11164EE320AA0	21135.-	3VM11164GE420AA0	27435.-
3VM12		200	3VM12204EE320AA0	30570.-	3VM12204GE420AA0	35670.-
		250	3VM12254EE320AA0	30570.-	3VM12254GE420AA0	35670.-
3VM13		320	3VM13324EE320AA0	40920.-	3VM13324GE420AA0	50100.-
		400	3VM13404EE320AA0	40920.-	3VM13404GE420AA0	50100.-
3VM14		500	3VM14504EE320AA0	46745.-	3VM14504GE420AA0	55920.-
		630	3VM14634EE320AA0	46745.-	3VM14634GE420AA0	55920.-
3VM11	55kA	16	3VM11965EE320AA0	14440.-	3VM11965GE420AA0	18245.-
		20	3VM11205EE320AA0	14440.-	3VM11205GE420AA0	18245.-
		25	3VM11255EE320AA0	14440.-	3VM11255GE420AA0	18245.-
		32	3VM11325EE320AA0	14440.-	3VM11325GE420AA0	18245.-
		40	3VM11405EE320AA0	14440.-	3VM11405GE420AA0	18245.-
		50	3VM11505EE320AA0	14440.-	3VM11505GE420AA0	18245.-
		63	3VM11635EE320AA0	14440.-	3VM11635GE420AA0	18245.-
		80	3VM11805EE320AA0	14440.-	3VM11805GE420AA0	18245.-
		100	3VM11105EE320AA0	14440.-	3VM11105GE420AA0	18245.-
		125	3VM11125EE320AA0	22670.-	3VM11125GE420AA0	27230.-
		160	3VM11165EE320AA0	23245.-	3VM11165GE420AA0	29995.-
3VM12		200	3VM12205EE320AA0	32850.-	3VM12205GE420AA0	39195.-
		250	3VM12255EE320AA0	32850.-	3VM12255GE420AA0	39195.-
3VM13		320	3VM13325EE320AA0	44200.-	3VM13325GE420AA0	52625.-
		400	3VM13405EE320AA0	44200.-	3VM13405GE420AA0	52625.-
3VM14		500	3VM14505EE320AA0	50015.-	3VM14505GE420AA0	58445.-
		630	3VM14635EE320AA0	50015.-	3VM14635GE420AA0	58445.-

Circuit Breakers

Std. Pkg. = 1 unit

* LP - List Price

SETRON 3VM, Motor Starter Protection, 3pole, Adjustable Magnetic (AM) trip unit

Frame Size	Rated Current In (A)	Breaking Capacity (55kA, 415V, 50Hz)	Unit LP* ₹
3VM11	8 ¹⁾	3VM11085MG320AA0	12580.-
	12.5 ¹⁾	3VM11925MG320AA0	12580.-
	20	3VM11205MH320AA0	12580.-
	32	3VM11325MH320AA0	15025.-
	40	3VM11405MH320AA0	15025.-
	50	3VM11505MH320AA0	15025.-
	63	3VM11635MH320AA0	15025.-
	80	3VM11805MH320AA0	15025.-
	100	3VM11105MH320AA0	15025.-
	125	3VM11125MH320AA0	22365.-
3VM12	160	3VM12165MH320AA0	22365.-
	200	3VM12205MH320AA0	33930.-
3VM13	250	3VM13255MH320AA0	33930.-
	320	3VM13325MH320AA0	48620.-
3VM14	400	3VM14405MH320AA0	48620.-
	500	3VM14505MH320AA0	53890.-



SETRON 3VM, Switch Disconnecter (without protection)

Frame Size	Rated Current In (A)	3pole Type	Unit LP* ₹	4pole Type	Unit LP* ₹
3VM11	63	3VM11631AA320AA0	9385.-	3VM11631AA420AA0	13865.-
	100	3VM11101AA320AA0	9385.-	3VM11101AA420AA0	13865.-
	125	3VM11121AA320AA0	13690.-	3VM11121AA420AA0	17235.-
	160	3VM11161AA320AA0	13690.-	3VM11161AA420AA0	17235.-
3VM12	250	3VM12251AA320AA0	22790.-	3VM12251AA420AA0	30395.-
3VM13	400	3VM13401AA320AA0	29405.-	3VM13401AA420AA0	38230.-

¹⁾ Fixed magnetic

3VM Plug in Portfolio

16A-630A, 3P & 4P



3VM MCCB



Plug in kit

Plug in technology



Easy to handle



Quick Replacement



Safe Installation

Available as complete kit and/or conversion kit. Kindly contact nearest Sales office for further information.

SENTRON 3VM, Thermal Magnetic Trip Unit, Fixed Thermal Fixed Magnetic (FTFM)

Frame Size	Breaking Capacity	Rated Current In (A)	1 Pole Type	Unit LP* ₹	2 Pole Type	Unit LP* ₹
3VM11	25kA ¹⁾	16	3VM11963ED120AA0	3660.-	3VM11963ED220AA0	6565.-
		20	3VM11203ED120AA0	3660.-	3VM11203ED220AA0	6565.-
		25	3VM11253ED120AA0	3660.-	3VM11253ED220AA0	6565.-
		32	3VM11323ED120AA0	3660.-	3VM11323ED220AA0	6565.-
		40	3VM11403ED120AA0	3660.-	3VM11403ED220AA0	6565.-
		50	3VM11503ED120AA0	3660.-	3VM11503ED220AA0	6565.-
		63	3VM11633ED120AA0	3660.-	3VM11633ED220AA0	6565.-
		80	3VM11803ED120AA0	4030.-	3VM11803ED220AA0	7195.-
		100	3VM11103ED120AA0	4650.-	3VM11103ED220AA0	8430.-
		125	3VM11123ED120AA0	7510.-	3VM11123ED220AA0	13640.-
		160	3VM11163ED120AA0	8745.-	3VM11163ED220AA0	15750.-
3VM11	36kA ¹⁾	16	3VM11964ED120AA0	3965.-	3VM11964ED220AA0	7195.-
		20	3VM11204ED120AA0	3965.-	3VM11204ED220AA0	7195.-
		25	3VM11254ED120AA0	3965.-	3VM11254ED220AA0	7195.-
		32	3VM11324ED120AA0	3965.-	3VM11324ED220AA0	7195.-
		40	3VM11404ED120AA0	3965.-	3VM11404ED220AA0	7195.-
		50	3VM11504ED120AA0	3965.-	3VM11504ED220AA0	7195.-
		63	3VM11634ED120AA0	3965.-	3VM11634ED220AA0	7195.-
		80	3VM11804ED120AA0	4405.-	3VM11804ED220AA0	7940.-
		100	3VM11104ED120AA0	4740.-	3VM11104ED220AA0	9175.-
		125	3VM11124ED120AA0	8130.-	3VM11124ED220AA0	14625.-
		160	3VM11164ED120AA0	9480.-	3VM11164ED220AA0	17110.-

¹⁾ 1pole : Icu 25kA/ 36kA @ 240VAC, 2pole : Icu 25kA/ 36kA @ 415VAC

Earth fault protection for SENTRON 3VM moulded case circuit breaker

Description	Type	Unit LP* ₹
Earth fault monitoring relay	7UG0861-1BU20	5120.-
CBCT for EFR: 160 frame Suitable for 3VM10/11	3P	7UG09910
	4P	7UG09911
CBCT for EFR: 250 frame Suitable for 3VM12	3P	7UG09912
	4P	7UG09913
CBCT for EFR: 630 frame Suitable for 3VM13/14	3P	7UG09914
	4P	7UG09915

Earth leakage protection for SENTRON 3VM moulded case circuit breaker

Description	Type	Unit LP* ₹
Earth leakage relay 1Ph-2W, 3Ph-3W, 3Ph-4W	110VAC	7UG0841-1CB20
	230VAC	7UG0842-1CD20
CBCT for ELR	35 mm dia	7UG0996
	70 mm dia	7UG0997
	120 mm dia	7UG0999
	210 mm dia	7UG0994
	310 mm dia	7UG0995

Note: Order 1 no of shunt trip release for MCCB separately along with earth fault relay / earth leakage relay

Std. Pkg. = 1 unit

* LP - List Price

Internal accessories for SENTRON 3VM10/11/12/13/14 100A-630A

MLFB	Description	Unit LP*₹
Auxiliary Switches and Alarm Switches (1 C/O)		
3VM9988-0AA12	Auxiliary Switch AUX (1 C/O)	1575.-
3VM9988-0AB12	Trip Alarm Switch TAS (1 C/O)	1575.-
Undervoltage releases		
3VM9908-0BB11	UVR 24V DC	3515.-
3VM9908-0BB12	UVR 48V DC	3515.-
3VM9908-0BB23	UVR 110 V AC 50/60HZ	3515.-
3VM9908-0BB25	UVR 208-230 V AC 50/60 HZ	3515.-
3VM9908-0BB26	UVR 380-400 V AC 50/60 HZ	3515.-
Shunt release (Left)		
3VM9908-0BL30	STL 24V AC 50/60Hz / 12-30V DC	2845.-
3VM9908-0BL31	STL 48-60V AC 50/60Hz/ DC	2845.-
3VM9908-0BL32	STL 110-127 V AC 50/60 HZ / DC	2845.-
3VM9908-0BL33	STL 208-277 V AC 50/60 HZ / 220-250 V DC	2845.-
3VM9908-0BL20	STL 380-600 V AC 50/60 HZ	2845.-

External Accessories:

MLFB	Description	Unit LP*₹
Rotary Handles ¹⁾		
3VM9117-0FK51 [®]	Door mounted Rotary Operator with 8UC drive, Standard, 3VM10/ 11	2000.-
3VM9217-0FK51 [®]	Door mounted Rotary Operator with 8UC drive, Standard, 3VM12	2530.-
3VM9417-0FK51 [®]	Door mounted Rotary Operator with 8UC drive, Standard, 3VM13/ 14	2730.-
3VM9117-0EK21	Direct mounted Rotary Operator (Grey), Standard, 3VM10/ 11	1980.-
3VM9217-0EK21	Direct mounted Rotary Operator (Grey), Standard, 3VM12	2600.-
3VM9417-0EK21	Direct mounted Rotary Operator (Grey), Standard, 3VM13/ 14	2870.-
Spreaders (incl. Phase barriers)		
3VM9153-0QC50	Spreader links - Broadened, 3pole, 3VM10/ 11	1110.-
3VM9154-0QC50	Spreader links - Broadened, 4pole, 3VM10/ 11	1425.-
3VM9253-0QC50	Spreader links - Broadened, 3pole, 3VM12	1390.-
3VM9254-0QC50	Spreader links - Broadened, 4pole, 3VM12	1845.-
3VM9483-0QC50	Spreader links - Broadened, 3pole, 3VM13/ 14	1865.-
3VM9484-0QC50	Spreader links - Broadened, 4pole, 3VM13/ 14	2415.-
Extended terminals (incl. Phase barriers)		
3VM9253-0QB50	Extended terminals, 3pole, 3VM12	935.-
3VM9254-0QB50	Extended terminals, 4pole, 3VM12	1245.-
3VM9483-0QB50	Extended terminals, 3pole, 3VM13/ 14	1260.-
3VM9484-0QB50	Extended terminals, 4pole, 3VM13/ 14	1640.-
Phase barriers		
3VM9152-0WA00	Phase barriers (1set = 2 phase barriers), 3VM10/ 11	660.-
3VM9252-0WA00	Phase barriers (1set = 2 phase barriers), 3VM12	920.-
3VM9482-0WA00	Phase barriers (1set = 2 phase barriers), 3VM13/ 14	920.-
Locking device for breaker with Toggle lever		
3VM9188-0LB10	Locking device for: 3VM10/ 11/ 12	1755.-
3VM9388-0LB10	Locking device for: 3VM13/ 14	2305.-
Interlocking (for MCCBs with 8UC handles)		
8UC60701YQ.. #	Castell interlock kit for 3VM10/ 11/ 12/ 13/ 14	4990.-



Notes:

The 11th and 12th place of the type reference will indicate the alphabet type of lock & key. Combinations available are A, B, C, D, A-, -B, -C, AB, AC. 11th place will be A, B, C, D for castell lock type A, B, C, D respectively. 11th and 12th place will be A0, 0B, 0C, AB, AC for castell lock type A-, -B, -C, AB, AC respectively

[®] 1 set contains rotary mechanism, coupler, shaft and 8UC Front drive.

Spreader link 1 set = 3 nos. links and 2 nos. phase barriers in case of 3 pole; and 4 nos. links and 3 nos. phase barriers in case of 4 pole.

¹⁾ Rotary handles are not available for 1pole/ 2pole 3VM1 MCCBs

Std. Pkg. = 1 unit

* LP - List Price

3VT2..3

Main switching unit without Trip Unit (ETU)

To be ordered along with trip unit

Frame Size	Breaking capacity (I _{cu} , 415V AC, 50Hz)	Rated current I _n (A)	3 pole		4 pole		Std. pkg. (nos.)
			Type	Unit LP* ₹	Type	Unit LP* ₹	
3VT2	36 kA	250	3VT2725-2AA36-0AA0	11945.-	3VT2725-2AA46-0AA0	18560.-	1
3VT3		630	3VT3763-2AA36-0AA0	29165.-	3VT3763-2AA46-0AA0	41080.-	1
3VT2	65 kA	250	3VT2725-3AA36-0AA0	14910.-	3VT2725-3AA46-0AA0	23145.-	1
3VT3		630	3VT3763-3AA36-0AA0	33415.-	3VT3763-3AA46-0AA0	44355.-	1



Microprocessor based Trip Unit (ETU)

To be ordered along with the MCCB Main switching unit

Trip unit for system protection ETU LP, LI function (Fixed Overload & Fixed Short Circuit, 3P / 4P)

Frame size	Rated current I _n (A)	Type	Unit LP* ₹	Std. pkg. (nos.)
3VT2	160	3VT9216-6AB00	10590.-	1
	200	3VT9220-6AB00	15880.-	1
	250	3VT9225-6AB00	25175.-	1
3VT3	315	3VT9331-6AB00	21195.-	1
	400	3VT9340-6AB00	22530.-	1
	630	3VT9363-6AB00	27700.-	1

Trip unit for Motor & Generator Protection ETU MP, LI function (Adj Overload & Adj Short Circuit Settings 3P / 4P)

Frame size	Rated current I _n (A)	Type	Unit LP* ₹	Std. pkg. (nos.)
3VT2	160	3VT9216-6AP00	13255.-	1
	250	3VT9225-6AP00	27825.-	1
3VT3	400	3VT9340-6AP00	27825.-	1
	630	3VT9363-6AP00	34460.-	1

Trip unit for system protection ETU DP, LI function (Adj Overload & Adj Short Circuit, 3P / 4P)^s

Frame size	Rated current I _n (A)	Type	Unit LP* ₹	Std. pkg. (nos.)
3VT2	100	3VT9210-6AC00	9355.-	1
	160	3VT9216-6AC00	13120.-	1
	250	3VT9225-6AC00	27755.-	1
3VT3	400	3VT9340-6AC00	23980.-	1
	630	3VT9363-6AC00	31535.-	1

Benefits of interchangeable trip units

- Suitable for various applications
- Easy upgradation at site

Accessories for 3VT2..3

Accessory		3VT2 Type	Unit LP* ₹	3VT3 Type	Unit LP* ₹
Auxiliary Switch		3VT9300-2AF10 (1NO+1NC)	2990.-	3VT9300-2AF10 (1NO+1NC)	2990.-
		3VT9300-2AC10 (1NO)	1505.-	3VT9300-2AC10 (1NO)	1505.-
Alarm Switch		3VT9300-2AD10 (1NC)	1505.-	3VT9300-2AD10 (1NC)	1505.-
Shunt Release	AC 230V/DC 220V	3VT9300-1SE00\$	3385.-	3VT9300-1SE00\$	3385.-
Under-voltage Release	AC 230V/DC 220V	3VT9300-1UE00\$	4100.-	3VT9300-1UE00\$	4100.-
Spreader Links [*]	3 pole (1 set = 3 links + 2 phase barriers)	3VT9200-4ED30-ORC1	1390.-	3VT9300-4ED30-ORC1	1865.-
	4 pole (1 set = 4 links + 3 phase barriers)	3VT9200-4ED40-ORC1	1845.-	3VT9300-4ED40-ORC1	2415.-
Panel door mounted rotary operating handles ²	1 set **	3VT9200-3HQ00	2785.-	3VT9300-3HQ00	3000.-

Available till stocks last 3VT2..3 (Main Switching Unit + ETU) & accessories

\$ Also suitable for 400/500V AC

** 1 set contains rotary mechanism, coupler, shaft and door drive

* spreaders with higher phase-to-phase clearance

MCCB: SENTRON 3VT4...5

- Rated current - 800A to 1600A
- Microprocessor based trip unit
- Adjustable settings
- Suitable for various applications
- Inbuilt extended terminals
- Higher clearances



Main switching unit without Trip Unit (ETU)

To be ordered along with trip unit

Microprocessor based Trip Unit (ETU)

To be ordered along with the MCCB Main switching unit



Trip unit for system protection ETU DP, LI function (Adj Overload & Adj Short Circuit)

Frame Size	Breaking capacity (Icu, 415V AC, 50Hz)	Rated current I _n (A)	3 pole	
			Type	Unit LP* ₹
3VT4	65 kA	1000	3VT4710-3AA30-0AA0	55440.-
3VT5	55 kA	1600	3VT5716-3AA30-0AA0	83170.-

Frame size	Rated current I _n (A)	Type	Unit LP* ₹
3VT4	800	3VT9480-6AC00	26245.-
	1000	3VT9410-6AC00	82655.-
3VT5	1250	3VT9512-6AC00	89530.-
	1600	3VT9516-6AC00	151515.-

Accessories for 3VT4...5

Accessory		3VT4/5 Type	Unit LP* ₹
Auxiliary Switch		3VT9500-2AF10 (2NO+2NC)	4960.-
Alarm Switch		3VT9500-2AF10 (2NO+2NC)	4960.-
Shunt Release AC 230V/ DC 220V		3VT9500-1SJ00	3740.-

Accessory		3VT4/5 Type	Unit LP* ₹
Under-voltage Release AC 230V/ DC 220V		3VT9500-1UJ00	4060.-
Panel door mounted rotary operating handles 1 set **		3VT9500-3HQ00	6375.-
Castell Interlock Kit ¹ 1 set (1 lock + 1 key)		8UC60702YQ..	5125.-

** 1 set contains rotary mechanism, coupler, shaft and door drive

¹ The 11th and 12th place of the type reference will indicate the alphabet type of lock & key. Combinations available are A, B, C, D, A-, -B, -C, AB, AC. 11th place will be A, B, C, D for castell lock type A, B, C, D respectively. 11th and 12 place will be A0, 0B, 0C, AB, AC for castell lock type A-, -B, -C, AB, AC respectively.

Main switching unit + Trip unit

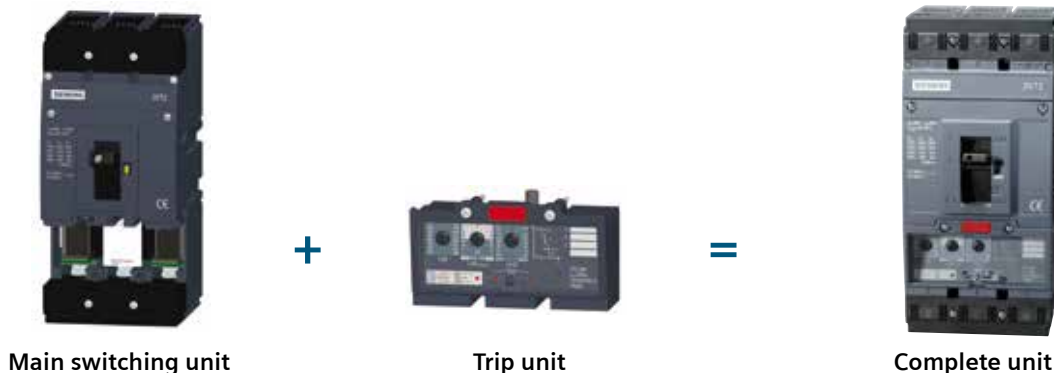

Main switching unit

Trip unit

Complete unit



SINOVA

3VJ Moulded Case Circuit Breakers

Simply Efficient

- Rated current: 20A to 400A
- 1 pole, 2 pole, 3 pole & 4 pole versions
- Breaking capacity: 10kA to 55kA
- Thermal magnetic trip unit (FTFM, ATFM)
- Range of internal and external accessories

www.siemens.co.in

SIEMENS

3VJ Moulded Case Circuit Breaker

NEW

3VJ10 MCCB, Thermal Magnetic Trip Unit, Fixed Thermal Fixed Magnetic (FTFM), 415VAC, 50Hz

Frame Size	Breaking Capacity @415V AC, 50/60Hz	Rated Current In (A)	2 Pole Type	Unit MRP* ₹	3 Pole Type	Unit MRP* ₹	4 Pole Type	Unit MRP* ₹
3VJ10 (VJ1 125X)	10kA	20	3VJ1002-0DA22-0AA0	2685.-	3VJ1002-0DA32-0AA0	3325.-	3VJ1002-0EA42-0AA0	4765.-
		25	3VJ1092-0DA22-0AA0	2685.-	3VJ1092-0DA32-0AA0	3325.-	3VJ1092-0EA42-0AA0	4765.-
		32	3VJ1003-0DA22-0AA0	2685.-	3VJ1003-0DA32-0AA0	3325.-	3VJ1003-0EA42-0AA0	4765.-
		40	3VJ1004-0DA22-0AA0	2685.-	3VJ1004-0DA32-0AA0	3325.-	3VJ1004-0EA42-0AA0	4765.-
		50	3VJ1005-0DA22-0AA0	2685.-	3VJ1005-0DA32-0AA0	3325.-	3VJ1005-0EA42-0AA0	4765.-
		63	3VJ1006-0DA22-0AA0	2685.-	3VJ1006-0DA32-0AA0	3325.-	3VJ1006-0EA42-0AA0	4765.-
		80	3VJ1008-0DA22-0AA0	2685.-	3VJ1008-0DA32-0AA0	3325.-	3VJ1008-0EA42-0AA0	4765.-
		100	3VJ1010-0DA22-0AA0	2685.-	3VJ1010-0DA32-0AA0	3325.-	3VJ1010-0EA42-0AA0	4765.-
		125	3VJ1012-0DA22-0AA0	4140.-	3VJ1012-0DA32-0AA0	4985.-	3VJ1012-0EA42-0AA0	7155.-
	18kA	20	3VJ1002-1DA22-0AA0	3705.-	3VJ1002-1DA32-0AA0	5345.-	3VJ1002-1EA42-0AA0	6860.-
		25	3VJ1092-1DA22-0AA0	3705.-	3VJ1092-1DA32-0AA0	5345.-	3VJ1092-1EA42-0AA0	6860.-
		32	3VJ1003-1DA22-0AA0	3705.-	3VJ1003-1DA32-0AA0	5345.-	3VJ1003-1EA42-0AA0	6860.-
		40	3VJ1004-1DA22-0AA0	3705.-	3VJ1004-1DA32-0AA0	5345.-	3VJ1004-1EA42-0AA0	6860.-
		50	3VJ1005-1DA22-0AA0	3705.-	3VJ1005-1DA32-0AA0	5345.-	3VJ1005-1EA42-0AA0	6860.-
		63	3VJ1006-1DA22-0AA0	3705.-	3VJ1006-1DA32-0AA0	5345.-	3VJ1006-1EA42-0AA0	6860.-
		80	3VJ1008-1DA22-0AA0	3705.-	3VJ1008-1DA32-0AA0	5345.-	3VJ1008-1EA42-0AA0	6860.-
		100	3VJ1010-1DA22-0AA0	3705.-	3VJ1010-1DA32-0AA0	5345.-	3VJ1010-1EA42-0AA0	6860.-
		125	3VJ1012-1DA22-0AA0	4290.-	3VJ1012-1DA32-0AA0	6130.-	3VJ1012-1EA42-0AA0	7975.-
	25kA	20	3VJ1002-3DA22-0AA0	4445.-	3VJ1002-3DA32-0AA0	5835.-	3VJ1002-3EA42-0AA0	7735.-
		25	3VJ1092-3DA22-0AA0	4445.-	3VJ1092-3DA32-0AA0	5835.-	3VJ1092-3EA42-0AA0	7735.-
		32	3VJ1003-3DA22-0AA0	4445.-	3VJ1003-3DA32-0AA0	5835.-	3VJ1003-3EA42-0AA0	7735.-
		40	3VJ1004-3DA22-0AA0	4445.-	3VJ1004-3DA32-0AA0	5835.-	3VJ1004-3EA42-0AA0	7735.-
		50	3VJ1005-3DA22-0AA0	4445.-	3VJ1005-3DA32-0AA0	5835.-	3VJ1005-3EA42-0AA0	7735.-
		63	3VJ1006-3DA22-0AA0	4445.-	3VJ1006-3DA32-0AA0	5835.-	3VJ1006-3EA42-0AA0	7735.-
		80	3VJ1008-3DA22-0AA0	4445.-	3VJ1008-3DA32-0AA0	5835.-	3VJ1008-3EA42-0AA0	7735.-
		100	3VJ1010-3DA22-0AA0	4445.-	3VJ1010-3DA32-0AA0	5835.-	3VJ1010-3EA42-0AA0	7735.-
		125	3VJ1012-3DA22-0AA0	4445.-	3VJ1012-3DA32-0AA0	6665.-	3VJ1012-3EA42-0AA0	8505.-

Notes:

Phase barriers are included in the standard MCCB packing

^2P in 3P Frame Size

Std. Pkg. = 1 unit

* MRP - Max. Retail Price



3VJ MCCB, Thermal Magnetic Trip Unit, Fixed Thermal Fixed Magnetic (FTFM), 415VAC, 50Hz

NEW

Frame Size	Breaking Capacity @415V AC, 50/60Hz	Rated Current In (A)	2 Pole Type	Unit MRP* ₹	3 Pole Type	Unit MRP* ₹	4 Pole Type	Unit MRP* ₹
3VJ12 (VJ1 250)	25kA	160	3VJ1216-3DA22-0AA0	9030.-	3VJ1216-3DA32-0AA0	10475.-	3VJ1216-3EA42-0AA0	13780.-
		200	3VJ1220-3DA22-0AA0	9130.-	3VJ1220-3DA32-0AA0	10635.-	3VJ1220-3EA42-0AA0	15125.-
		250	3VJ1225-3DA22-0AA0	9230.-	3VJ1225-3DA32-0AA0	11965.-	3VJ1225-3EA42-0AA0	15755.-
3VJ13 (VJ1 400)	25kA	320	-	-	3VJ1332-3DA32-0AA0	23710.-	3VJ1332-3EA42-0AA0	30530.-
		400	-	-	3VJ1340-3DA32-0AA0	23710.-	3VJ1340-3EA42-0AA0	30530.-
3VJ11 (VJ1 125)	36kA	25	3VJ1192-5DA22-0AA0	6840.-	3VJ1192-5DA32-0AA0	8140.-	3VJ1192-5EA42-0AA0	10755.-
		32	3VJ1103-5DA22-0AA0	6840.-	3VJ1103-5DA32-0AA0	8140.-	3VJ1103-5EA42-0AA0	10755.-
		40	3VJ1104-5DA22-0AA0	6840.-	3VJ1104-5DA32-0AA0	8140.-	3VJ1104-5EA42-0AA0	10755.-
		50	3VJ1105-5DA22-0AA0	6840.-	3VJ1105-5DA32-0AA0	8140.-	3VJ1105-5EA42-0AA0	10755.-
		63	3VJ1106-5DA22-0AA0	6840.-	3VJ1106-5DA32-0AA0	8140.-	3VJ1106-5EA42-0AA0	10755.-
		80	3VJ1108-5DA22-0AA0	6840.-	3VJ1108-5DA32-0AA0	8385.-	3VJ1108-5EA42-0AA0	11085.-
		100	3VJ1110-5DA22-0AA0	6840.-	3VJ1110-5DA32-0AA0	8385.-	3VJ1110-5EA42-0AA0	11085.-
3VJ12 (VJ1 250)	36kA	125	3VJ1112-5DA22-0AA0	6840.-	3VJ1112-5DA32-0AA0	9220.-	3VJ1112-5EA42-0AA0	12055.-
		160	3VJ1216-5DA22-0AA0	9530.-	3VJ1216-5DA32-0AA0	11730.-	3VJ1216-5EA42-0AA0	14260.-
		200	3VJ1220-5DA22-0AA0	10035.-	3VJ1220-5DA32-0AA0	14460.-	3VJ1220-5EA42-0AA0	18660.-
3VJ13 (VJ1 400)	36kA	250	3VJ1225-5DA22-0AA0	11325.-	3VJ1225-5DA32-0AA0	16620.-	3VJ1225-5EA42-0AA0	21390.-
		320	-	-	3VJ1332-5DA32-0AA0	24300.-	3VJ1332-5EA42-0AA0	31125.-
3VJ13 (VJ1 400)	36kA	400	-	-	3VJ1340-5DA32-0AA0	24300.-	3VJ1340-5EA42-0AA0	31125.-
		25	3VJ1192-7DA22-0AA0	7205.-	3VJ1192-7DA32-0AA0	10415.-	3VJ1192-7EA42-0AA0	13740.-
3VJ11 (VJ1 125)	55kA	32	3VJ1103-7DA22-0AA0	7205.-	3VJ1103-7DA32-0AA0	10415.-	3VJ1103-7EA42-0AA0	13740.-
		40	3VJ1104-7DA22-0AA0	7205.-	3VJ1104-7DA32-0AA0	10415.-	3VJ1104-7EA42-0AA0	13740.-
		50	3VJ1105-7DA22-0AA0	7205.-	3VJ1105-7DA32-0AA0	10415.-	3VJ1105-7EA42-0AA0	13740.-
		63	3VJ1106-7DA22-0AA0	7205.-	3VJ1106-7DA32-0AA0	10415.-	3VJ1106-7EA42-0AA0	13740.-
		80	3VJ1108-7DA22-0AA0	7205.-	3VJ1108-7DA32-0AA0	10415.-	3VJ1108-7EA42-0AA0	13740.-
		100	3VJ1110-7DA22-0AA0	7205.-	3VJ1110-7DA32-0AA0	10415.-	3VJ1110-7EA42-0AA0	13740.-
		125	3VJ1112-7DA22-0AA0	7205.-	3VJ1112-7DA32-0AA0	11460.-	3VJ1112-7EA42-0AA0	15110.-
3VJ12 (VJ1 250)	55kA	160	3VJ1216-7DA22-0AA0	10330.-	3VJ1216-7DA32-0AA0	14505.-	3VJ1216-7EA42-0AA0	19160.-
		200	3VJ1220-7DA22-0AA0	10535.-	3VJ1220-7DA32-0AA0	16680.-	3VJ1220-7EA42-0AA0	22030.-
		250	3VJ1225-7DA22-0AA0	11535.-	3VJ1225-7DA32-0AA0	19180.-	3VJ1225-7EA42-0AA0	25335.-
3VJ13 (VJ1 400)	55kA	320	-	-	3VJ1332-7DA32-0AA0	24895.-	3VJ1332-7EA42-0AA0	32015.-
		400	-	-	3VJ1340-7DA32-0AA0	24895.-	3VJ1340-7EA42-0AA0	32015.-

Notes:

Phase barriers are included in the standard MCCB packing

^2P in 3P Frame Size

Std. Pkg. = 1 unit

* MRP - Max. Retail Price



3VJ10 MCCB, Thermal Magnetic Trip Unit, Adjustable Thermal Fixed Magnetic (ATFM), 415VAC, 50Hz NEW

Frame Size	Breaking Capacity @415V AC, 50/60Hz	Rated Current In (A)	3 Pole Type	Unit MRP* ₹	4 Pole Type	Unit MRP* ₹
3VJ10 (VJ1 125X)	10kA	20	3VJ1002-0DB32-0AA0	4160.-	3VJ1002-0EB42-0AA0	5620.-
		25	3VJ1092-0DB32-0AA0	4160.-	3VJ1092-0EB42-0AA0	5620.-
		32	3VJ1003-0DB32-0AA0	4160.-	3VJ1003-0EB42-0AA0	5620.-
		40	3VJ1004-0DB32-0AA0	4160.-	3VJ1004-0EB42-0AA0	5620.-
		50	3VJ1005-0DB32-0AA0	4160.-	3VJ1005-0EB42-0AA0	5620.-
		63	3VJ1006-0DB32-0AA0	4160.-	3VJ1006-0EB42-0AA0	5620.-
		80	3VJ1008-0DB32-0AA0	4160.-	3VJ1008-0EB42-0AA0	5620.-
		100	3VJ1010-0DB32-0AA0	4160.-	3VJ1010-0EB42-0AA0	5620.-
		125	3VJ1012-0DB32-0AA0	5985.-	3VJ1012-0EB42-0AA0	8445.-
	18kA	20	3VJ1002-1DB32-0AA0	6285.-	3VJ1002-1EB42-0AA0	8070.-
		25	3VJ1092-1DB32-0AA0	6285.-	3VJ1092-1EB42-0AA0	8070.-
		32	3VJ1003-1DB32-0AA0	6285.-	3VJ1003-1EB42-0AA0	8070.-
		40	3VJ1004-1DB32-0AA0	6285.-	3VJ1004-1EB42-0AA0	8070.-
		50	3VJ1005-1DB32-0AA0	6285.-	3VJ1005-1EB42-0AA0	8070.-
		63	3VJ1006-1DB32-0AA0	6285.-	3VJ1006-1EB42-0AA0	8070.-
		80	3VJ1008-1DB32-0AA0	6285.-	3VJ1008-1EB42-0AA0	8070.-
		100	3VJ1010-1DB32-0AA0	6285.-	3VJ1010-1EB42-0AA0	8070.-
		125	3VJ1012-1DB32-0AA0	7210.-	3VJ1012-1EB42-0AA0	9380.-
	25kA	20	3VJ1002-3DB32-0AA0	7225.-	3VJ1002-3EB42-0AA0	9575.-
		25	3VJ1092-3DB32-0AA0	7225.-	3VJ1092-3EB42-0AA0	9575.-
		32	3VJ1003-3DB32-0AA0	7225.-	3VJ1003-3EB42-0AA0	9575.-
		40	3VJ1004-3DB32-0AA0	7225.-	3VJ1004-3EB42-0AA0	9575.-
		50	3VJ1005-3DB32-0AA0	7225.-	3VJ1005-3EB42-0AA0	9575.-
		63	3VJ1006-3DB32-0AA0	7225.-	3VJ1006-3EB42-0AA0	9575.-
		80	3VJ1008-3DB32-0AA0	7225.-	3VJ1008-3EB42-0AA0	9575.-
		100	3VJ1010-3DB32-0AA0	7225.-	3VJ1010-3EB42-0AA0	9575.-
		125	3VJ1012-3DB32-0AA0	8245.-	3VJ1012-3EB42-0AA0	10530.-

Notes:
 Phase barriers are included in the standard MCCB packing
 Std. Pkg. = 1 unit * MRP - Max. Retail Price

Circuit Breakers



3VJ MCCB, Thermal Magnetic Trip Unit, Adjustable Thermal Fixed Magnetic (ATFM), 415VAC, 50Hz

NEW

Frame Size	Breaking Capacity @415V AC, 50/60Hz	Rated Current In (A)	3 Pole Type	Unit MRP* ₹	4 Pole Type	Unit MRP* ₹
3VJ12 (VJ1 250)	25kA	160	3VJ1216-3DB32-0AA0	11585.-	3VJ1216-3EB42-0AA0	14095.-
		200	3VJ1220-3DB32-0AA0	12505.-	3VJ1220-3EB42-0AA0	15745.-
		250	3VJ1225-3DB32-0AA0	14080.-	3VJ1225-3EB42-0AA0	18535.-
3VJ13 (VJ1 400)		320	3VJ1332-3DB32-0AA0	26340.-	3VJ1332-3EB42-0AA0	33925.-
		400	3VJ1340-3DB32-0AA0	26340.-	3VJ1340-3EB42-0AA0	33925.-
		3VJ11 (VJ1 125)	25	3VJ1192-5DB32-0AA0	9575.-	3VJ1192-5EB42-0AA0
32	3VJ1103-5DB32-0AA0		9575.-	3VJ1103-5EB42-0AA0	12650.-	
40	3VJ1104-5DB32-0AA0		9575.-	3VJ1104-5EB42-0AA0	12650.-	
50	3VJ1105-5DB32-0AA0		9575.-	3VJ1105-5EB42-0AA0	12650.-	
63	3VJ1106-5DB32-0AA0		9575.-	3VJ1106-5EB42-0AA0	12650.-	
80	3VJ1108-5DB32-0AA0		9575.-	3VJ1108-5EB42-0AA0	12650.-	
100	3VJ1110-5DB32-0AA0		9575.-	3VJ1110-5EB42-0AA0	12650.-	
125	3VJ1112-5DB32-0AA0		10845.-	3VJ1112-5EB42-0AA0	13755.-	
3VJ12 (VJ1 250)	160		3VJ1216-5DB32-0AA0	13140.-	3VJ1216-5EB42-0AA0	15975.-
	200	3VJ1220-5DB32-0AA0	17010.-	3VJ1220-5EB42-0AA0	21950.-	
	250	3VJ1225-5DB32-0AA0	19555.-	3VJ1225-5EB42-0AA0	25160.-	
3VJ13 (VJ1 400)	320	3VJ1332-5DB32-0AA0	27000.-	3VJ1332-5EB42-0AA0	34580.-	
	400	3VJ1340-5DB32-0AA0	27000.-	3VJ1340-5EB42-0AA0	34580.-	
3VJ11 (VJ1 125)	55kA	25	3VJ1192-7DB32-0AA0	11570.-	3VJ1192-7EB42-0AA0	15260.-
		32	3VJ1103-7DB32-0AA0	11570.-	3VJ1103-7EB42-0AA0	15260.-
		40	3VJ1104-7DB32-0AA0	11570.-	3VJ1104-7EB42-0AA0	15260.-
		50	3VJ1105-7DB32-0AA0	11570.-	3VJ1105-7EB42-0AA0	15260.-
		63	3VJ1106-7DB32-0AA0	11570.-	3VJ1106-7EB42-0AA0	15260.-
		80	3VJ1108-7DB32-0AA0	11570.-	3VJ1108-7EB42-0AA0	15260.-
		100	3VJ1110-7DB32-0AA0	11570.-	3VJ1110-7EB42-0AA0	15260.-
		125	3VJ1112-7DB32-0AA0	12735.-	3VJ1112-7EB42-0AA0	16790.-
3VJ12 (VJ1 250)		160	3VJ1216-7DB32-0AA0	15235.-	3VJ1216-7EB42-0AA0	20120.-
	200	3VJ1220-7DB32-0AA0	17520.-	3VJ1220-7EB42-0AA0	23135.-	
	250	3VJ1225-7DB32-0AA0	20140.-	3VJ1225-7EB42-0AA0	26605.-	
3VJ13 (VJ1 400)	320	3VJ1332-7DB32-0AA0	27660.-	3VJ1332-7EB42-0AA0	35570.-	
	400	3VJ1340-7DB32-0AA0	27660.-	3VJ1340-7EB42-0AA0	35570.-	

Notes: Phase barriers are included in the standard MCCB packing

Earth Fault Protection for 3VJ MCCBs

Description	Type	Unit LP* ₹	
Earth fault monitoring relay • Auxiliary voltage: 85-270V AC/DC • Change over contact: 2C/O • Width: 35mm module	7UG08611BU20	5120.-	
CBCT for EFR: Suitable for 3VJ10 up to 125A	3P	7UG09910	1765.-
	4P	7UG09911	2015.-
CBCT for EFR: Suitable for 3VJ11 up to 125A	3P	7UG09911	2135.-
	4P	7UG09911	2515.-
CBCT for EFR: Suitable for 3VJ12 up to 250A	3P	7UG09912	3145.-
	4P	7UG09913	3400.-

Earth Leakage Protection for 3VJ MCCBs

Description	Type	Unit LP* ₹	
Earth leakage relay 1Ph-2W, 3Ph-3W, 3Ph-4W	110VAC	7UG08411CB20	4950.-
	230VAC	7UG08421CD20	5000.-
CBCT for ELR	35 mm dia	7UG0996	1790.-
	70 mm dia	7UG0997	2040.-
	120 mm dia	7UG0999	3440.-
	210 mm dia	7UG0994	6440.-
	310 mm dia	7UG0995	9595.-

Note: Order 1 no of shunt trip for MCCB separately along with earth fault relay / earth leakage relay

Std. Pkg. = 1 unit

* MRP - Max. Retail Price

LP = List Price

3VJ Internal accessories

NEW

Frame Size	Accessory compartment/ Coil voltage	3VJ10 (VJ1 125X)	Unit MRP* ₹	3VJ11 (VJ1 125)	Unit MRP* ₹	3VJ12 (VJ1 250)	Unit MRP* ₹	3VJ13 (VJ1 400)	Unit MRP* ₹
Auxiliary Switches (AUX)	Left	3VJ9018-0AN11	1460.-	3VJ9218-0AN11	1510.-	3VJ9218-0AN11	1510.-	3VJ9417-0AN11	1565.-
	Right	-	-	3VJ9218-0AN21	1510.-	3VJ9218-0AN21	1510.-	3VJ9417-0AN21	1565.-
Alarm Switches (AL)	Left	3VJ9018-0AA11	1460.-	3VJ9118-0AA11	1460.-	3VJ9218-0AA11	1510.-	3VJ9417-0AA11	1565.-
	Right	-	-	3VJ9118-0AA21	1460.-	3VJ9218-0AA21	1510.-	3VJ9417-0AA21	1565.-
Auxiliary + Alarm Switches (AUX+AL)	Left	3VJ9018-0AD11	2375.-	3VJ9118-0AD11	2375.-	3VJ9218-0AD11	2485.-	3VJ9417-0AD11	2700.-
	Right	-	-	3VJ9118-0AD21	2375.-	3VJ9218-0AD21	2485.-	3VJ9417-0AD21	2700.-
Shunt Trip (Right) (ST)	24V DC	-	-	3VJ9218-0ST11	3025.-	3VJ9218-0ST11	3025.-	-	-
	24V AC/DC	-	-	-	-	-	-	3VJ9417-0ST21	3240.-
	48V DC	-	-	3VJ9218-0ST12	3025.-	3VJ9218-0ST12	3025.-	-	-
	48V AC/DC	-	-	-	-	-	-	3VJ9417-0ST22	3240.-
	110V DC	3VJ9018-0ST15#	Price on request	3VJ9218-0ST15	3025.-	3VJ9218-0ST15	3025.-	-	-
	110V AC/DC	-	-	-	-	-	-	3VJ9417-0ST25	3240.-
	110V AC	3VJ9018-0ST35#	Price on request	3VJ9218-0ST35	3130.-	3VJ9218-0ST35	3130.-	-	-
	220V AC	3VJ9018-0ST36#	Price on request	3VJ9218-0ST36	3240.-	3VJ9218-0ST36	3240.-	3VJ9417-0ST36	3565.-
415V AC	3VJ9018-0ST37#	Price on request	3VJ9218-0ST37	3240.-	3VJ9218-0ST37	3240.-	3VJ9417-0ST37	3565.-	
Undervoltage Release (Left) (UVR)	24V DC	-	-	3VJ9218-0UV11	4320.-	3VJ9218-0UV11	4320.-	-	-
	48V DC	-	-	3VJ9218-0UV12	4320.-	3VJ9218-0UV12	4320.-	-	-
	220V AC	-	-	3VJ9218-0UV36	4535.-	3VJ9218-0UV36	4535.-	3VJ9417-0UV36	10800.-
	415V AC	-	-	3VJ9218-0UV37	4860.-	3VJ9218-0UV37	4860.-	3VJ9417-0UV37	10800.-

Kindly contact nearest Sales Office for further information
Internal accessories are available for 2P, 3P & 4P 3VJ MCCBs

3VJ External accessories

NEW

Frame Size	No. of poles	3VJ10 (VJ1 125X)	Unit MRP* ₹	3VJ11 (VJ1 125)	Unit MRP* ₹	3VJ12 (VJ1 250)	Unit MRP* ₹	3VJ13 (VJ1 400)	Unit MRP* ₹
Extended Door Mounted Rotary Operator (including 8UC handle)@	-	3VJ9018-0HD11	2190.-	3VJ9118-0HD11	2355.-	3VJ9218-0HD11	2755.-	3VJ9417-0HD11	3480.-
Spreader Links^	2P	3VJ9012-0ED00	195.-	3VJ9112-0ED00	215.-	3VJ9212-0ED00	650.-	-	-
	3P	3VJ9013-0ED00	325.-	3VJ9113-0ED00	345.-	3VJ9213-0ED00	1055.-	3VJ9313-0ED00	1835.-
	4P	3VJ9014-0ED00	425.-	3VJ9114-0ED00	445.-	3VJ9214-0ED00	1370.-	3VJ9314-0ED00	2590.-
Phase Barriers#		3VJ9018-0CA00	150.-	3VJ9218-0CA00	240.-	3VJ9218-0CA00	240.-	3VJ9417-0CA00	260.-
Front Barriers\$	2P/3P	3VJ9016-0CJ30	350.-	3VJ9116-0CJ30	415.-	3VJ9216-0CJ30	595.-	3VJ9413-0CJ30	745.-
	4P	3VJ9014-0CJ40	490.-	3VJ9114-0CJ40	525.-	3VJ9214-0CJ40	695.-	3VJ9414-0CJ40	915.-
Toggle handle extension	-	-	-	-	-	-	-	3VJ9417-0DH10	590.-
Interlocking (for MCCBs with 8UC handles) - Castell interlock kit	-	8UC60701YQ..	4990.-	8UC60701YQ..	4990.-	8UC60701YQ..	4990.-	8UC60702YQ..	5125.-

Notes:

@ 1 set contains rotary mechanism, coupler, shaft & 8UC handle.

^ Spreader link 1 set = 2 nos. links in case of 2 pole; 3 nos. links in case of 3 pole; 4 nos. links in case of 4 pole.

Available as a spare; 1 set contains 2 phase barriers

\$ 1 set contains 2 front barriers (top & bottom)

Toggle handle extension is included in the standard packing of 3VJ13 (VJ1 400) MCCB.

Std. Pkg. = 1 unit

* MRP - Max. Retail Price



SENTRON 3WT^{Plus} Air Circuit Breakers

Unlock the future!!

- **Integrated communication and metering option**
- **Easy parameterization and diagnostics with Powerconfig**
- Wide range with 630A - 4000A current ratings
- 3P & 4P, Fixed & Withdrawable versions
- Available for operating voltages up to 690V AC
- Superior thermal ratings (no derating till 50°C)

www.siemens.co.in

SIEMENS

ACB: 3WT^{Plus}



- Conforms to IEC 60947-2
- Rated current - 630A to 4000A
- $U_{imp} = 12kV$
- **Integrated communication & metering option**
- **Easy parameterization and diagnostics with Powerconfig**
- Mechanical contact erosion indicator
- Fully rated upto 50°C
- Integrated LCD display and Online test facility
- Variants available for 690V AC applications

Standard breaking capacity, 500VAC $I_{cs} = 100\% I_{cu}$

Microprocessor based trip unit ETU37WT: LSING + Display

Frame Size	Rated current In (A)		Withdrawable design with Guide Frame ²⁾				
			3 Pole	Unit LP* ₹	4 Pole	Unit LP* ₹	
I	630	MDO	3WT8061-6AA04-5AB2	242560.-	3WT8065-6AA04-5AB2	315330.-	
		EDO	3WT8061-6UA34-5AB2	313745.-	3WT8065-6UA34-5AB2	386515.-	
	800	MDO	3WT8081-6AA04-5AB2	255985.-	3WT8085-6AA04-5AB2	335105.-	
		EDO	3WT8081-6UA34-5AB2	327170.-	3WT8085-6UA34-5AB2	406290.-	
	1000	MDO	3WT8101-6AA04-5AB2	262935.-	3WT8105-6AA04-5AB2	341065.-	
		EDO	3WT8101-6UA34-5AB2	334120.-	3WT8105-6UA34-5AB2	412250.-	
	1250	MDO	3WT8121-6AA04-5AB2	322965.-	3WT8125-6AA04-5AB2	383940.-	
		EDO	3WT8121-6UA34-5AB2	394150.-	3WT8125-6UA34-5AB2	455125.-	
	● 1600	MDO	3WT8161-6AA04-5AB2	346625.-	3WT8165-6AA04-5AB2	419605.-	
		EDO	3WT8161-6UA34-5AB2	417810.-	3WT8165-6UA34-5AB2	490790.-	
	II	● 2000	MDO	3WT8202-6AA04-5AB2	435510.-	3WT8206-6AA04-5AB2	536010.-
			EDO	3WT8202-6UA34-5AB2	506695.-	3WT8206-6UA34-5AB2	607195.-
● 2500		MDO	3WT8252-6AA04-5AB2	493310.-	3WT8256-6AA04-5AB2	627165.-	
		EDO	3WT8252-6UA34-5AB2	564495.-	3WT8256-6UA34-5AB2	698350.-	
● 3200		MDO	3WT8322-6AA04-5AB2	632445.-	3WT8326-6AA04-5AB2	776020.-	
		EDO	3WT8322-6UA34-5AB2	703630.-	3WT8326-6UA34-5AB2	847205.-	

Microprocessor based Trip Units

ETU35WT: LSI + Display



Reduce

1615.-



Reduce

1615.-

Microprocessor based trip unit ETU37WT: LSING + Display

Frame Size	Rated current In (A)		Fixed Mounted design ³⁾				
			3 Pole	Unit LP* ₹	4 Pole	Unit LP* ₹	
I	630	MF	3WT8061-6AA00-0AA2	178245.-	3WT8065-6AA00-0AA2	241155.-	
		EF	3WT8061-6UA30-0AA2	249430.-	3WT8065-6UA30-0AA2	312340.-	
	800	MF	3WT8081-6AA00-0AA2	192405.-	3WT8085-6AA00-0AA2	264735.-	
		EF	3WT8081-6UA30-0AA2	263590.-	3WT8085-6UA30-0AA2	335920.-	
	1000	MF	3WT8101-6AA00-0AA2	196135.-	3WT8105-6AA00-0AA2	280450.-	
		EF	3WT8101-6UA30-0AA2	267320.-	3WT8105-6UA30-0AA2	351635.-	
	1250	MF	3WT8121-6AA00-0AA2	266785.-	3WT8125-6AA00-0AA2	315480.-	
		EF	3WT8121-6UA30-0AA2	337970.-	3WT8125-6UA30-0AA2	386665.-	
	● 1600	MF	3WT8161-6AA00-0AA2	272405.-	3WT8165-6AA00-0AA2	337930.-	
		EF	3WT8161-6UA30-0AA2	343590.-	3WT8165-6UA30-0AA2	409115.-	
	II	● 2000	MF	3WT8202-6AA00-0AA2	306355.-	3WT8206-6AA00-0AA2	439775.-
			EF	3WT8202-6UA30-0AA2	377540.-	3WT8206-6UA30-0AA2	510960.-
● 2500		MF	3WT8252-6AA00-0AA2	345805.-	3WT8256-6AA00-0AA2	516335.-	
		EF	3WT8252-6UA30-0AA2	416990.-	3WT8256-6UA30-0AA2	587520.-	
● 3200		MF	3WT8322-6AA00-0AA2	526515.-	3WT8326-6AA00-0AA2	648430.-	
		EF	3WT8322-6UA30-0AA2	597700.-	3WT8326-6UA30-0AA2	719615.-	

Microprocessor based Trip Units

ETU35WT: LSI + Display



Reduce

1615.-



Reduce

1615.-

For Non-Automatic ACBs please deduct ₹ 3670/- from the LPs of the ACBs marked ●. For type nos. of Non-Automatic ACBs contact nearest sales office

L: Overload protection S: Delayed Short Circuit protection

I: Short circuit protection

G: Ground fault protection¹⁾

N: Neutral protection¹⁾

Standard accessories included for electrical ACB (EDO/EF) = Motor operated mechanism, with mechanical and electrical closing, motor and closing solenoid of 220-240V AC/DC and shunt release of 220-240V AC/DC.

¹⁾ Current transformer for N-conductor shall be ordered separately for 3P ACB with Earth Fault and Neutral Conductor Protection.

²⁾ Standard Accessories included for draw out type ACB (EDO/MDO) = Safety shutter, sealing cap over Off button, door sealing frame, trip unit transparent cover, trip signaling contact, ready to close signaling contact, auxiliary contacts 2NO+ 2NC

³⁾ Standard accessories included for fixed type ACB (EF/MF) = Door sealing frame, trip unit transparent cover, trip signaling contact, ready to close signaling contact, auxiliary contacts 2NO+2NC

Note: Please contact nearest sales office for information on prices of 4000A ACB.

Additional LP for 690V AC ACB - ₹ 32240/-

For information on 3WT^{Plus} Air Circuit Breakers please contact your nearest Siemens sales office

Std. Pkg. = 1 unit

* LP - List Price

3WT^{Plus} Accessories

Description	AC 50/60Hz V	DC V	Type	Unit LP* ₹
Motorized Operating Mechanism with Electrical closing	110-127	110-125	3WT9831-1JH00	76385.-
	220-240	220-250	3WT9831-1JK00	76385.-
Shunt Release or Closing Coil Suitable for continuous operation	–	24	3WT9851-1JB00	6540.-
	110-127	110-125	3WT9851-1JH00	6540.-
Under Voltage Release Instantaneous	220-240	220-250	3WT9851-1JK00	6540.-
	110-127	110-125	3WT9853-1JH00	6800.-
	208-240	220-250	3WT9853-1JK00	6800.-
Auxiliary Terminal Block	380-415	–	3WT9853-1JM00	6800.-
	Fixed circuit breaker		3WT9825-1JC00	4775.-
	Drawout circuit breaker		3WT9827-1JA00	4775.-
Auxiliary Switch Block	2 Change over		3WT9816-1CE00	3005.-
Position Signal Switch for Withdrawable Breaker	3NO+3NC, 2NO+2NC, 1NO+1NC		3WT9884-1JC10	14785.-
5 digit operating cycle counter			3WT9864-OCA00	12345.-
Blocking Device for preventing opening of cubicle door in service position: for Withdrawable Breaker			3WT9867-1JC00	11475.-
Blocking Device for preventing opening of cubicle door in ON position: for Fixed Breaker			3WT9867-2JA00	11475.-
Castell Lock Mounting Kit (to prevent unauthorized closing of the circuit breaker)			3WT9863-6JE00	9740.-
Castell Lock			3WX3663-6JEL_#	4520.-
Door Sealing Frame (Also suitable for 3WL ACB)			3WX3686-OJA00	2875.-
External Current Sensor for N-conductor (For 3P ACB with Neutral or E/F Protection)	Size I		3WL9111-0AA21-0AA0	23495.-
	Size II		3WL9111-0AA22-0AA0	28570.-
External Current Sensor for N-conductor with copper connectors (for 3P ACB with Neutral or E/F protection)	Size I		3WL9111-0AA31-0AA0	25785.-
	Size II		3WL9111-0AA32-0AA0	29595.-

Types of castell locks shall be of type A, B, C, D, AB, AC; _ to be replaced by the type no.

For fitment of motor/ shunt/ closing coil/ UV release/ addl. auxiliary contacts please order necessary Auxiliary terminal blocks as per circuit diagram.

Add-on options (Factory fitted)

Description	Unit LP* ₹
MODBUS RTU communication module	Price on request
Metering function with integrated Voltage tap	
Arc chute cover	
Phase barriers	

Retrofit solution

Description	Unit LP* ₹
Ready to fit kit for upgrading from our old or other make conventional Air Circuit Breaker to modern SENTRON range of ACBs. <ul style="list-style-type: none"> • Minimum Shut Down Time • No change in the existing panel except door cut out • No change in the existing panel bus-bars • Proven Siemens Design • No over heating • Cost Effective & Quality Solution 	Upon enquiry

For more details write to us at: ics.india@siemens.com • Toll Free No: 1800220987/18002090987

Std. Pkg. = 1 unit

* LP - List Price

ACB: SENTRON 3WL *Plus*

- Conforms to IEC 60947-2
- Rated current - 630A to 6300A
- Accurate protection through microprocessor based trip unit
- Unique ready-to-close interlock for maximum safety
- Mechanical contact erosion indicator
- Fully rated upto 55°C
- Neutral 100% rated
- Integrated online test facility
- Unique CubicleBus technology
- Data communication and power management options



Standard breaking capacity $I_{cs} = 100\% I_{cu}$

Manually operated ACB

Microprocessor based trip unit ETU45B LSIN protection (Overload and short circuit protection)

Frame Size	Rated Current In (A)	Type	Withdrawable design with Guide Frame		Fixed mounted design	
			Unit LP* ₹	Unit LP* ₹	Unit LP* ₹	Unit LP* ₹
			3 Pole	4 Pole	3 Pole	4 Pole
I	630	3WL1106....	331200.-	418380.-	218555.-	327850.-
	800	3WL1108....	334825.-	426600.-	225280.-	336210.-
	1000	3WL1110....	343660.-	456115.-	247235.-	355070.-
	1250	3WL1112....	416065.-	526205.-	304115.-	433420.-
	1600	3WL1116....	458745.-	578035.-	321865.-	466885.-
II	2000	3WL1220....	507695.-	643050.-	359355.-	514540.-
	2500	3WL1225....	570815.-	747745.-	365370.-	560350.-
	3200	3WL1232....	739480.-	1015590.-	505505.-	850890.-
	4000	3WL1240....	850635.-	1080165.-	688140.-	932555.-
III	5000	3WL1350....	1405250.-	1782925.-	1254470.-	1646695.-
	6300	3WL1363....	1889215.-	2374030.-	1637700.-	2159490.-

Prices of ACBs with other breaking capacities available on request.

L: Overload protection S: Delayed Short Circuit protection I: Short circuit protection
G: Ground fault protection N: Neutral protection

Note: Std. Pkg. = 1 unit

Add-on options (Factory fitted)

Microprocessor based Release	Add LP* ₹
For ground fault protection	24585.-
Protection function LSIN with Current display	11755.-
Protection function LSING with Current display	35250.-

For prices of breakers with other types of microprocessor based trip unit, please consult your nearest sales office

Motorised Mechanism	Add LP* ₹
208-240VAC, 220Vdc motor, closing coil & Shunt trip coil	90335.-
110-127VAC, 110Vdc motor, closing coil & Shunt trip coil	90335.-

Motorized mechanism with other control voltages are available on request

All ACBs are with Top Horizontal - Bottom Horizontal main terminals except 6300A & 4000A which have only Vertical-Vertical main termination.

Standard Accessories included for draw out type ACB (EDO/MDO) = Safety shutter, door sealing frame, ready to close signal switch, auxiliary contacts 2NO+ 2NC and trip unit transparent cover & trip signal switch (Not applicable for ACBs without trip unit).

Standard accessories included for fixed type ACB (EF/IF) = Door sealing frame, ready to close signal switch, auxiliary contacts 2NO+2NC and trip unit transparent cover & trip signal switch (Not applicable for ACBs without trip unit)

Neutral CT if required, shall be ordered separately. *Castell locks are to be ordered separately.

Please consult your nearest sales office for complete ordering code.

Add-on options (Factory fitted)

Description	Add LP* ₹
Spring Charge Signal Switch	7790.-
Door Interlock	6600.-
Position Signal Switch for Withdrawable Breaker	17085.-
Castell lock mounting kit*	5565.-
Mutual Mechanical Interlocking (Bowden wire)	Price on request
Metering function Plus (voltage transformer must be ordered separately)	
Profibus communication connection (COM15 + BSS)	
Modbus communication connection (COM16 + BSS)	
Modbus TCP/PROFINET communication connection (COM35 + BSS) NEW	

ACB for 1000/1150 V AC operation and DC application available on request

Accessories

Description	AC 50/60Hz V	DC V	Type	Unit LP* ₹
Shunt Release or Closing Coil Suitable for continuous operation	-	24	3WA9111-0AD02	15100.-
	110	110	3WA9111-0AD05	15100.-
	230	220	3WA9111-0AD06	15100.-
Under Voltage Release (Instantaneous)	380-415	-	3WA9111-0AE07	16690.-
Motorised Operating Mechanism	-	24-30	3WA9111-0AF02	83475.-
	110-127	110-125	3WA9111-0AF05	83475.-
	208-240	220-250	3WA9111-0AF06	83475.-
Auxiliary Switch Block	2NO+2NC		3WL9111-0AG01-0AA0	10040.-
Castell Lock	-	-	3WX3663-6JEL_ \$	4520.-

Please order necessary auxiliary terminal blocks as per circuit diagram while ordering accessories. Please consult your nearest sales office for type nos. and prices.

\$ Types of castell locks shall be of type A, B, C, D, AB, AC; _ to be replaced by the type no.

Std. Pkg. = 1 unit

* LP - List Price



SIMARIS software tools

SIMARIS suite: Easy access to SIMARIS planning tools

Integrated and Safe planning of complete power
distribution system

SIMARIS design

Power distribution network planning

- From medium-voltage in-feed down to final distribution
- Based on calculations as per IS/ IEC standards
- With automatic selection of appropriate switchgear & components

SIMARIS curves

Visualization & evaluation of:

- Tripping characteristics
- Cut-off current characteristics
- Let-through energy curves

*Download FREE version from www.siemens.com/simaris

www.siemens.com/simaris



SIMARIS Suite



SIMARIS design 10.0



SIMARIS curves 6.2



SIMARIS project 6.3



SIMARIS Online
Toolbox

SIEMENS



NEW

SENTRON

Transfer control devices

3KC ATC6300 & 6500

- Suitable for Utility to DG, Utility to Utility and DG to DG changeover in combination with motorized breakers
- Automatic Load management and control of tie breaker (with ATC 6500 only)
- Communication capable via expansion modules on Modbus TCP or MODBUS RTU
- Confirms to IEC 60947-6-1
- Plug-in DI/DO expansion modules for additional functionality
- Easy parameterization through Powerconfig
- Ingress protection up to IP65

www.siemens.com/switching-devices

SIEMENS

SENTRON Auto transfer controllers

In accordance with IEC 60947-6-1, IEC standard for transfer switching equipments



	3KC ATC 3100	3KC ATC 6300	3KC ATC 6500
Display	-	Yes, LCD	Yes, LCD
Network	3 Phase Only	Single Phase / 2 Phase or 3 Phase systems (Including 3 Phase – 4 Wire systems)	Single Phase / 2 Phase or 3 Phase systems (Including 3 Phase – 4 Wire systems)
Maximum rated voltage U _e	400V AC	100-480V AC L-L	100-600V AC L-L
Application type	Utility – Utility Utility - DG	Utility – Utility Utility - DG DG - DG	Utility – Utility Utility - DG DG - DG
Number of controllable breakers	2	2	3
Automatic load management (load shedding)	No	No	Yes
Parameterization	Pushbuttons & Rotary Switches	LCD Display USB Front interface ¹⁾ Communication Modules ²⁾	LCD Display USB Front interface ¹⁾ Communication Modules ²⁾
Expansion Modules	No	Yes, DI/DOs Communication Modules	Yes, DI/DOs Communication Modules
Communication Option	No	Yes, MODBUS RTU/ MODBUS TCP via expansion modules	Yes, Integrated RS485 Port (MODBUS RTU) MODBUS TCP via expansion module

^{1) 2)} Available as accessory. Parameterization to be done via Powerconfig

Description	Type No	Unit LP* ₹	Std. pkg. (nos.)
Automatic Transfer Controllers			
3KC ATC 3100 ⁵	3KC9000-8EL10	67285.-	1
3KC ATC 6300	3KC9000-8TL40	97265.-	1
3KC ATC 6500	3KC9000-8TL50	Price on request	1
Accessories Expandable DI /DO Modules (For both ATC 6300 & 6500)			
ATC6 expansion module 4DI	3KC9000-8TL60	Price on request	1
ATC6 expansion module 4DO, SSR	3KC9000-8TL61	Price on request	1
ATC6 expansion module 2DI/2DO, SSR	3KC9000-8TL62	Price on request	1
ATC6 expansion module 2DO, relay	3KC9000-8TL63	Price on request	1
ATC6 expansion module 2DI/2DO, relay	3KC9000-8TL64	Price on request	1
Expansion modules with communication interfaces (For both ATC 6300 & 6500)			
ATC6 RS 485 expansion module	3KC9000-8TL74	Price on request	1
ATC6 Ethernet expansion module	3KC9000-8TL75	Price on request	1
USB Front interface (For both ATC 6300 & 6500)			
ATC6 USB front interface	3KC9000-8TL73	Price on request	1
IP 65 Protective Gasket			
For ATC 6300 144 x 144 mm	3KC9000-8TL67	Price on request	1
For ATC 6300 171 x 131 mm	3KC9000-8TL68	Price on request	1
Other Accessories			
Connection cable 3KC ATC3100 to MCCBs / ACBs	3KC9000-8EL62	13605.-	1

⁵ It is advisable to use connection cable with 3KC ATC3100

* LP - List Price

**Complete Auto
changeover
solution with
SIEMENS circuit
breakers**

Designed and tested with





SIVACON

Technology
Partner

SIEMENS

When it comes to safety, nothing beats SIVACON

**SIVACON S8 - the only most economical switchboard
with true closed door trolley disconnection**

The SIVACON S8 low-voltage power distribution switchboard sets new standards of fail-proof safety & service. In conformance to the IEC 61439-1&2, SIVACON S8 guarantees high performance, maximum safety and compact modularity.

Features

- The only 'Arc Free' switchboards in the world
- SIVACON patented double front PCCs upto 7000A, 150kA
- Patented holeless technology for connections
- Patented ventilation technique
- Combination of fixed, plugin & drawout feeders in the same vertical
- State-of-the-art technology, innovation in design and unmatched performance

www.siemens.com/sivacon-details

SIEMENS



Power monitoring made simple

Measuring devices and software from the
SENTRON portfolio

- Ease of operation and visualization
- Scalability
- Cyber Security
- Various communication protocols

www.siemens.com/powermonitoring

SIEMENS

Energy Management System

(A) Hardware Solutions

Complete Range of Power Monitoring Devices for LV and HV Networks



Description	Type	Unit LP* ₹
SMART 7KT Multifunction Meter	7KT0310	15065.-

Description	Type	Unit LP* ₹
PAC 3120 with integrated RS 485 port for MODBUS RTU Class 0.5 accuracy, screw terminals AC/DC wide voltage power supply 100 ... 250 V ±10% 50/60Hz	7KM3120-0BA01-1DA0#	44090.-
PAC 3220 with integrated dual ethernet port for MODBUS TCP Class 0.5 accuracy, screw terminals With AC/DC wide voltage power supply 100 ... 250 V ±10% 50/60Hz	7KM3220-0BA01-1DA0#	60235.-
PAC 4200 with integrated ethernet port for MODBUS TCP Class 0.2s accuracy, screw terminals With AC/DC wide voltage power supply 95...240V AC ±10%, 50/60Hz, 110...340V DC ±10%	7KM4212-0BA00-3AA0#	Price on request

Expansion Modules (for PAC3220 and PAC4200)

Description	Type	Unit LP* ₹
PROFIBUS DP expansion module	7KM9300-0AB01-0AA0	21505.-
RS485 expansion module for MODBUS RTU	7KM9300-0AM00-0AA0	16605.-
Switched Ethernet PROFINET V3 expansion module	7KM9300-0AE02-0AA0	Price on request
Digital Expansion Module 4DI/2DO ⁵	7KM9200-0AB00-0AA0	Price on request
Analog Expansion Module	7KM9200-0AD00-0AA0	Price on request

For extra low DC voltage (22 ... 65 V DC ± 10 %) option, please contact your nearest Siemens partner.

⁵ Maximum 2 nos.can be connected if communication expansion module is not connected.

For exact configuration, please contact the nearest Sales Office.

(B) Software Solution

Description	Unit LP* ₹
SENTRON powermanager 3.6: Complete Energy Management Software	Price on request

Std. Pkg. = 1 unit

* LP - List Price

SMART 7KT: Smart metering solutions for load feeders

- Integrated communication facility (MODBUS RTU)
- Inbuilt DI
- Ingress protection upto IP65

PAC 3120: Cost Effective Solution for digital measurement

- Display of instantaneous, maximum and minimum values
- Measurement of Active & Reactive Power (Import / Export / Net)
- CT polarity reversal correction from the device

PAC 3220: Specialist solution for precise energy data capture

- Dual Metering function
- Dual ethernet interface for MODBUS TCP communication
- Optional communication over PROFIBUS DP and PROFINET

PAC 4200: Professional solution for communication and monitoring

- Integrated gateway functionality for MODBUS RTU devices
- Reliable event recording with battery backup
- Sliding window for maximum demand

PAC EXPANSION Modules



7KM PAC 3220



7KM PAC 4200



MODBUS RTU



PROFINET



PROFIBUS DP



I(N), I(Diff), Analog



PAC 4DI/2DO



Single Platform Energy Management Solution for LV power distribution

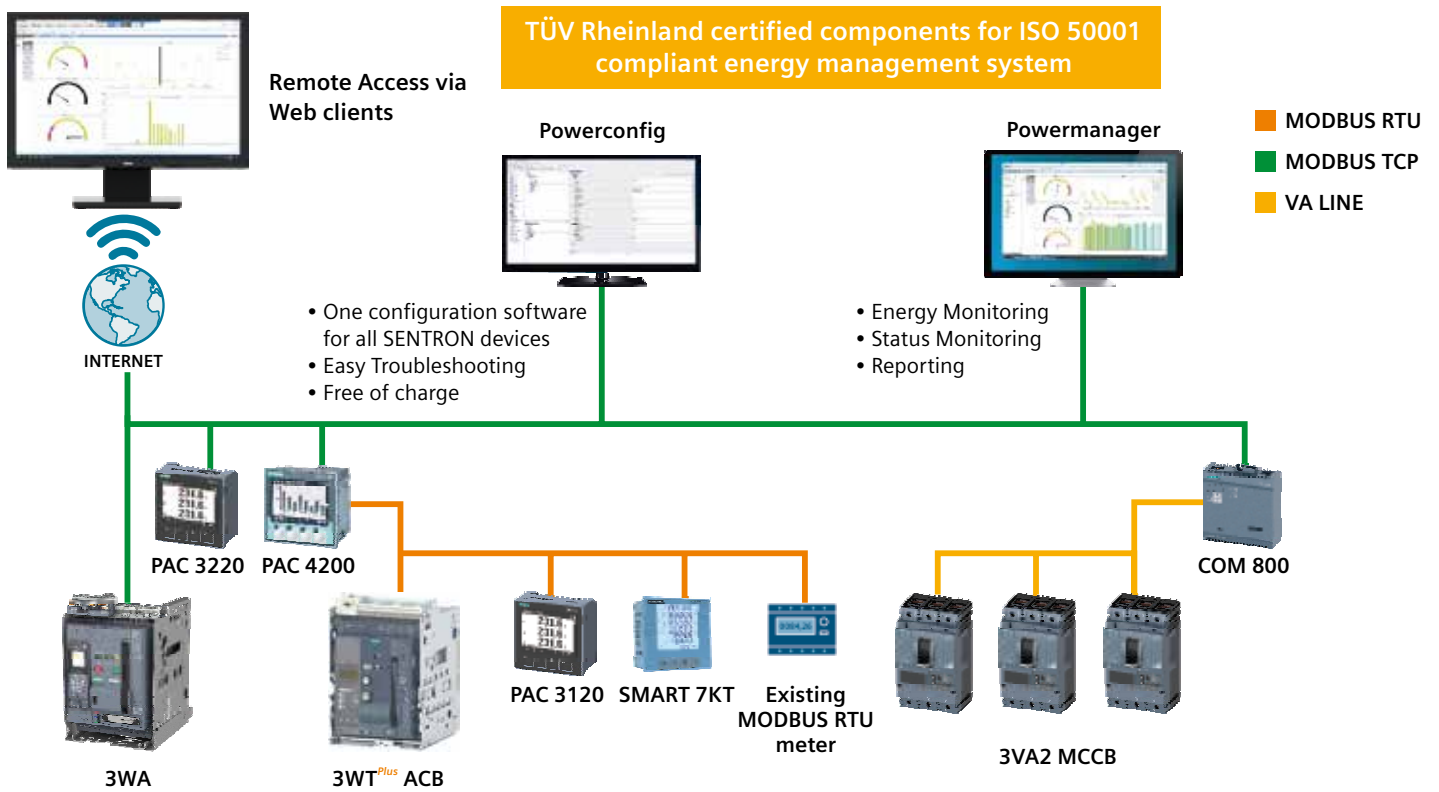

Energy Management System



Power Quality Measurement

SENTRON 7KM PAC 5100/5200

- Measured value capture in accordance with power quality standard IEC 61000-4-30
- Recording of power quality anomalies like sag, swell and interruption
- Integrated web server to set parameters and display measured values on HTML pages

For more details, contact your nearest Siemens partner.

www.siemens.co.in

DIN Rail Mounted Meters for energy monitoring in Infra and Building Applications

Description	Type	Unit LP* ₹
PAC 2200 DIN rail meter with integrated RS 485 port for MODBUS RTU 65A direct connection Class 1 accuracy	7KM2200-2EA40-1DA1	29425.-
PAC 2200 DIN rail meter with integrated ethernet port for MODBUS TCP 65A direct connection Class 1 accuracy	7KM2200-2EA40-1EA1	Price on request
PAC3200T DIN rail meter with integrated ethernet port for MODBUS TCP High accuracy of class 0.5 Without display	7KM3200-0CA01-1AA0	Price on request

Std. Pkg. = 1 unit

* LP - List Price

PAC 2200 and PAC 3200T:

Reliable and Easy energy monitoring for DIN rail Applications

- Compact design on standard mounting rail
- Integrated digital input (DI) and Digital output (DO)
- Integrated web server
- Neutral conductor current display
- THD Measurement



SETRON 7KT PAC 1600 DIN Rail mounted compact Energy Meters

- PAC 1600 range of single phase and three phase meters
- Space saving mounting by very slim construction
- Energy counters for active, reactive and apparent energy
- THD: Up to 15th harmonics

www.siemens.com/powermonitoring



SENTRON

Fuse Switch Disconnectors - **3NP1**

End to end safety for user and systems

- Compliant with IEC 60947-1 and IEC 60947-3
- 1-pole to 4-pole versions up to 630A at 1000V AC/ DC
- Fuse and Voltage monitoring
- 40/ 60mm busbar mounting option
- Selection chart with SITOR fuses

www.siemens.com/switching-devices

SIEMENS

SETRON 3NP1 Fuse Switch Disconnectors up to 630A

Reliable safety of personnel and systems

Overview:

- Available in five frame sizes from 100 to 630 A
- Optional for use of fuse links in LV HRC design
- 1-, 2-, 3- and 4-pole switchable

Application:

- Can be used in main and auxiliary circuits
- For non-routine switching
- VFD/ Soft Starter/ Capacitor panels

Benefits:

- Fuse puller is not required
- Mounting flexibility: Base / DIN / busbar
- AC20 / DC20 1000V

3NP1 with Floor mounting

3NP1 without fuse monitoring

Rated current (A)	3NP1 size	DIN fuse size	Terminals type	Poles ⁴⁾	Type	Unit LP* ₹
100 ¹⁾	000	000	Box	1	3NP1121-1CA20	3575.-
				3	3NP1123-1CA20	6500.-
				4	3NP1124-1CA20	11345.-
160 ²⁾	00	000,00	Flat	1	3NP1131-1CA10	3765.-
				3	3NP1133-1CA10	6795.-
				4	3NP1134-1CA10	11825.-
250 ²⁾	1	00,1	Flat	1	3NP1141-1DA10	10965.-
				3	3NP1143-1DA10	19885.-
				4	3NP1144-1DA10	32610.-
400 ²⁾	2	1,2	Flat	1	3NP1151-1DA10	15085.-
				3	3NP1153-1DA10	27255.-
				4	3NP1154-1DA10	44110.-
630 ²⁾	3	2,3	Flat	1	3NP1161-1DA10	20075.-
				3	3NP1163-1DA10	36520.-
				4	3NP1164-1DA10	58520.-



1-pole



3-pole



2-pole



4-pole

3NP1 with Electronic fuse monitoring ³⁾

Rated current (A)	3NP1 size	DIN fuse size	Terminals type	Poles ⁴⁾	Type	Unit LP* ₹
100 ¹⁾	000	000	Box	1	3NP1121-1CA24	12530.-
				3	3NP1123-1CA24	19395.-
160 ²⁾	00	000,00	Flat	1	3NP1131-1CA14	12700.-
				3	3NP1133-1CA14	19570.-
250 ²⁾	1	00,1	Flat	1	3NP1141-1DA14	19910.-
				3	3NP1143-1DA14	32610.-
400 ²⁾	2	1,2	Flat	1	3NP1151-1DA14	24200.-
				3	3NP1153-1DA14	40330.-
630 ²⁾	3	2,3	Flat	1	3NP1161-1DA14	29180.-
				3	3NP1163-1DA14	49260.-



1-pole with EFM



3-pole with EFM

- 1) Can be used up to 160A along with an accessory feeder terminal 3NP1923-1BD00 (for 3-pole) and 3NP1921-1BD00 (for 1-pole)
- 2) Box type terminals available for higher ratings 3NP1.
- 3) EFM voltage range: 1-pole: 24 ... 240 V AC (phase to N) / 24 ... 250 V DC (L+ to L-); 3-pole: 190 ... 690 V AC (phase to phase) .

Further voltage ranges are available as accessories. EFM needs external 24V DC power supply.

- 4) 2-pole 3NP1 is a combination of 2 nos. 1-pole 3NP1 with assembly kit accessories. Please refer page 39 for assembly kit selection.

Configurator for 3NP1

- Ready-to-install version
- Application specific switches
- Accessories



Load Break Switches

3NP1 mounting on 8US busbar

3NP1 mounting on 60mm 8US busbar system ³⁾

3NP1 without fuse monitoring

Rated current (A)	3NP1 size	DIN fuse size	Terminals type	Poles ⁴⁾	Type	Unit LP* ₹
100 ¹⁾	000	000	Box	3	3NP1123-1BC20	9620.-
				4	3NP1124-1BC20	16025.-
160 ²⁾	00	00	Flat	3	3NP1133-1BC10	10325.-
				4	3NP1134-1BC10	17270.-
250 ²⁾	1	1	Flat	3	3NP1143-1BC10	32920.-
				4	3NP1144-1BC10	51310.-
400 ²⁾	2	2	Flat	3	3NP1153-1BC10	42545.-
				4	3NP1154-1BC10	66760.-
630 ²⁾	3	3	Flat	3	3NP1163-1BC10	54000.-
				4	3NP1164-1BC10	85660.-

8US busbar system

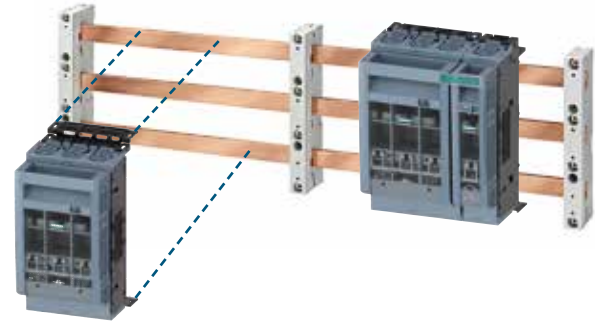

Accessories for 3NP1

Auxillary contact (1CO type)



3NP1 Size	Type	Unit LP* ₹
000	3NP1920-1FA00	1495.-
00	3NP1930-1FA00	1495.-
1,2,3	3NP1940-1FA00	1625.-

Feeder terminals for 3NP1 121/ 3 for use up to 160A



3NP1 Size	Terminals type	Poles	Type	Unit LP* ₹
000	Box	1	3NP1921-1BD00	1885.-
		3	3NP1923-1BD00	4215.-

Assembly kit for connection of 1-pole and 3-pole 3NP1 to form floor mounted 2-pole⁴⁾ and 4-pole 3NP1



3NP1 Size	Type	Unit LP* ₹
000	3NP19211EC00	Price on request
00	3NP19311EC00	
1,2,3	3NP19411EC00	

Assembly kit for mounting 3NP1 floor type on 8US 60mm busbar system ⁵⁾



3NP1 Size	Terminals type	Poles	Type	Unit LP* ₹
000	Box	1	3NP1921-1EE10	Price on request
00			3NP1931-1EE10	

- 1) Can be used up to 160A along with an accessory feeder terminal 3NP1923-1BD00 (for 3-pole) and 3NP1921-1BD00 (for 1-pole)
- 2) Box type terminals available for higher ratings 3NP1.
- 3) 3NP1 also available for Rittal RiLine 60 busbar system with base
- 4) 2-pole 3NP1 is a combination of 2 nos. 1-pole 3NP1 with assembly kit accessories.
- 5) Contains all parts for assembly and connection.

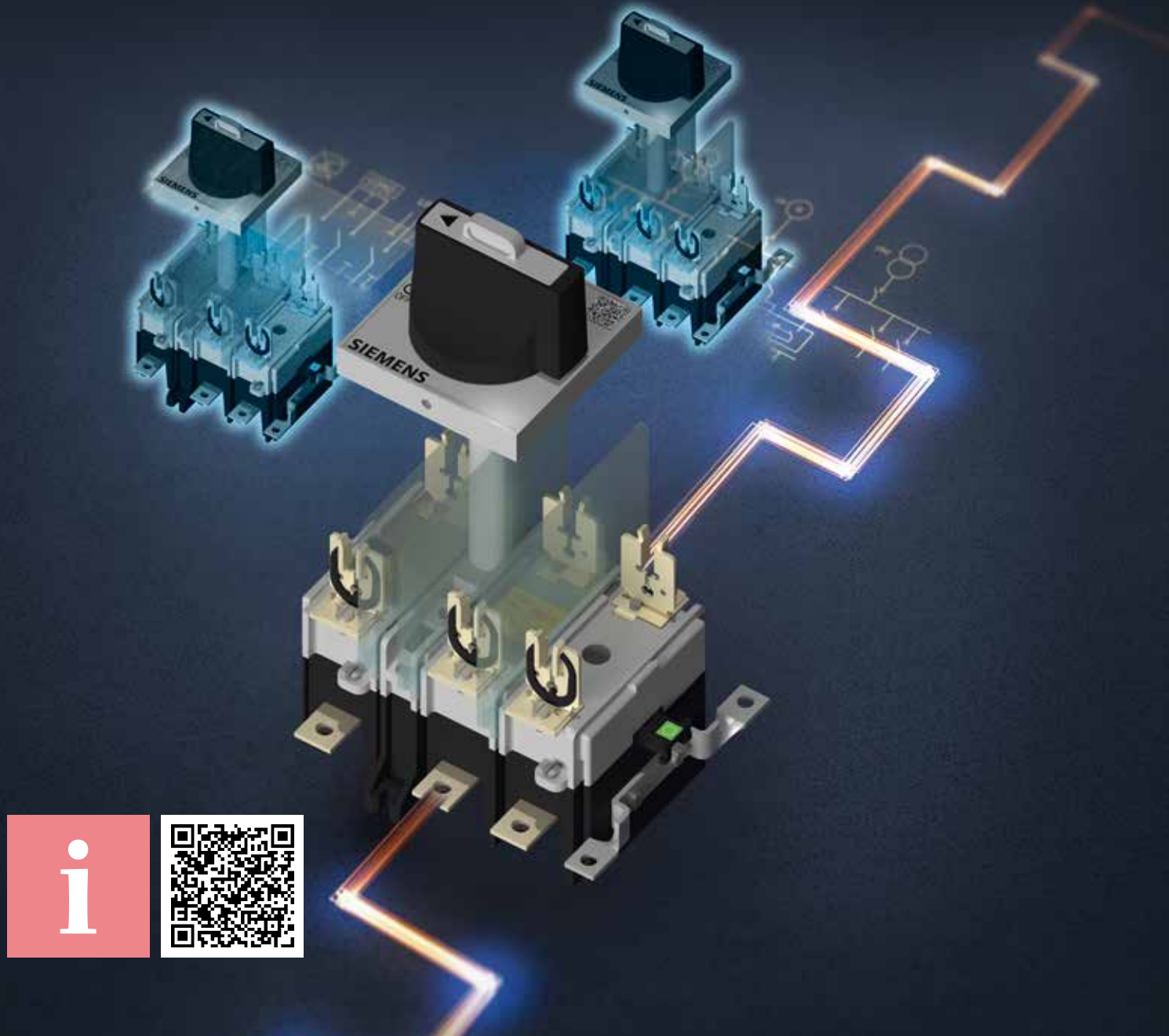

SUPERSWITCH

Switch Disconnecter Fuse - **3KL8**

Safe. Reliable. Efficient.

- Compliant with IS/ IEC 60947-3
- 2-pole to 4-pole versions up to 800A at 690V AC
- COMPACT 2-pole and TRUE 4-pole versions
- DIN/ BS/ Cylindrical fuse type versions
- With Enclosure option
- AC-23A for the complete range
- Type 2 co-ordination chart for DOL and Star Delta feeders

www.siemens.co.in/superswitch3k

SIEMENS

Superswitch 3KL8

- Wide range : Up to 800A in SDF and 1600A in SD
- Available in 2P,3P,3PN & 4P variants
- Suitable for isolation as per IS/IEC 60947-3
- Unique positive off indication
- Suitable for AC23A Duty @ 690V AC, 50Hz
- Roller contacts with high operating life
- IP65 handle with door interlock
- Wide range of accessories
- Suitable for power distribution as well as motor protection

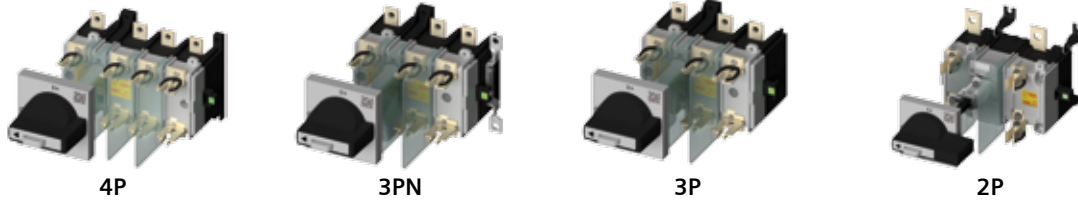

Switch disconnecter fuse: 3KL8 4-pole, for power distribution (in Open Execution)

Rated current I _e @690V 50Hz	SDF suitable for DIN type HRC fuses	Unit MRP* ₹	SDF suitable for BS type HRC fuses	Unit MRP* ₹	SDF suitable for Cylindrical type HRC fuses	Unit MRP* ₹	Std. pkg. (nos.)
20A	3KL8111-4TA00	2770.-	3KL8111-4TJ00	2820.-	3KL8111-4TC00	2880.-	1
32A	3KL8121-4TA00	2870.-	3KL8121-4TJ00	3090.-	3KL8121-4TC00	3110.-	1
63A	3KL8151-4TA00	3860.-	3KL8151-4TJ00	3915.-	3KL8151-4TC00	4080.-	1
100A	3KL8171-4TA00	5795.-	-	-	-	-	1
100A	3KL8211-4TA00	8325.-	3KL8211-4TJ00	9085.-	-	-	1
125A	3KL8221-4TA00	10210.-	3KL8221-4TJ00	10815.-	-	-	1
160A	3KL8231-4TA00	11330.-	3KL8231-4TJ00	13140.-	-	-	1
200A	3KL8311-4UA00	16255.-	3KL8311-4UJ00	17065.-	-	-	1
250A	3KL8321-4UA00	18940.-	3KL8321-4UJ00	20225.-	-	-	1
315A	3KL8331-4UA00	22800.-	3KL8331-4UJ00	24955.-	-	-	1
400A	3KL8341-4UA00	25090.-	3KL8341-4UJ00	28830.-	-	-	1
500A	3KL8411-4UA00	40740.-	3KL8411-4UJ00	46470.-	-	-	1
630A	3KL8421-4UA00	42235.-	3KL8421-4UJ00	48155.-	-	-	1
800A [§]	3KL8431-4UA00	49925.-	3KL8431-4UJ00	52170.-	-	-	1

Switch disconnecter fuse:3KL8 3PN for power distribution and motor protection (Open Execution)

Rated current I _e @690V 50Hz	SDF suitable for DIN type HRC fuses	Unit MRP* ₹	SDF suitable for BS type HRC fuses	Unit MRP* ₹	SDF suitable for Cylindrical type HRC fuses	Unit MRP* ₹	Std. pkg. (nos.)
20A	3KL8111-5TA00	2660.-	3KL8111-5TJ00	2670.-	3KL8111-5TC00	2680.-	1
32A	3KL8121-5TA00	2710.-	3KL8121-5TJ00	2725.-	3KL8121-5TC00	2745.-	1
63A	3KL8151-5TA00	3635.-	3KL8151-5TJ00	3705.-	3KL8151-5TC00	3745.-	1
100A	3KL8171-5TA00	5150.-	-	-	-	-	1
100A	3KL8211-5TA00	7245.-	3KL8211-5TJ00	7310.-	-	-	1
125A	3KL8221-5TA00	8980.-	3KL8221-5TJ00	9105.-	-	-	1
160A	3KL8231-5TA00	9885.-	3KL8231-5TJ00	10030.-	-	-	1
200A	3KL8311-5UA00	13565.-	3KL8311-5UJ00	13975.-	-	-	1
250A	3KL8321-5UA00	15410.-	3KL8321-5UJ00	15835.-	-	-	1
315A	3KL8331-5UA00	18355.-	3KL8331-5UJ00	18655.-	-	-	1
400A	3KL8341-5UA00	21910.-	3KL8341-5UJ00	22445.-	-	-	1
500A	3KL8411-5UA00	35570.-	3KL8411-5UJ00	36385.-	-	-	1
630A	3KL8421-5UA00	38555.-	3KL8421-5UJ00	39410.-	-	-	1
800A [§]	3KL8431-5UA00	39950.-	3KL8431-5UJ00	42705.-	-	-	1

Switch disconnecter fuse: 3KL8 3-pole, for motor protection (in Open Execution)

Rated current I _e @ 690V 50Hz	SDF suitable for DIN type HRC Fuses	Unit MRP* ₹	Std. pkg. (nos.)
20A	3KL8111-1TA00	2580.-	1
32A	3KL8121-1TA00	2640.-	1
63A	3KL8151-1TA00	3570.-	1
100A	3KL8211-1TA00	7115.-	1
125A	3KL8221-1TA00	8835.-	1
160A	3KL8231-1TA00	9780.-	1
200A	3KL8311-1UA00	13145.-	1
250A	3KL8321-1UA00	15325.-	1
315A	3KL8331-1UA00	18075.-	1
400A	3KL8341-1UA00	21765.-	1
500A	3KL8411-1UA00	35025.-	1
630A	3KL8421-1UA00	38310.-	1
800A [§]	3KL8431-1UA00	39705.-	1

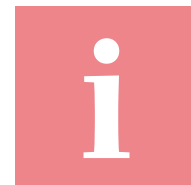

§ 3KL8431 (800A): 710A with fuse cover

Notes:

2P = 2-pole; 3P = 3-pole; 3PN = 3-pole with neutral link; 4P = 4-pole

3KL8: Unit MRPs are without fuses

3KL8: Unit MRPs are inclusive of Front drive (Handle) and phase barriers

Please scan the QR code for brochure and Operation manual (OM)

Refer the OM for changes in dimension

Std. Pkg. = 1 unit

* MRP - Maximum Retail Price

Superswitch 3KL8

Switch disconnecter fuse: 3KL8 2-pole (Open Execution)

Rated current I _e @690V 50Hz	SDF suitable for DIN type HRC fuses	Unit MRP* ₹	SDF suitable for BS type HRC fuses	Unit MRP* ₹	SDF suitable for Cylindrical type HRC fuses	Unit MRP* ₹	Std. pkg. (nos.)
20A [®]	3KL8111-2TA00	2460.-	-	-	3KL8111-2TC00	2500.-	1
32A [®]	3KL8121-2TA00	2500.-	-	-	3KL8121-2TC00	2615.-	1
63A [®]	3KL8151-2TA00	3255.-	-	-	3KL8151-2TC00	3285.-	1
100A [®]	3KL8171-2TA00	4895.-	-	-	-	-	1
100A	3KL8211-2TA00	6935.-	3KL8211-2TJ00	7090.-	-	-	1
125A	3KL8221-2TA00	8040.-	3KL8221-2TJ00	8755.-	-	-	1
160A	3KL8231-2TA00	8360.-	3KL8231-2TJ00	9425.-	-	-	1
200A	3KL8311-2UA00	12150.-	3KL8311-2UJ00	12905.-	-	-	1
250A	3KL8321-2UA00	13235.-	3KL8321-2UJ00	14250.-	-	-	1
315A	3KL8331-2UA00	16095.-	3KL8331-2UJ00	16600.-	-	-	1
400A	3KL8341-2UA00	19190.-	3KL8341-2UJ00	19600.-	-	-	1
500A	3KL8411-2UA00	29435.-	3KL8411-2UJ00	34270.-	-	-	1
630A	3KL8421-2UA00	30985.-	3KL8421-2UJ00	34775.-	-	-	1
800A [§]	3KL8431-2UA00	39165.-	3KL8431-2UJ00	39290.-	-	-	1

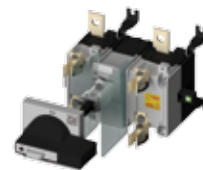

Switch disconnecter fuse in SS[^] Enclosure (factory fitted)¹⁾

Rated current I _e @690V 50Hz	Suitable fuse type	3PN	Unit MRP* ₹	4P	Unit MRP* ₹	Std. pkg. (nos.)
20A	DIN	3KL8111-5TA10	5570.-	3KL8111-4TA10	5935.-	1
	BS	3KL8111-5TJ10	5615.-	3KL8111-4TJ10	5950.-	1
	CYL	3KL8111-5TC10	5650.-	3KL8111-4TC10	5995.-	1
32A	DIN	3KL8121-5TA10	5955.-	3KL8121-4TA10	6120.-	1
	BS	3KL8121-5TJ10	5975.-	3KL8121-4TJ10	6190.-	1
	CYL	3KL8121-5TC10	6005.-	3KL8121-4TC10	6215.-	1
63A	DIN	3KL8151-5TA10	6620.-	3KL8151-4TA10	7220.-	1
	BS	3KL8151-5TJ10	6640.-	3KL8151-4TJ10	7400.-	1
	CYL	3KL8151-5TC10	6695.-	3KL8151-4TC10	7425.-	1
100A	DIN	3KL8211-5TA10	10605.-	3KL8211-4TA10	11630.-	1
	BS	3KL8211-5TJ10	10915.-	3KL8211-4TJ10	11740.-	1
125A	DIN	3KL8221-5TA10	12575.-	3KL8221-4TA10	14005.-	1
	BS	3KL8221-5TJ10	12665.-	3KL8221-4TJ10	14440.-	1
160A	DIN	3KL8231-5TA10	13490.-	3KL8231-4TA10	15395.-	1
	BS	3KL8231-5TJ10	13595.-	3KL8231-4TJ10	15495.-	1
200A	DIN	3KL8311-5UA10	19270.-	3KL8311-4UA10	25130.-	1
	BS	3KL8311-5UJ10	19415.-	3KL8311-4UJ10	25705.-	1
250A	DIN	3KL8321-5UA10	21845.-	3KL8321-4UA10	26760.-	1
	BS	3KL8321-5UJ10	21995.-	3KL8321-4UJ10	26945.-	1
315A	DIN	3KL8331-5UA10	25985.-	3KL8331-4UA10	31845.-	1
	BS	3KL8331-5UJ10	26130.-	3KL8331-4UJ10	32010.-	1
400A	DIN	3KL8341-5UA10	29975.-	3KL8341-4UA10	35710.-	1
	BS	3KL8341-5UJ10	30360.-	3KL8341-4UJ10	35865.-	1
500A	DIN	3KL8411-5UA10	44630.-	3KL8411-4UA10	52520.-	1
	BS	3KL8411-5UJ10	44770.-	3KL8411-4UJ10	53090.-	1
630A	DIN	3KL8421-5UA10	46985.-	3KL8421-4UA10	55770.-	1
	BS	3KL8421-5UJ10	47125.-	3KL8421-4UJ10	55940.-	1
800A [§]	DIN	3KL8431-5UA10	50445.-	3KL8431-4UA10	59880.-	1
	BS	3KL8431-5UJ10	50575.-	3KL8431-4UJ10	60035.-	1



SS[^] Enclosure for 3KL8/ 3KA8

Rated current I _e @690V 50Hz	Enclosure type	Unit MRP* ₹	Std. pkg. (nos.)
20A 160A	3KX8235-4AC	3495.-	1
200A-400A	3KX8345-4AC	4650.-	1
500A-800A	3KX8435-4AC ¹⁾	7625.-	1
200A-800A	3KX8435-4AG #2) NEW	13100.-	1

@ In 3P housing

^ SS stands for Sheet Steel

1) 3KL8 in SS Enclosure: Includes 3KL8 SDF without fuses, SS Enclosure, front drive (Handle) and phase barriers

\$ 3KL8431 (800A): 710A with fuse cover

^ SS stands for Sheet Steel

Enclosure for 4-pole SDF / SD type 3KL83/4 & 3KA83/4

1) SD (except 4-pole) type 3KA84 (630A-1600A), recommended to be used along with gland box 3KX84354DC (2nos.)

2) SD (4-pole only) type 3KA84 (630A-1600A), recommended to be used along with gland box 3KX84354DG (2nos.)

Std. Pkg. = 1 unit * MRP - Maximum Retail Price

Notes:

2P = 2-pole; 3P = 3-pole; 3PN = 3-pole with neutral link; 4P = 4-pole

3KL8: Unit MRPs are without fuses

3KL8: Unit MRPs are inclusive of Front drive (Handle) and phase barriers

Refer the brochure for fuse selection guide

Refer the OM for changes in dimension

Superswitch 3KA8

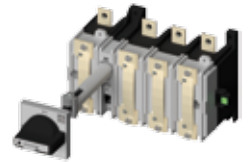

Switch Disconnector: 3KA8 for power distribution (in Open Execution)

Rated current I _n @690V 50Hz	2P	Unit MRP* ₹	3PN	Unit MRP* ₹	4P	Unit MRP* ₹	Std. pkg. (nos.)
63A	3KA8151-2TE00 [®]	2755.-	3KA8151-5TE00	3255.-	3KA8151-4TE00	4285.-	1
100A	-	-	3KA8171-5TE00	5025.-	3KA8171-4TE00	8625.-	1
100A	3KA8211-2TE00	4825.-	3KA8211-5TE00	6450.-	3KA8211-4TE00	9970.-	1
125A	3KA8221-2TE00	6060.-	3KA8221-5TE00	7405.-	3KA8221-4TE00	10710.-	1
160A	3KA8231-2TE00	8070.-	3KA8231-5TE00	9640.-	3KA8231-4TE00	13495.-	1
200A	3KA8311-2UE00	9970.-	3KA8311-5UE00	12325.-	3KA8311-4UE00	15660.-	1
250A	3KA8321-2UE00	10910.-	3KA8321-5UE00	13015.-	3KA8321-4UE00	19235.-	1
400A	3KA8341-2UE00	15135.-	3KA8341-5UE00	19245.-	3KA8341-4UE00	26220.-	1
630A [§]	3KA842□-2UE00	24280.-	3KA842□-5UE00	30545.-	3KA842□-4UE00	37535.-	1
800A [§]	3KA843□-2UE00	25335.-	3KA843□-5UE00	31530.-	3KA843□-4UE00	43070.-	1
1000A [§]	3KA844□-2UE00	33900.-	3KA844□-5UE00	45290.-	3KA844□-4UE00	53075.-	1
1250A [§]	3KA845□-2UE00	44575.-	3KA845□-5UE00	58750.-	3KA845□-4UE00	63805.-	1
1600A [§]	3KA846□-2UE00	51410.-	3KA846□-5UE00	65025.-	3KA846□-4UE00	85930.-	1

□ - 2: Top Incoming
□ - 3: Bottom Incoming

@ In 3P housing

§ Utilization category AC21A @690V AC (1600A: @500V AC)

Notes:

2P = 2-pole; 3P = 3-pole; 3PN = 3-pole with neutral link; 4P = 4-pole

3KL8: Unit MRPs are without fuses

3KL8: Unit MRPs are inclusive of Front drive (Handle) and phase barriers

Please scan the QR code for Catalog and Operating instruction sheets (OIS)

Refer the OIS for changes in dimension

Accessories for Superswitch 3KL8 / 3KA8

Description	Pole	Fuse type	3KL81 11/21/51/71 3KA81 51/71	Unit MRP* ₹	3KL82 11/21/31 3KA82 11/21/31	Unit MRP* ₹	3KL83 11/21/31/41 3KA83 11/21/41	Unit MRP* ₹	3KL84 11/21/31 3KA84 2/3/4/5/6	Unit MRP* ₹	Std. pkg. (nos.)				
Fuse cover ²⁾	2P	DIN	3KX8150-0AE ⁵⁾	230.-	3KX8230-0JF	560.-	3KX8340-0AF	815.-	3KX8430-0JF	1155.-	1				
		BS			3KX8230-0HF	560.-			3KX8430-0HF	1155.-	1				
	3P	DIN			3KX8230-0JE	560.-			3KX8340-0AE	815.-	3KX8430-0JE	1155.-	1		
		BS			3KX8230-0HE	560.-					3KX8430-0HE	1155.-	1		
	4P	DIN			3KX8230-0JG	560.-					3KX8340-0AG	815.-	3KX8430-0JG	1155.-	1
		BS			3KX8230-0HG	560.-							3KX8430-0HG	1155.-	1
Terminal cover (1set = 2pieces)	2P	-	3KX8151-0AE	110.-	3KX8231-0AF	470.-	3KX8341-0AF	895.-					3KX8431-0AF	1045.-	1
	3P	-			3KX8231-0AE	470.-							3KX8341-0AE	895.-	3KX8431-0AE
	4P	-			3KX8231-0AG	470.-			3KX8341-0AG	895.-			3KX8431-0AG	1045.-	1
Phase barrier	-	DIN/ BS/ Cylindrical	3KX8153-0AE	45.-	3KX8153-0AE (DIN)	45.-	3KX8343-0AE	145.-	3KX8433-0AE	215.-			1		
					3KX8233-0JE (BS)	45.-					1				
Fuse cover phase barrier kit ³⁾	-	-	-	-	-	3KX8340-9AE	455.-	3KX8440-9AE	455.-	1					
Auxiliary switch (1NO+1NC)	-	3SB5400-0A [^]	205.-	3KX3522-1YC	720.-	3KX3552-1YC	865.-	3KX3582-1YC	1045.-	1					
Auxiliary switch (2NO+2NC)	-	-	-	3KX3522-1YD	1295.-	3KX3552-1YD	1875.-	3KX3582-1YD	2025.-	1					
Auxiliary switch cover	-	3KX8154-0AC	80.-	3KX8234-0AC	80.-	-	-	-	-	1					
Front drive (Handle)	-	8UC6114-1BB00	955.-	8UC6214-1BB00	1080.-	8UC6314-1BB00	1635.-	8UC6414-1BB00	2385.-	1					
Operating shaft (300mm)	-	8UC60-31	265.-	8UC60-32	320.-	8UC60-34	620.-	8UC60-34	620.-	1					
Castell interlock ¹⁾ ^	-	8UC6070-0YQ..	4990.-	8UC6070-1YQ..	4990.-	8UC6070-2YQ..	5125.-	8UC6070-2YQ..	5125.-	1					
Key interlock	-	-	-	-	-	3KX3588-1YP(.) [#]	2345.-	3KX3588-1YP(.) [#]	2345.-	1					
Depth setting template	-	8UC6046-2	50.-	8UC6046-2	50.-	8UC6046-2	50.-	8UC6046-2	50.-	1					
Fuse Monitor with auxiliary switch [^] (1NO+1NC)	-	3RV1611-0BD10	8260.-	3RV1611-0BD10	8260.-	3RV1611-0BD10	8260.-	3RV1611-0BD10	8260.-	1					
	-	3RV2901-1E	995.-	3RV2901-1E	995.-	3RV2901-1E	995.-	3RV2901-1E	995.-	1					
Fuse safety barrier	-	3KX8150-1AC	120.-	3KX8230-1AC	160.-	-	-	-	-	1					
Gland box with gland plate (1no.)	-	3KX8235-4DC	4055.-	3KX8235-4DC	4055.-	3KX8345-4DC	5600.-	3KX8435-4DC	8525.-	1					
	-	-	-	-	-	-	-	3KX8435-4DG ⁴⁾	13950.-	1					
Gland plate	-	3KX8235-4GC	855.-	3KX8235-4GC	855.-	3KX8345-4GC	1115.-	3KX8435-4GC	1235.-	1					
	-	-	-	-	-	-	-	3KX8435-4GG ⁴⁾	1250.-	1					

Type of keys are Type A - F depending on the last digit (.) to be replaced by letters A - F.

1) The 11th and 12th place of the type reference will indicate the alphabet type of lock & key. Combinations available are A, B, C, D, A-, -B, -C, AB, AC. 11th place will be A, B, C, D for castell lock type A, B, C, D respectively. 11th and 12 place will be A0, 0B, 0C, AB, AC for castell lock type A-, -B, -C, AB, AC respectively.

2) Additionally order "Fuse cover phase barrier kit" with Fuse cover for 200A - 800A SDF

3) Mandatory accessory to be ordered with fuse cover for 200A - 800A SDF

4) Accessory for 4-pole SDF with enclosure type 3KL83 & 3KL84 and SS enclosure type 3KX8435-4AG

5) Also, suitable for SDF with cylindrical type HRC fuses

Note: The above accessories e.g. Fuse Cover, Terminal Cover, Phase barrier, Fuse cover phase barrier kit & Front Drive (handle) are unique (different) and not to be used along with MLFB 3KL8...-3.A00, 3KL8...-3.J00, 3KL8...-3.C00

Std. Pkg. = 1 unit * MRP - Maximum Retail Price ^ - List Price

Main control and EMERGENCY STOP switches 3LD2

- Rated current range: 16A-250A
- Conforms to IEC 60947-3 / UL508
- Can be used for motor & power distribution application



Main and EMERGENCY-STOP switches with rotary operating mechanism

Front mounting - Four hole mounting
Lockable in OFF position with upto 3 padlocks,
Degree of Protection IP65



No of Poles	Rated current (A) Ie AC21A	Motor KW AC 23A, 380....440V, 50/60Hz	Type	Unit LP* ₹
3	16	7.5	3LD2003-0TK5□	2795.-
	25	9.5	3LD2103-0TK5□	3090.-
	32	11.5	3LD2203-0TK5□	3445.-
	63	22	3LD2504-0TK5□	5900.-
	100	37	3LD2704-0TK5□	8945.-
	125	45	3LD2804-0TK5□	11395.-
	160	75	3LD2305-0TK1□	Price on request
	250	132	3LD2405-0TK1□	Price on request

□ - 1: Black OR
□ - 3: Red/yellow

Main control and EMERGENCY-STOP switches with selector switch operating mechanism

Front mounting - Four hole mounting
Lockable in OFF position with upto 2 padlocks,
Degree of Protection IP65,
Including terminal cover for incoming side



No of Poles	Rated current (A) Ie AC21A	Motor KW AC 23A, 380....440V, 50/60Hz	Type	Unit LP* ₹
3	16	7.5	3LD2022-0TK1□	2495.-
	25	9.5	3LD2122-0TK1□	2735.-
	32	11.5	3LD2222-0TK1□	3320.-

□ - 1: Black OR
□ - 3: Red/yellow

Changeover switches with selector switch operating mechanism

Front mounting - Four hole mounting
Selector switch cannot be locked
Degree of Protection IP65
Black Actuator



No of Poles	Rated current (A) Ie AC21A	Motor KW AC 23A, 380....440V, 50/60Hz	Type	Unit LP* ₹
3	25	9.5	3LD2123-7UK01	6120.-
	32	11.5	3LD2223-7UK01	6695.-
	63	22	3LD2524-7UK01	11075.-
	100	37	3LD2724-7UK01	20590.-
	160	75	3LD2305-7UK01	Price on request
	250	132	3LD2405-7UK01	Price on request

Changeover switch with knob Operated Mechanism In moulded plastic enclosure



No of Poles	Rated current (A) Ie AC21A	Motor KW AC 23A, 380....440V, 50/60Hz	Type	Unit LP* ₹
3	25	9.5	3LD21657UB01	9800.-
	32	11.5	3LD22657UB01	11140.-
	63	22	3LD25667UB01	24165.-
	100	37	3LD27667UB01	39775.-

Main and EMERGENCY-STOP switches with door coupling rotary operating mechanism

Panel mounting with 300mm switch shaft -
Four hole mounting
Lockable in OFF position with upto 3 padlocks,
Degree of Protection IP65
Including terminal cover for incoming side



No of Poles	Rated current (A) Ie AC21A	Motor KW AC 23A, 380....440V, 50/60Hz	Type	Unit LP* ₹
3	16	7.5	3LD2013-0TK5□	4475.-
	25	9.5	3LD2113-0TK5□	4970.-
	32	11.5	3LD2213-0TK5□	5480.-
	63	22	3LD2514-0TK5□	6570.-
	100	37	3LD2714-0TK5□	10795.-
	125	45	3LD2814-0TK5□	13480.-
	160	75	3LD2318-0TK1□	Price on request
	250	132	3LD2418-0TK1□	Price on request

□ - 1: Black OR
□ - 3: Red/yellow

Main control and EMERGENCY-STOP switches In Moulded plastic enclosures

Lockable in OFF position with upto 3 padlocks,
Degree of Protection IP65,
with centre hole mounting
with N and/or PE ground terminals



No of Poles	Rated current (A) Ie AC21A	Motor KW AC 23A, 380....440V, 50/60Hz	Type	Unit LP* ₹
3	16	7.5	3LD2064-0TB5□	3980.-
	25	9.5	3LD2164-0TB5□	4320.-
	32	11.5	3LD2264-0TB5□	5130.-
	63	22	3LD2565-0TB5□	8495.-
	100	37	3LD2766-0TB5□	19310.-
	125	45	3LD2866-0TB5□	34945.-

□ - 1: Black OR
□ - 3: Red/yellow

Note: 3LD23/24 knob operated mechanism

Std. Pkg. = 1 unit * LP - List Price

Configurator for 3LD

- Ready-to-install version
- Application specific switches
- Accessories



Accessories for 3LD2

Mounting	Description	For Switch	Type	Unit LP* ₹	Std. pkg. (nos.)		
For front mounting switch	Add on switched 4th pole (N Conductor Leading switch ON, delayed switch OFF)	3LD21 (25A) and 3LD22 (32A)	3LD92200B	1255.-	1		
		3LD25 (63A)	3LD92500BA	1845.-	1		
		3LD27 (100A) and 3LD28 (125A)	3LD92800B	2295.-	1		
		3LD23 (160A) and 3LD24 (250A)	3LD92400B	Price on request	1		
	N or PE terminal Continuous	3LD20 (16A)	3LD92002B	840.-	1		
		3LD21 (25A) and 3LD22 (32A)	3LD92202B	960.-	1		
		3LD25 (63A)	3LD92502BA	1260.-	1		
		3LD27 (100A) and 3LD28 (125A)	3LD92802B	1535.-	1		
	Auxiliary switches For mounting on left and/or right 1NO+1NC	3LD23 (160A) and 3LD24 (250A)	3LD92402B	Price on request	1		
		3LD20, 3LD21, 3LD22, 3LD25, 3LD27, 3LD28, 3LD23 and 3LD24	3LD92005B	1395.-	1		
		For floor and distribution board mounting switch or 3LD2 switch in moulded-plastic enclosure	Add on switched 4th pole (N Conductor Leading switch ON, delayed switch OFF)	3LD21 (25A) and 3LD22 (32A)	3LD92200C	1255.-	1
				3LD25 (63A)	3LD92500CA	1845.-	1
3LD27 (100A) and 3LD28 (125A)	3LD92800C			2295.-	1		
3LD23 (160A) and 3LD24 (250A)	3LD92400C			Price on request	1		
N or PE terminal Continuous	3LD20 (16A)		3LD92002C	1140.-	1		
	3LD21 (25A) and 3LD22 (32A)		3LD92202C	960.-	1		
	3LD25 (63A)		3LD92502CA	1260.-	1		
	3LD27 (100A) and 3LD28 (125A)		3LD92802C	1535.-	1		
Auxiliary switches For mounting on left and/or right 1NO+1NC	3LD23 (160A) and 3LD24 (250A)		3LD92402C	Price on request	1		
	3LD20, 3LD21, 3LD22, 3LD25, 3LD27, 3LD28, 3LD23 and 3LD24		3LD92005C	1325.-	1		
	Terminal cover for touch protection can be snapped on at top & bottom for front, floor and distribution board mounting		4 pole	3LD20 (16A)	3LD92011A	430.-	4
			3 pole	3LD21 (25A) and 3LD22 (32A)	3LD92210A	395.-	4
3 pole		3LD25 (63A)	3LD92510A	445.-	4		
1 pole		3LD27 (100A) and 3LD28 (125A)	3LD92812A	215.-	4		
1 pole		3LD23 (160A) and 3LD24 (250A)	3LD92412A	Price on request	4		
For front (four hole mounting only) and floor mounting switch or 3LD2 switch in moulded-plastic enclosure	Auxiliary switch, front-mounted, for long leading times 1NO+1NC, lagging switch-on, leading switch-off (20 ms to 150 ms)	3LD20, 3LD21, 3LD22, 3LD25, 3LD27 and 3LD28	3LD92805D	Price on request	1		
		3LD23 and 3LD24	3LD92405D	Price on request	1		

3LD2 maintenance and repair switches with EMC shield plate.
Please contact your nearest Siemens partner for further details.



Spares & accessories for motor control switches**

Motor control switches 3LA0

Description		Motor output 415V, 50Hz, 3Ph kW	Type	Unit LP* ₹	Std. pkg. (nos.)
Open execution	On/Off	7.5	3LA0201-1YA	2155.-	10
		30	3LA0601-1YB	5010.-	5
	System selector	5.5	3LA0202-1YA	2460.-	10
		30	3LA0602-1YB	7005.-	5
	Reversing	5.5	3LA0203-1YA	2460.-	10
		30	3LA0603-1YB	7005.-	5
	Star-delta	12	3LA0204-5YA	3470.-	10
		30	3LA0604-1YB	9535.-	5
	2 speed pole changing i) Separate windings ii) Dahlander	5.5	3LA0205-2YA	2460.-	10
		5.5	3LA0205-1YA	3315.-	10
5.5		3LA0205-3YA	4760.-	10	

Description	Type	Unit LP* ₹	Std. pkg. (nos.)
Ball handle – Black	3LX0 211-1YA	130.-	10
Machine handle – Black	3LX0 611-2YA	350.-	10
Indicating dial for size 2	3LX0 220-1YA	100.-	10
Indicating dial for size 6	3LX0 620-1YA	100.-	10
Catching lever for the drive mechanism of size 2switch (2 nos. reqd. per switch)	3LY0 220-2YA	100.-	10
Tension spring for the drive mechanism of size 2 switch	3LY0 210-1YA	90.-	10

** All parts supplied loose in polythene bags.

Heavy duty switches 3LA0

No. of poles	Rated current		Open execution		
	AC 22A	AC 23A	Type	Unit LP* ₹	Std. pkg. (nos.)
2	25	16	3LA0205-4YA	1480.-	10
	63	52	3LA0605-1YB	3550.-	5
4	25	16	3LA0205-5YA	2460.-	10
	63	52	3LA0605-2YB	6480.-	5

* LP - List Price



3LD4 Control Switches

- Compact and flexible design
- Double break contacts ensures high reliability
- Suitable for ambient temperatures up to 50°C
- Quick and easy installation
- High electrical and mechanical life

www.siemens.co.in

SIEMENS

3LD4 Control Switches

The 3LD4 Control Switches are cam operated switches suitable for use in a wide variety of control and auxiliary circuit applications.

- Conforms to IEC 60947-3, IEC 60947-5
- Range 6A to 100A
- Suitable for AC21A, AC-15 Utilization category
- Suitable for ambient up to 50°C
- Double break contacts for reliable operation
- Terminals designed for easy and fast installation



ON OFF Switches

90° operation

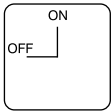

Type#	Description	Unit LP* ₹									Std. pkg. (nos.)
		6A (001)	10A (102)	16A (103)	20A (104)	25A (205)	32A (206)	40A (207)	63A (208)	100A (309)	
3LD4 ___ 1AA00-ORCO	1 Pole	155.-	290.-	345.-	365.-	375.-	470.-	595.-	695.-	3625.-	1
3LD4 ___ 2AA00-ORCO	2 Pole	195.-	330.-	390.-	435.-	455.-	540.-	710.-	885.-	4530.-	
3LD4 ___ 3AA00-ORCO	3 Pole	210.-	390.-	460.-	500.-	595.-	665.-	830.-	1195.-	5575.-	
3LD4 ___ 4AA00-ORCO NEW	4 Pole	260.-	425.-	490.-	600.-	730.-	785.-	950.-	1435.-	6530.-	

90° Operation with complete rotation

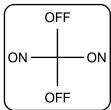

Type#	Description	Unit LP* ₹									Std. pkg. (nos.)
		6A (001)	10A (102)	16A (103)	20A (104)	25A (205)	32A (206)	40A (207)	63A (208)	100A (309)	
3LD4 ___ 1BC00-ORCO	1 Pole	150.-	290.-	345.-	365.-	370.-	460.-	590.-	690.-	3625.-	1
3LD4 ___ 2BC00-ORCO	2 Pole	195.-	330.-	390.-	435.-	455.-	540.-	710.-	885.-	4530.-	
3LD4 ___ 3BC00-ORCO	3 Pole	210.-	390.-	460.-	500.-	595.-	665.-	830.-	1195.-	5575.-	
3LD4 ___ 4BC00-ORCO NEW	4 Pole	260.-	425.-	490.-	600.-	730.-	785.-	950.-	1435.-	6530.-	

* Fill in the 3rd, 4th & 5th digit of the type nos with the digits in () to get complete MLFB e.g. for 6A 3 Pole ON OFF Switch the complete type no will be 3LD40013AA00-ORCO

Instrumentation Selector Switch

Ammeter Selector Switch (ASS)

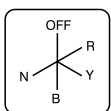
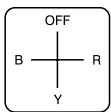

Description	Rating	Type#	Unit LP* ₹	Std. pkg. (nos.)
Line currents with OFF	6A	3LD40014DC200RCO	320.-	1
	10A	3LD41024DC200RCO	380.-	
	16A	3LD41034DC200RCO	485.-	
	20A	3LD41044DC200RCO	545.-	
Line currents with Neutral with OFF	6A	3LD40014DD200RCO	315.-	1
	10A	3LD41024DD200RCO	375.-	
	16A	3LD41034DD200RCO	475.-	
	20A	3LD41044DD200RCO	610.-	



* LP - List Price

3LD4 Control Switches

Voltmeter Selector Switch (VSS)

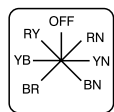
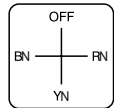
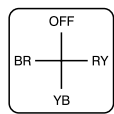

Description	Rating	Type#	Unit LP* ₹	Std. pkg. (nos.)
Line voltages with OFF	6A	3LD40014DC300RC0	230.-	1
	10A	3LD41024DC300RC0	345.-	
	16A	3LD41034DC300RC0	440.-	
	20A	3LD41044DC300RC0	500.-	
Phase voltages with OFF	6A	3LD40014DC310RC0	415.-	
	10A	3LD41024DC310RC0	470.-	
	16A	3LD41034DC310RC0	600.-	
	20A	3LD41044DC310RC0	660.-	
Line & Phase voltages with OFF	6A	3LD40014DF300RC0	415.-	
	10A	3LD41024DF300RC0	695.-	
	16A	3LD41034DF300RC0	825.-	
	20A	3LD41044DF300RC0	895.-	



Changeover Switch

With OFF (60°)

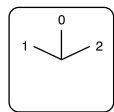

Type#	Description	Unit LP* ₹									Std. pkg. (nos.)
		6A (001)	10A (102)	16A (103)	20A (104)	25A (205)	32A (206)	40A (207)	63A (208)	100A (309)	
3LD4 ___ 1BB10-ORCO	1P 2W	195.-	360.-	435.-	450.-	460.-	510.-	690.-	935.-	4685.-	1
3LD4 ___ 2BB10-ORCO	2P 2W	260.-	435.-	490.-	580.-	620.-	725.-	945.-	1420.-	6855.-	
3LD4 ___ 3BB10-ORCO	3P 2W	320.-	540.-	660.-	815.-	940.-	1020.-	1195.-	1910.-	8875.-	
3LD4 ___ 4BB10-ORCO NEW	4P 2W	390.-	600.-	760.-	995.-	1250.-	1315.-	1460.-	2415.-	11315.-	



Without OFF (90°)

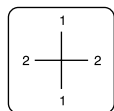

Type#	Description	Unit LP* ₹									Std. pkg. (nos.)
		6A (001)	10A (102)	16A (103)	20A (104)	25A (205)	32A (206)	40A (207)	63A (208)	100A (309)	
3LD4 ___ 1PC10-ORCO	1P 2W	195.-	360.-	435.-	440.-	460.-	510.-	690.-	935.-	4685.-	1
3LD4 ___ 2PC10-ORCO	2P 2W	260.-	435.-	490.-	580.-	620.-	725.-	945.-	1420.-	6855.-	
3LD4 ___ 3PC10-ORCO	3P 2W	320.-	540.-	660.-	815.-	940.-	1020.-	1195.-	1910.-	8875.-	
3LD4 ___ 4PC10-ORCO NEW	4P 2W	390.-	600.-	760.-	995.-	1250.-	1315.-	1460.-	2415.-	11315.-	

Phase Changeover Switch (PCS)

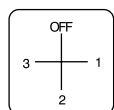

Type#	Description	Unit LP* ₹									Std. pkg. (nos.)
		6A (001)	10A (102)	16A (103)	20A (104)	25A (205)	32A (206)	40A (207)	63A (208)	100A (309)	
3LD4 ___ 1CC10-ORCO	1P 3W	230.-	315.-	370.-	435.-	440.-	550.-	805.-	900.-	3850.-	1



* Fill in the 3rd, 4th & 5th digit of the type nos with the digits in () to get complete MLFB
e.g. for 10A 3 Pole Changeover with OFF (60°) the complete type no will be 3LD41023BB10-ORCO

Multistep Switch

NEW



Multistep 3 Way with OFF

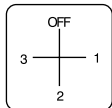

Type#	Description	Unit LP* ₹									Std. pkg. (nos.)
		6A (001)	10A (102)	16A (103)	20A (104)	25A (205)	32A (206)	40A (207)	63A (208)	100A (309)	
3LD4 ___ 1CC40-ORCO	1P 3W	230.-	390.-	455.-	470.-	490.-	555.-	785.-	885.-	4805.-	1
3LD4 ___ 2CC40-ORCO	2P 3W	320.-	460.-	555.-	660.-	755.-	810.-	1165.-	1310.-	7060.-	
3LD4 ___ 3CC40-ORCO	3P 3W	460.-	615.-	935.-	1005.-	1115.-	1215.-	1550.-	2025.-	9225.-	
3LD4 ___ 4CC40-ORCO	4P 3W	590.-	790.-	1135.-	1245.-	1390.-	1530.-	2080.-	2425.-	11655.-	

Multistep 4 Way with OFF

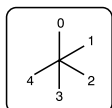

Type#	Description	Unit LP* ₹									Std. pkg. (nos.)
		6A (001)	10A (102)	16A (103)	20A (104)	25A (205)	32A (206)	40A (207)	63A (208)	100A (309)	
3LD4 ___ 1DD40-ORCO	1P 4W	265.-	350.-	660.-	715.-	790.-	880.-	1000.-	1355.-	4250.-	1
3LD4 ___ 2DD40-ORCO	2P 4W	460.-	665.-	780.-	800.-	835.-	970.-	1250.-	1580.-	6195.-	
3LD4 ___ 3DD40-ORCO	3P 4W	640.-	890.-	1240.-	1295.-	1390.-	1600.-	2130.-	2425.-	17060.-	

Multistep 5 Way with OFF

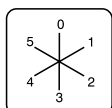

Type#	Description	Unit LP* ₹									Std. pkg. (nos.)
		6A (001)	10A (102)	16A (103)	20A (104)	25A (205)	32A (206)	40A (207)	63A (208)	100A (309)	
3LD4 ___ 1EE40-ORCO	1P 5W	295.-	560.-	760.-	860.-	990.-	1005.-	1240.-	1445.-	4265.-	1
3LD4 ___ 2EE40-ORCO	2P 5W	540.-	870.-	1010.-	1165.-	1350.-	1580.-	1625.-	2030.-	6190.-	

Multistep 6 Way with OFF

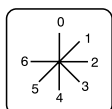

Type#	Description	Unit LP* ₹								Std. pkg. (nos.)
		6A (001)	10A (102)	16A (103)	20A (104)	25A (205)	32A (206)	40A (207)	63A (208)	
3LD4 ___ 1FF40-ORCO	1P 6W	385.-	625.-	730.-	805.-	880.-	1025.-	1055.-	1705.-	1
3LD4 ___ 2FF40-ORCO	2P 6W	640.-	945.-	1065.-	1200.-	1355.-	1640.-	2100.-	2740.-	

Multistep 7 Way with OFF

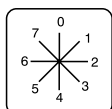

Type#	Description	Unit LP* ₹								Std. pkg. (nos.)
		6A (001)	10A (102)	16A (103)	20A (104)	25A (205)	32A (206)	40A (207)	63A (208)	
3LD4 ___ 1GG40-ORCO	1P 7W	390.-	650.-	800.-	875.-	1005.-	1050.-	1090.-	1695.-	1

* LP - List Price

Multistep Switch

NEW

Multistep 8 Way with OFF

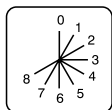

Type#	Description	Unit LP* ₹				Std. pkg. (nos.)
		6A (001)	10A (102)	16A (103)	20A (104)	
3LD4 ___ 1HH40-ORCO	1P 8W	445.-	550.-	785.-	915.-	1

Multistep 9 Way with OFF

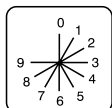

Type#	Description	Unit LP* ₹				Std. pkg. (nos.)
		6A (001)	10A (102)	16A (103)	20A (104)	
3LD4 ___ 1JJ40-ORCO	1P 9W	460.-	670.-	815.-	970.-	1

Multistep 10 Way with OFF

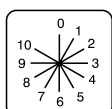

Type#	Description	Unit LP* ₹				Std. pkg. (nos.)
		6A (001)	10A (102)	16A (103)	20A (104)	
3LD4 ___ 1KK40-ORCO	1P 10W	540.-	705.-	1090.-	1470.-	1

Multistep 11 Way with OFF

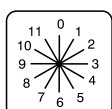

Type#	Description	Unit LP* ₹				Std. pkg. (nos.)
		6A (001)	10A (102)	16A (103)	20A (104)	
3LD4 ___ 1LL40-ORCO	1P 11W	640.-	770.-	1200.-	1580.-	1

Fill in the 3rd, 4th & 5th digit of the type nos with the digits in () to get complete MLFB e.g. for 6A 3 Pole Multistep 4 Way with OFF the complete type no will be 3LD40013DD40-ORCO

* LP - List Price



Multistep Switch

NEW



Multistep 3 Way without OFF

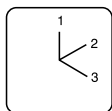

Type#	Description	Unit LP* ₹									Std. pkg. (nos.)
		6A (001)	10A (102)	16A (103)	20A (104)	25A (205)	32A (206)	40A (207)	63A (208)	100A (309)	
3LD4 ___ 1QB40-ORCO	1P 3W	220.-	375.-	460.-	470.-	580.-	605.-	930.-	1050.-	3940.-	1
3LD4 ___ 2QB40-ORCO	2P 3W	320.-	570.-	650.-	710.-	765.-	785.-	1165.-	1375.-	7060.-	
3LD4 ___ 3QB40-ORCO	3P 3W	460.-	710.-	970.-	1030.-	1115.-	1215.-	1705.-	2025.-	7575.-	
3LD4 ___ 4QB40-ORCO	4P 3W	590.-	790.-	1120.-	1275.-	1415.-	1505.-	3315.-	3660.-	8125.-	

Multistep 4 Way without OFF

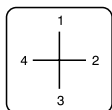

Type#	Description	Unit LP* ₹									Std. pkg. (nos.)
		6A (001)	10A (102)	16A (103)	20A (104)	25A (205)	32A (206)	40A (207)	63A (208)	100A (309)	
3LD4 ___ 1RC40-ORCO	1P 4W	250.-	415.-	560.-	610.-	700.-	730.-	1010.-	1410.-	4805.-	1
3LD4 ___ 2RC40-ORCO	2P 4W	360.-	595.-	660.-	760.-	825.-	900.-	1215.-	1580.-	7420.-	
3LD4 ___ 3RC40-ORCO	3P 4W	485.-	580.-	1050.-	1160.-	1315.-	1460.-	1590.-	2120.-	9780.-	

Multistep 5 Way without OFF

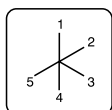

Type#	Description	Unit LP* ₹									Std. pkg. (nos.)
		6A (001)	10A (102)	16A (103)	20A (104)	25A (205)	32A (206)	40A (207)	63A (208)	100A (309)	
3LD4 ___ 1SD40-ORCO	1P 5W	295.-	430.-	605.-	690.-	785.-	970.-	1240.-	1585.-	4245.-	1
3LD4 ___ 2SD40-ORCO	2P 5W	540.-	730.-	825.-	1065.-	1245.-	1340.-	1720.-	2180.-	6100.-	

Multistep 6 Way without OFF

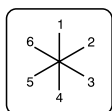

Type#	Description	Unit LP* ₹									Std. pkg. (nos.)
		6A (001)	10A (102)	16A (103)	20A (104)	25A (205)	32A (206)	40A (207)	63A (208)	100A (309)	
3LD4 ___ 1TE40-ORCO	1P 6W	315.-	385.-	755.-	805.-	880.-	1005.-	1170.-	1480.-	7060.-	1
3LD4 ___ 2TE40-ORCO	2P 6W	615.-	745.-	1020.-	1275.-	1560.-	1605.-	1625.-	2075.-	14080.-	

Multistep 7 Way without OFF

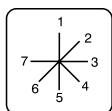

Type#	Description	Unit LP* ₹									Std. pkg. (nos.)
		6A (001)	10A (102)	16A (103)	20A (104)	25A (205)	32A (206)	40A (207)	63A (208)	100A (309)	
3LD4 ___ 1UF40-ORCO	1P 7W	385.-	490.-	570.-	790.-	1040.-	1045.-	1250.-	1860.-	1	

* LP - List Price

Multistep Switch

NEW

Multistep 8 Way without OFF

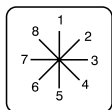

Type#	Description	Unit LP* ₹				Std. pkg. (nos.)
		6A (001)	10A (102)	16A (103)	20A (104)	
3LD4 ___ 1VG40-ORCO	1P 8W	390.-	775.-	855.-	915.-	1

Multistep 9 Way without OFF

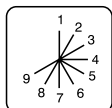

Type#	Description	Unit LP* ₹				Std. pkg. (nos.)
		6A (001)	10A (102)	16A (103)	20A (104)	
3LD4 ___ 1WH40-ORCO	1P 9W	460.-	800.-	1360.-	1685.-	1

Multistep 10 Way without OFF

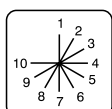

Type#	Description	Unit LP* ₹				Std. pkg. (nos.)
		6A (001)	10A (102)	16A (103)	20A (104)	
3LD4 ___ 1XJ40-ORCO	1P 10W	490.-	820.-	1505.-	2025.-	1

Multistep 11 Way without OFF

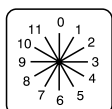

Type#	Description	Unit LP* ₹				Std. pkg. (nos.)
		6A (001)	10A (102)	16A (103)	20A (104)	
3LD4 ___ 1YK40-ORCO	1P 11W	515.-	835.-	1615.-	2135.-	1

Multistep 12 Way without OFF

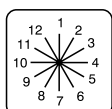

Type#	Description	Unit LP* ₹				Std. pkg. (nos.)
		6A (001)	10A (102)	16A (103)	20A (104)	
3LD4 ___ 1ZL40-ORCO	1P 12W	560.-	855.-	1685.-	2165.-	1

* Fill in the 3rd, 4th & 5th digit of the type nos with the digits in () to get complete MLFB
e.g. for 6A 1 Pole Multistep 4 Way with OFF the complete type no will be 3LD40013DD40-ORCO



Licensed
Partner

For
SIEPAN 8PU

SIEMENS

INDUSTRY 4.0

Welcome to the world of digitalization with LV Panels

Industry 4.0 is a name for the current trend of automation and data exchange in manufacturing technologies. It includes cyber-physical systems, the Internet of things, cloud computing and cognitive computing. Industry 4.0 creates what has been called a "smart factory".

SIEMENS LV Panels helps our customers stride into the new & exciting world of digitalization.

For more information call us on 1800 209 1800

For Life Cycle Support of Products, Systems and Solutions call us on 1800 209 0987

www.siemens.com/sivacon-details

SIEMENS

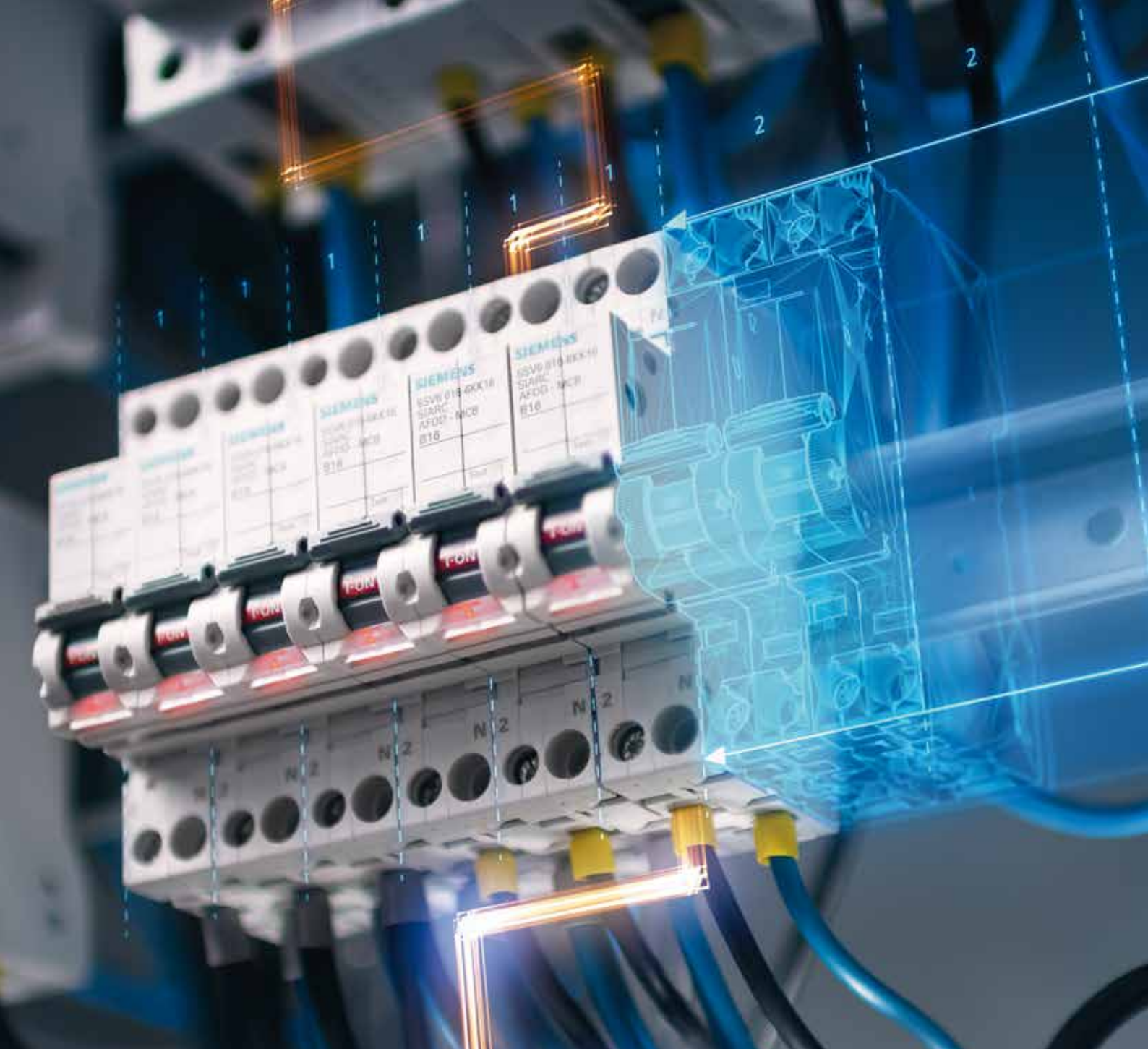

Reliable protection by preventing electrical fires

With Arc Fault Detection Device

With the 5SV6 Arc Fault Detection Device (AFDD), Siemens presents the third generation of fire-prevention product. The 5SV6 Arc Fault Detection Device with integrated miniature circuit breaker (MCB) and residual current breaker operator (RCBO) is the first device on the IEC market with just one module width and is the smallest of its kind worldwide.





A standard-compliant expansion of the electrical installation by protection against electrical fires is thus always possible – easily and without the need for additional space.

www.siemens.com/afd-units

Betagard Miniature Circuit Breakers Type 5SL6 and 5SL4



- Standards: IS/IEC 60898-1:2002
- Voltage: Un 240/415V, 50...60Hz can be used in systems upto 60V DC for 1P and 110V DC for 2P*
- With ISI marking: CML No. 2255548

	I _n A	MW#	7500A		10000A	Std. Pkg. (Nos.)
			Characteristic B	Characteristic C		
	0.5	1	--	5SL61057RC	5SL41057RC	1/12
	1		--	5SL61017RC	--	1/12
	2		--	5SL61027RC	5SL41027RC	1/12
	3		--	5SL61037RC	5SL41037RC	1/12
	4		--	5SL61047RC	5SL41047RC	1/12
	6		5SL61066RC	5SL61067RC	5SL41067RC	1/12
	8		--	5SL61087RC	5SL41087RC	1/12
	10		5SL61106RC	5SL61107RC	5SL41107RC	1/12
	13		--	5SL61137RC	5SL41137RC	1/12
	16		5SL61166RC	5SL61167RC	5SL41167RC	1/12
	20		5SL61206RC	5SL61207RC	5SL41207RC	1/12
	25		5SL61256RC	5SL61257RC	5SL41257RC	1/12
	32		5SL61326RC	5SL61327RC	5SL41327RC	1/12
	40		5SL61406RC	5SL61407RC	5SL41407RC	1/12
	50		5SL61506RC	5SL61507RC	5SL41507RC	1/12
63	5SL61636RC	5SL61637RC	5SL41637RC	1/12		
	0.5	2	--	5SL62057RC	5SL42057RC	1/6
	1		--	5SL62017RC	--	1/6
	2		--	5SL62027RC	5SL42027RC	1/6
	3		--	5SL62037RC	5SL42037RC	1/6
	4		--	5SL62047RC	5SL42047RC	1/6
	6		5SL62066RC	5SL62067RC	5SL42067RC	1/6
	8		--	5SL62087RC	5SL42087RC	1/6
	10		5SL62106RC	5SL62107RC	5SL42107RC	1/6
	13		--	5SL62137RC	5SL42137RC	1/6
	16		5SL62166RC	5SL62167RC	5SL42167RC	1/6
	20		5SL62206RC	5SL62207RC	5SL42207RC	1/6
	25		5SL62256RC	5SL62257RC	5SL42257RC	1/6
	32		5SL62326RC	5SL62327RC	5SL42327RC	1/6
	40		5SL62406RC	5SL62407RC	5SL42407RC	1/6
	50		5SL62506RC	5SL62507RC	5SL42507RC	1/6
63	5SL62636RC	5SL62637RC	5SL42637RC	1/6		
	0.5	3	--	5SL63057RC	5SL43057RC	1/4
	1		--	5SL63017RC	--	1/4
	2		--	5SL63027RC	5SL43027RC	1/4
	3		--	--	5SL43037RC	1/4
	4		--	5SL63047RC	5SL43047RC	1/4
	6		5SL63066RC	5SL63067RC	5SL43067RC	1/4
	8		--	--	5SL43087RC	1/4
	10		5SL63106RC	5SL63107RC	5SL43107RC	1/4
	13		--	--	5SL43137RC	1/4
	16		5SL63166RC	5SL63167RC	5SL43167RC	1/4
	20		5SL63206RC	5SL63207RC	5SL43207RC	1/4
	25		5SL63256RC	5SL63257RC	5SL43257RC	1/4
	32		5SL63326RC	5SL63327RC	5SL43327RC	1/4
	40		5SL63406RC	5SL63407RC	5SL43407RC	1/4
	50		5SL63506RC	5SL63507RC	5SL43507RC	1/4
63	5SL63636RC	5SL63637RC	5SL43637RC	1/4		
	0.5	4	--	5SL64057RC	5SL44057RC	1/3
	1		--	5SL64017RC	--	1/3
	2		--	5SL64027RC	5SL44027RC	1/3
	3		--	--	5SL44037RC	1/3
	4		--	5SL64047RC	5SL44047RC	1/3
	6		5SL64066RC	5SL64067RC	5SL44067RC	1/3
	8		--	--	5SL44087RC	1/3
	10		5SL64106RC	5SL64107RC	5SL44107RC	1/3
	13		--	--	5SL44137RC	1/3
	16		5SL64166RC	5SL64167RC	5SL44167RC	1/3
	20		5SL64206RC	5SL64207RC	5SL44207RC	1/3
	25		5SL64256RC	5SL64257RC	5SL44257RC	1/3
	32		5SL64326RC	5SL64327RC	5SL44327RC	1/3
	40		5SL64406RC	5SL64407RC	5SL44407RC	1/3
	50		5SL64506RC	5SL64507RC	5SL44507RC	1/3
63	5SL64636RC	5SL64637RC	5SL44637RC	1/3		

1 MW (Module Width) = 18 mm

* subject to application specific circuit connections. Kindly contact nearest sales office

Refer latest Electrical Installations from A to Z Price List for prices

Betagard Circuit Breakers

NEW

5SL7 Miniature circuit breaker

- Standards: IS/IEC 60898-1
- Voltage: Un 240/415V, 50...60Hz
- Breaking capacity: upto 15kA
- With ISI marking: CM/L No. 2255548



5SL5 Circuit Breakers

- Standards: IS/IEC 60947-2
- Voltage: 220V DC/1P & 440VDC/2P
- Breaking capacity: 10kA as per IS/IEC 60947-2

	Rated current I _n (A)	MW#	10000A				Std. Pkg. (Nos)	
				Characteristic C	Characteristic D	Characteristic C, DC		
	0.5	1	1P, 240/415V AC	--	--	1P, 220V DC	5SL51057RC	1/12
	1			--	--		5SL51017RC	1/12
	2			5SL71027RC	5SL71028RC		5SL51027RC	1/12
	3			--	--		5SL51037RC	1/12
	4			5SL71047RC	5SL71048RC		5SL51047RC	1/12
	6			5SL71067RC	5SL71068RC		5SL51067RC	1/12
	8			--	--		5SL51087RC	1/12
	10			5SL71107RC	5SL71108RC		5SL51107RC	1/12
	16			5SL71167RC	5SL71168RC		5SL51167RC	1/12
	20			5SL71207RC	5SL71208RC		5SL51207RC	1/12
	25			5SL71257RC	5SL71258RC		5SL51257RC	1/12
	32			5SL71327RC	5SL71328RC		5SL51327RC	1/12
	40			5SL71407RC	5SL71408RC		5SL51407RC	1/12
	50			5SL71507RC	5SL71508RC		5SL51507RC	1/12
63	5SL71637RC	5SL71638RC	5SL51637RC	1/12				
	0.5	2	2P, 415V AC	--	--	2P, 440V DC	5SL52057RC	1/6
	1			--	--		5SL52017RC	1/6
	2			5SL72027RC	5SL72028RC		5SL52027RC	1/6
	3			--	--		5SL52037RC	1/6
	4			5SL72047RC	5SL72048RC		5SL52047RC	1/6
	6			5SL72067RC	5SL72068RC		5SL52067RC	1/6
	8			--	--		5SL52087RC	1/6
	10			5SL72107RC	5SL72108RC		5SL52107RC	1/6
	16			5SL72167RC	5SL72168RC		5SL52167RC	1/6
	20			5SL72207RC	5SL72208RC		5SL52207RC	1/6
	25			5SL72257RC	5SL72258RC		5SL52257RC	1/6
	32			5SL72327RC	5SL72328RC		5SL52327RC	1/6
	40			5SL72407RC	5SL72408RC		5SL52407RC	1/6
	50			5SL72507RC	5SL72508RC		5SL52507RC	1/6
63	5SL72637RC	5SL72638RC	5SL52637RC	1/6				
	2	3	3P, 415V AC	5SL73027RC	5SL73028RC	--	--	1/4
	4			5SL73047RC	5SL73048RC	--	--	1/4
	6			5SL73067RC	5SL73068RC	--	--	1/4
	10			5SL73107RC	5SL73108RC	--	--	1/4
	16			5SL73167RC	5SL73168RC	--	--	1/4
	20			5SL73207RC	5SL73208RC	--	--	1/4
	25			5SL73257RC	5SL73258RC	--	--	1/4
	32			5SL73327RC	5SL73328RC	--	--	1/4
	40			5SL73407RC	5SL73408RC	--	--	1/4
	50			5SL73507RC	5SL73508RC	--	--	1/4
63	5SL73637RC	5SL73638RC	--	--	1/4			
	2	4	4P, 415V AC	5SL74027RC	5SL74028RC	--	--	1/3
	4			5SL74047RC	5SL74048RC	--	--	1/3
	6			5SL74067RC	5SL74068RC	--	--	1/3
	10			5SL74107RC	5SL74108RC	--	--	1/3
	16			5SL74167RC	5SL74168RC	--	--	1/3
	20			5SL74207RC	5SL74208RC	--	--	1/3
	25			5SL74257RC	5SL74258RC	--	--	1/3
	32			5SL74327RC	5SL74328RC	--	--	1/3
	40			5SL74407RC	5SL74408RC	--	--	1/3
	50			5SL74507RC	5SL74508RC	--	--	1/3
63	5SL74637RC	5SL74638RC	--	--	1/3			

1 MW (Module Width) = 18 mm

Refer latest Electrical Installations from A to Z Price List for prices



| Geared to act *FAST!*

Siemens range of fuses

Fuses are the fastest & simplest current limiting devices, suitable for protection of lines, systems, devices in both distribution & control circuits.

Available in varied design - with a wide current range, multiple voltage ratings and high short circuit strength. Our fuses are perfectly equipped to minimize the effect of over currents, thus allowing you to protect property as well as lives.

Siemens Fuses offer:

- High switching capacity
- Compact Design
- Low Watt Losses

With Siemens fuses - protection is Easy, Safe and Reliable

www.siemens.com/fuses

SIEMENS

HRC fuses (DIN) 3NA

- High Breaking capacity of 120kA
- Dual indication for fault detection
- CE marked
- Highly compact: upto 100A in size 000



Upto 800A, 500V AC, S.C. breaking capacity 120kA

Size	Rated current (A)	Type	Unit MRP [®] ₹	Std. pkg.** (nos.)
000	2	3NA78020RC	405.-	1/6
	4	3NA78040RC	405.-	1/6
	6	3NA78010RC	405.-	1/6
	10	3NA78030RC	405.-	1/6
	16	3NA78050RC	410.-	1/6
	20	3NA78070RC	410.-	1/6
	25	3NA78100RC	410.-	1/6
	32	3NA78120RC	410.-	1/6
	40	3NA78170RC	435.-	1/6
	50	3NA78200RC	435.-	1/6
	63	3NA78220RC	480.-	1/6
	80	3NA78240RC	525.-	1/6
	100	3NA78300RC	525.-	1/6
	00	125	3NA78320RC	635.-
160		3NA78360RC	665.-	1/6
50		3NA71200RC	895.-	1/3
63		3NA71220RC	895.-	1/3
1	80	3NA71240RC	895.-	1/3
	100	3NA71300RC	895.-	1/3
	125	3NA71320RC	935.-	1/3
	160	3NA71360RC	965.-	1/3
	200	3NA71400RC	965.-	1/3
	224	3NA71420RC	1000.-	1/3
	250	3NA71440RC	1080.-	1/3
2	200	3NA72400RC	1335.-	1/3
	250	3NA72440RC	1385.-	1/3
	315	3NA72520RC	1435.-	1/3
3	400*	3NA72600RC	1435.-	1/3
	315	3NA33520RC	2040.-	1/3
	400	3NA33600RC	2040.-	1/3
	500	3NA33650RC	2280.-	1/3
	630	3NA33720RC	2335.-	1/3
	800*	3NA33754RC	2840.-	1/3

* 400A (Size II) and 800A are rated at 415V AC

690V AC, S.C. breaking capacity 120kA

Size	Rated current (A)	Type	Unit MRP [®] ₹	Std. pkg.** (nos.)
00	40	3NA78176RC	590.-	1/6
	50	3NA78206RC	590.-	1/6
	63	3NA78226RC	635.-	1/6
	80	3NA78246RC	665.-	1/6
1	100	3NA78306RC	665.-	1/6
	125	3NA71326RC	1150.-	1/3
	160	3NA71366RC	1195.-	1/3
2	200	3NA71406RC	1195.-	1/3
	250	3NA72446RC	1580.-	1/3
3	315	3NA72526RC	1695.-	1/3
	400	3NA33606RC	2535.-	1/3
	425	3NA33626RC	2535.-	1/3
	500	3NA33656RC	2705.-	1/3

Isolating links (DIN)

Size	Rated current (A)	Type	Unit MRP [®] ₹	Std. pkg.** (nos.)
00	160	3NG1000	435.-	1
1	250	3NG1250	650.-	1
2	400	3NG1300	1065.-	1
3	630	3NG1400	1105.-	1



Fuse bases (DIN)

Size	Rated current (A)	Suitable for fuse link type	Type	Unit MRP [®] ₹	Std. pkg.** (nos.)
00/000	160	3NA7 8	3NH3030-ORC (Screw-in)	530.-	1/10
00/000	160	3NA7 8	3NH3032-ORC (Plug in)	560.-	1/10
1	250	3NA7 1	3NH3230-ORC	1060.-	1/5
2	400	3NA7 2	3NH3330-ORC	1500.-	1/5
3	630	3NA3 3	3NH3430-ORC	2160.-	1/5
3	800	3NA3 3	3NH3430-4RC	2555.-	1/5



Fuse puller

Description	Type	Unit MRP [®] ₹	Std. pkg.** (nos.)
Suitable for 3KL8 and all sizes of fuse links/isolating links	3NX1011	2590.-	1
Suitable only for fuse links and isolating links	3NX1010	1080.-	1



LV HRC contact covers

Size	Type	Unit LP* ₹	Std. pkg.** (nos.)
00/000	3NX3115	545.-	1/10
00/000	3NX3116	340.-	1/10



Note: Prices on request for Touch protection of contact pieces of all sizes

Fuse & Fuse base for 1000A/1250A (IEC design)

Size	Rating	Type	Unit LP* ₹	Std. pkg.** (nos.)
4	1000A	3NA3480	Price on request	1/1
4	1250A	3NA3482		1/1
4	1250A	3NH3530 Fuse base		1/1



690V AC, S.C. breaking capacity 120kA

Size	Rated current (A)	Type	Unit LP* ₹
000	2A	3NA78026	Price on request
	4A	3NA78046	
	6A	3NA78016	
	10A	3NA78036	
	16A	3NA78056	
	20A	3NA78076	
	25A	3NA78106	
	32A	3NA78126	
	35A	3NA78146	

** Purchase MOQ for our authorised dealers is in multiples of standard packing, contact Siemens Sales Office for further details

■ Stock items

* LP - List Price

® MRP - Max. Retail Price

HRC fuses (BS) 3NW

- 2A-800A
- Rated at 415V AC/240V DC
- Breaking capacity 80kA (AC)



Blade tag

Rated current A	Type	Unit MRP* ₹	Std. pkg.** (nos.)
2	■ 3NWNS2	110.-	20
4	■ 3NWNS4	110.-	20
6	■ 3NWNS6	110.-	20
10	■ 3NWNS10	110.-	20
16	■ 3NWNS16	110.-	20
20	■ 3NWNS20	125.-	20
25	■ 3NWNS25	125.-	20
32	■ 3NWNS32	125.-	20

Offset tag

Rated current A	Type	Unit MRP* ₹	Std. pkg.** (nos.)
2	3NWTIA2	155.-	20
4	3NWTIA4	155.-	20
6	3NWTIA6	155.-	20
10	■ 3NWTIA10	155.-	20
16	■ 3NWTIA16	155.-	20
20	■ 3NWTIA20	155.-	20
25	■ 3NWTIA25	155.-	20
32	■ 3NWTIA32	155.-	20
40	3NWTIS40	235.-	20
50	■ 3NWTIS50	235.-	20
63	■ 3NWTIS63	235.-	20
80	3NWTCP80	615.-	10
100	■ 3NWTCP100	615.-	10
125	3NWTFP125	970.-	5
160	3NWTFP160	970.-	5
200	3NWTFP200	970.-	5

Central tag

Rated current A	Type	Unit MRP* ₹	Std. pkg.** (nos.)
80	3NWT80	655.-	10
100	3NWT100	655.-	10
125	3NWT125	1060.-	5
160	3NWT160	1060.-	5
200	3NWT200	1060.-	5
250	3NWT250	1460.-	1
315	3NWT315	1460.-	1
355	3NWT355	2015.-	1
400	3NWT400	2015.-	1
500	3NWT500	3170.-	1
630	3NWT630	4185.-	1
710	3NWT710	4780.-	1
800	3NWT800	4780.-	1

Offset tag

Rated current A	Type	Unit MRP* ₹	Std. pkg.** (nos.)
6	3NWTSA6	125.-	20
10	3NWTSA10	125.-	20
16	3NWTSA16	125.-	20
20	3NWTSA20	125.-	20
25	3NWTSA25	125.-	20
32	3NWTSA32	125.-	20
36	3NWTSS36	260.-	20
40	3NWTSS40	260.-	20
50	3NWTSS50	260.-	20
63	3NWTSS63	260.-	20
80	3NWTSDS80	375.-	20
100	3NWTSDS100	375.-	20
125	3NWTFF125	610.-	5
160	3NWTFF160	610.-	5
200	3NWTFF200	610.-	5

Central tag

Rated current A	Type	Unit MRP* ₹	Std. pkg.** (nos.)
80	3NWTSDC80	455.-	10
100	3NWTSDC100	455.-	10
125	3NWTSF125	615.-	5
160	3NWTSF160	615.-	5
200	3NWTSF200	615.-	5
250	3NWTSK250	1145.-	1
315	3NWTSK315	1145.-	1
355	3NWTSM355	1910.-	1
400	3NWTSM400	1910.-	1
450	3NWTST450	1880.-	1
500	3NWTST500	1880.-	1
560	3NWTSL560	3035.-	1
630	3NWTSL630	3035.-	1
800	3NWTSL800	4380.-	1

Fuse holders (for fuses type 3NW TIA, TSA, TIS, TSS, TSDS)

Rated current A	Type	Unit MRP* ₹	Std. pkg.** (nos.)
32	3NWC32F9	1840.-	10
63	3NWC63F9	2160.-	10
100	3NWC100F9	2380.-	10

Fuse holders (for fuses Type 3NW NS) & Isolating link

Rated current A	Type	Unit MRP* ₹	Std. pkg.** (nos.)
20	■ 3NW20NNSF	230.-	10
32	■ 3NW32NNSF	290.-	10
32A (Iso. Link)	■ 3NW32NNSL	125.-	10

** Purchase MOQ for our authorised dealers is in multiples of standard packing, contact Siemens Sales Office for further details

■ Stock items

* MRP - Maximum Retail Price

Please order in multiples of standard packing.

Fuses for semiconductor protection - SITOR 3NE / 3NC

- Current Range upto 2400A
- Operating voltage: 500V - 2500V AC
- Suitable for mounting in fuse base / SDF / busbars



3NE4 type

Rated voltage V	Rated current (A)	Type	Utilization category	DIN size	Unit LP* ₹	Std. pkg.** (nos.)
1000	32	3NE4101	gR	1	2275.-	1
	40	3NE4102	gR	1	2285.-	1
	50	3NE4117	gR	1	2400.-	1
	80	3NE4120	aR	1	2590.-	1
	100	3NE4121	aR	1	2840.-	1
	125	3NE4122	aR	1	3050.-	1
	160	3NE4124	aR	1	3360.-	1



3NE9 type 600 V AC

Rated current (A)	Type	Utilization category	Size	Unit LP* ₹	Std. pkg.** (nos.)
850	3NE94406	gR	-	26710.-	3
1250	3NE9450	aR	-	25170.-	3

3NE1 type¹⁾ 690 V AC

Rated current (A)	Type	Utilization category	DIN Size	Unit LP* ₹	Std. pkg.** (nos.)
16	3NE18130	gS	000	5450.-	3
20	3NE18140	gS	000	5450.-	3
25	3NE18150	gS	000	5450.-	3
35	3NE18030	gS	000	5450.-	3
40	3NE18020	gS	000	5450.-	3
50	3NE18170	gS	000	5450.-	3
63	3NE18180	gS	000	5450.-	3
80	3NE18200	gS	000	5450.-	3
100	3NE10210	gS	00	7160.-	3
125	3NE10220	gS	00	7160.-	3
160	3NE12240	gS	1	17360.-	3
200	3NE12250	gS	1	17360.-	3
250	3NE12270	gS	1	18230.-	3
315	3NE12300	gS	1	19545.-	3
350	3NE13310	gS	2	24270.-	3
400	3NE13320	gS	2	24485.-	3
450	3NE13330	gS	2	24635.-	3
500	3NE13340	gS	2	25005.-	3
560	3NE14350	gS	3	25140.-	3
630	3NE14360	gS	3	26230.-	3
710	3NE14370	gS	3	27280.-	3
800	3NE14380	gS	3	31960.-	3



Rated voltage V	Rated current (A)	Type	Utilization category	DIN size	Unit LP* ₹	Std. pkg.** (nos.)
800	250	3NE43276	aR	-	6595.-	1
	315	3NE43306	aR	-	6810.-	1
	450	3NE43336	aR	-	7120.-	1
	500	3NE43346	aR	-	7175.-	1
	710	3NE43376	aR	-	8025.-	1



3NE8 type¹⁾ 690 V AC

NEW

Rated current (A)	Type	Utilization category	Size	Unit LP* ₹	Std. pkg.** (nos.)
25	3NE80151	gR	00	4625.-	3
35	3NE80031	gR	00	4625.-	3
50	3NE80171	gR	00	4625.-	3
63	3NE80181	gR	00	4625.-	3
80	3NE80201	aR	00	5135.-	3
100	3NE80211	aR	00	5370.-	3
125	3NE80221	aR	00	5450.-	3
160	3NE80241	aR	00	5985.-	3
200	3NE12252	gR	1	15790.-	3
250	3NE12272	gR	1	16330.-	3
315	3NE12302	gR	1	16890.-	3
350	3NE13312	gR	2	22355.-	3
400	3NE13322	gR	2	28710.-	3
450	3NE13332	gR	2	24020.-	3
500	3NE13342	gR	2	24965.-	3
560	3NE14352	gR	3	31020.-	3
630	3NE14362	gR	3	32185.-	3
670	3NE14472	gR	3	32890.-	3
710	3NE14372	gR	3	34295.-	3
800	3NE14382	gR	3	36860.-	3
850	3NE14482	gR	3	40120.-	3



3NE8 type 690 V AC / 700V DC

Rated current (A)	Type	Utilization category	Size	Unit LP* ₹	Std. pkg.** (nos.)
20	3NE87141	gR	000	Price on request	10
25	3NE87151	gR	000		10
32	3NE87011	gR	000		10
40	3NE87021	gR	000		10
50	3NE87171	gR	000		10
63	3NE87181	aR	000		10
80	3NE87201	aR	000		10
100	3NE87211	aR	000		10
125	3NE87221	aR	000		10
160	3NE87241	aR	000		10
200	3NE87251	aR	000		10
250	3NE87271	aR	000		10
315	3NE87311	aR	000		10



Note: For current ratings > 1600A ,Operating voltage > 2000V AC please contact our nearest sales office.

¹⁾ Suitable for mounting on fuse base / 3KL8 / 3NP1

** Purchase MOQ for our authorised dealers is in multiples of standard packing, contact Siemens Sales Office for further details

■ Stock items

* LP - List Price

Please order in multiples of standard packing.

Fuses for semiconductor protection - SITOR 3NE / 3NC



3NE3 type
1000 V AC

Rated current (A)	Type	Utilization category	DIN Size	Unit LP* ₹	Std. pkg.** (nos.)
100	3NE3221	aR	1	12930.-	3
125	3NE3222	aR	1	13300.-	3
160	3NE3224	aR	1	13300.-	3
200	3NE3225	aR	1	14030.-	3
250	3NE3227	aR	1	14400.-	3
315	3NE32300B	aR	1	14990.-	3
350	3NE3231	aR	1	17800.-	3
400	3NE32320B	aR	1	19065.-	3
450	3NE3233	aR	1	19745.-	3
400	3NE33320B	aR	2	19250.-	3
450	3NE3333	aR	2	20270.-	3
500	3NE33340B	aR	2	20655.-	3
560	3NE3335	aR	2	21430.-	3
630	3NE3336	aR	2	22450.-	3
710*	3NE33378	aR	2	32085.-	3
800*	3NE33388	aR	2	32970.-	3
900*	3NE33408	aR	2	39275.-	3

Rated current (A)	Type	Utilization category	DIN Size	Unit LP* ₹	Std. pkg.** (nos.)
630	3NC33361U	aR	3	Price on request	1/3
710	3NC33371U	aR	3		1/3
800	3NC33381U	aR	3		1/3
900	3NC33401U	aR	3		1/3
1000	3NC33411U	aR	3		1/3
1100	3NC33421U	aR	3		1/3
1250	3NC33431U	aR	3		1/3

* 710A: 900V AC; 800A: 800V AC; 900A: 690V AC



3NC type
690V AC

Rated current (A)	Type	Utilization category	DIN Size	Unit LP* ₹	Std. pkg.** (nos.)
150	3NC84233C	gR	3	25325.-	3
200	3NC84253C	gR	3	17665.-	3
250	3NC84273C	gR	3	20205.-	3
350	3NC84313C	gR	3	20830.-	3
500	3NC84343C	gR	3	22510.-	3
1000*	3NC84443C	aR	3	40905.-	3

* 1000A, 600V AC



3NE5 type
1500 V AC

Rated current (A)	Type	Utilization category	DIN Size	Unit LP* ₹	Std. pkg.** (nos.)
160	3NE54240C	aR	3	37960.-	2
224	3NE54260C	aR	3	41530.-	2
250	3NE56270C	aR	3	38525.-	3
315	3NE54300C	aR	3	39670.-	2
350	3NE54310C	aR	3	37090.-	2
450	3NE56330C	aR	3	41785.-	3
600	3NE56430C	aR	3	43825.-	3



3NE7 type
2000 V AC

Rated current (A)	Type	Utilization category	DIN Size	Unit LP* ₹	Std. pkg.** (nos.)
200	3NE74250U	aR	3	Price on request	2
250	3NE74270U	aR	3		2
350	3NE74310U	aR	3		2
400	3NE74320U	aR	3		2
450	3NE76331U	aR	3		2
525	3NE76481U	aR	3		2
630	3NE76361U	aR	3		2
710	3NE76371U	aR	3		2

Fuse bases for SITOR fuses

- With bolt-on links or slotted blade contacts
- 1-pole



Version mm	For fuse series	I_n A	U_n V AC / V DC	Con-nection bolt	Type	Unit LP* ₹	Std. pkg. (nos.)		
75	3NC18	50	690	M5	3NH5723	Price on request	1/3		
80	3NE87, 3NC26	315	690	M8	3NH5023		1/3		
	3NE80...3MK	400	690	M10	3NH5323		1/3		
	3NC32...1U, 3NE82...3MK	1600	690	M10	3NH5423				
110	3NC24, 3NC33...1U, 3NC34...1U, 3NC84, 3NE1...-3, 3NE32, 3NE33, 3NE34	1250	1250	M10	3NH5463	Price on request	1/3		
	170	3NE53, 3NE56	630	1800	M10			3NH5473	1/3

Utilization category as per VDE 0636/IEC 60269

Semiconductor aR, gR, gS
Cable & Conductor gG
Motor aM

1st letter

a = Partial range of protection (accompanied fuses)
g = Complete range protection (general purpose fuses)

2nd letter

G(-L) = Cable & conductor protection (general purpose fuses)
M = Motor protection
R, S = Semiconductor protection

** Purchase MOQ for our authorised dealers is in multiples of standard packing, contact Siemens Sales Office for further details

* LP - List Price

Please order in multiples of standard packing.

Cylindrical Fuses (3NW)

- Rated current 0.5A-100A
- Breaking capacity 100kA
- Operational Class gG and aM



Cylindrical Fuse, Size 10 x 38

Rated Current (A)	Size	Voltage (V)	Type	Unit LP* ₹	Std. pkg.** (nos.)		
0.5A	10 x 38	500	3NW60001	420.-	1/10		
1A			3NW60111	420.-	1/10		
2A			3NW60021	420.-	1/10		
4A			3NW60041	420.-	1/10		
6A			3NW60011	420.-	1/10		
8A			3NW60081	420.-	1/10		
10A			3NW60031	420.-	1/10		
12A			3NW60061	420.-	1/10		
16A			3NW60051	420.-	1/20		
20A			3NW60071	420.-	1/20		
25A			3NW60101	420.-	1/20		
32A			3NW60121	420.-	1/20		
			400	500			

Cylindrical Fuse, Size 14 x 51

Rated Current (A)	Size	Voltage (V)	Type	Unit LP* ₹	Std. pkg.** (nos.)		
4A	14 x 51	690	3NW61041	465.-	1/10		
6A			3NW61011	465.-	1/10		
8A			3NW61081	465.-	1/10		
10A			3NW61031	465.-	1/10		
12A			3NW61061	465.-	1/10		
16A			3NW61051	465.-	1/10		
20A			3NW61071	465.-	1/10		
25A			3NW61101	465.-	1/10		
32A			3NW61121	545.-	1/10		
40A			500	690	3NW61171	545.-	1/10
50A		3NW61201			545.-	1/10	



Cylindrical Fuse, Size 22 x 58

Rated Current (A)	Size	Voltage (V)	Type	Unit LP* ₹	Std. pkg.** (nos.)		
16A	22 x 58	690	3NW62051	800.-	1/10		
20A			3NW62071	800.-	1/10		
25A			3NW62101	800.-	1/10		
32A			3NW62121	800.-	1/10		
40A			3NW62171	880.-	1/10		
50A			3NW62201	880.-	1/10		
63A			500	690	3NW62221	880.-	1/10
80A					3NW62241	880.-	1/10
100A					3NW62301	985.-	1/10



Cylindrical Fuse holders

No of Poles	Size	Rating (A)	MW	Type	Unit LP* ₹	Std. pkg.** (nos.)
1P	10 x 38	32A	1	3NW7013	750.-	1/1
	14 x 51	50A	1.5	3NW7111	2365.-	1/1
	22 x 58	100A	2	3NW7211	4135.-	1/1
1+N	10 x 38	32A	1	3NW7053	1525.-	1/1
	14 x 51	50A	3	3NW7151	5680.-	1/1
	22 x 58	100A	4	3NW7251	7925.-	1/1
2P	10 x 38	32A	2	3NW7023	1490.-	1/1
	14 x 51	50A	3	3NW7121	4715.-	1/1
	22 x 58	100A	4	3NW7221	6625.-	1/1
3P	10 x 38	32A	3	3NW7033	2245.-	1/1
	14 x 51	50A	4.5	3NW7131	7065.-	1/1
	22 x 58	100A	6	3NW7231	9955.-	1/1

* LP - List Price

Note: Prices for 1+N and 3+N Fuse holder on request

Fuse Systems Available

1. Fuses for Photovoltaic application (DC 1000V / 1500V)
2. NEOZED Fuses & Busbar system up to 100A
3. Diazed fuse systems up to 63A
3. Class CC UL fuse links up to 30A

For more details please contact your nearest sales office.



Fuses for Special Applications

1. Rectifiers in Electrolysis system
2. SITOR 8QG 10/11 thyristor sets
3. Mounting in railway supply rectifier

For more details please contact your nearest sales office.





SENTRON 3NA COM LV HRC fuse link – safety through transparency

Optimize the operation of your plants with consistent data that's constantly available when and where you need it – whether in the cloud using higher-level analysis tools, via a PC using the SENTRON power manager power monitoring software, or directly at the plant via a mobile device using the SENTRON power config mobile app.

In the event of a fault, detecting and locating power failures are time-consuming and costly. Smart local grids are only as smart as their individual components. The measurement and communication-capable 3NA COM LV HRC fuse link makes transformer substations smart and enables them to be integrated in digital systems.

Communication Capable Fuse Link offers:

- Transparency for the local grid transformer station
- Easy retrofit
- Powerful interface for digitalization
- Sustainable and robust design

With Siemens fuses - protection is Easy, Safe and Reliable

www.siemens.com/fuses

SIEMENS



Power Quality Solutions

www.siemens.co.in

SIEMENS

SIECAP™ LV Power Capacitors

ND (Normal Duty) - Al Can, MPP resin filled

- High pulse current withstand capability (upto 200.Ir)
- Long life expectancy upto 100000 hrs
- Self healing type
- Inbuilt over pressure disconnecter
- Shock hazard protected SIGUT terminals



Rated voltage V	kvar @ 50 Hz	Type	Unit LP* ₹	Std. pkg. (nos.)
440	0.9	4RB2008-3EE50-8K	330.-	1
	1	4RB2010-3EE50-8K	365.-	1
	1.2	4RB2012-3EE50-8K	430.-	1
	1.5	4RB2015-3EE50-8K	535.-	1
	2.1	4RB2021-3EE50-8K	760.-	1
	2.5	4RB2025-3EE50-8K	900.-	1
	3	4RB2030-3EE50-8K	1085.-	1
	4.2	4RB2042-3EE50-8K	1510.-	1
	5	4RB2050-3EE50-8K	1800.-	1
	6	4RB2060-3EE50-8K	1900.-	1
	7	4RB2070-3EE50-8K	2220.-	1
	7.5	4RB2075-3EE50-8K	2380.-	1
	8.3	4RB2083-3EE50-8K	2635.-	1
	9	4RB2090-3EE50-8K	2855.-	1
	10	4RB2100-3EE50-8K	3175.-	1
	12.5	4RB2125-3EE50-8K	3425.-	1
	15	4RB2150-3EE50-8K	4110.-	1
	16.7	4RB2167-3EE50-8K	4570.-	1
	20	4RB2200-3EE50-8K	5470.-	1
	20.8	4RB2208-3EE50-8K	5695.-	1
25	4RB2250-3EE50-8K	6850.-	1	
28	4RB2280-3EE50-8K	7670.-	1	
30	4RB2300-3EE50-8K	8220.-	1	

Rated voltage V	kvar @ 50 Hz	Type	Unit LP* ₹	Std. pkg. (nos.)
480	1	4RB2010-3EJ50-8K	380.-	1
	1.5	4RB2015-3EJ50-8K	570.-	1
	2	4RB2020-3EJ50-8K	750.-	1
	2.5	4RB2025-3EJ50-8K	930.-	1
	4.2	4RB2042-3EJ50-8K	1580.-	1
	5	4RB2050-3EJ50-8K	1660.-	1
	5.5	4RB2055-3EJ50-8K	2065.-	1
	8.3	4RB2083-3EJ50-8K	2755.-	1
	10.4	4RB2104-3EJ50-8K	3450.-	1
	11.1	4RB2111-3EJ50-8K	3200.-	1
	12.5	4RB2125-3EJ50-8K	3610.-	1
	13.8	4RB2138-3EJ50-8K	3980.-	1
	15	4RB2150-3EJ50-8K	4325.-	1
	16.7	4RB2167-3EJ50-8K	4810.-	1
	20.8	4RB2208-3EJ50-8K	6000.-	1
	25	4RB2250-3EJ50-8K	7205.-	1
	27.7	4RB2277-3EJ50-8K	7985.-	1
	30	4RB2300-3EJ50-8K	8650.-	1

* Purchase MOQ for our dealers is in multiples of standard packing, contact Siemens Sales Office for further details

For information upon other kvar ratings at different voltages and frequency please contact Siemens Sales Office



Std. Pkg. = 1 unit

* LP - List Price

SIECAP™ LV Power Capacitors

SHD (Super Heavy Duty) - Al Can, MPP resin filled

- High pulse current withstand capability (upto 500.Ir)
- Long life expectancy upto 200000 hrs
- Self healing type
- Inbuilt over pressure disconnecter
- Shock hazard protected SIGUT terminals



Rated voltage V	kvar @ 50 Hz	Type	Unit LP* ₹	Std. pkg. (nos.)
415	5	4RB1050-3EB50-8K	2520.-	1
	6.3	4RB1063-3EB50-8K	3170.-	1
	7.5	4RB1075-3EB50-8K	3770.-	1
	10.4	4RB1104-3EB50-8K	5230.-	1
	12.5	4RB1125-3EB50-8K	5675.-	1
	15	4RB1150-3EB50-8K	6815.-	1
	20	4RB1200-3EB50-8K	9085.-	1
	25	4RB1250-3EB50-8K	11360.-	1
	28.1	4RB1281-3EB50-8K	12760.-	1
	30	4RB1300-3EB50-8K	13625.-	1
	33	4RB1330-3EB50-8K	14990.-	1
440	1	4RB1010-3EE50-8K	515.-	1
	2	4RB1020-3EE50-8K	1040.-	1
	3	4RB1030-3EE50-8K	1555.-	1
	4	4RB1040-3EE50-8K	2080.-	1
	5	4RB1050-3EE50-8K	2600.-	1
	7.5	4RB1075-3EE50-8K	3770.-	1
	10	4RB1100-3EE50-8K	5030.-	1
	10.4	4RB1104-3EE50-8K	5230.-	1
	12.5	4RB1125-3EE50-8K	5675.-	1
	15	4RB1150-3EE50-8K	6815.-	1
	16.7	4RB1167-3EE50-8K	7585.-	1
	20	4RB1200-3EE50-8K	9085.-	1
	25	4RB1250-3EE50-8K	11360.-	1
	28.1	4RB1281-3EE50-8K	12760.-	1
	30	4RB1300-3EE50-8K	13625.-	1
33.1	4RB1331-3EE50-8K	15035.-	1	

Rated voltage V	kvar @ 50 Hz	Type	Unit LP* ₹	Std. pkg. (nos.)	
480	5	4RB1050-3EJ50-8K	2600.-	1	
	6.3	4RB1063-3EJ50-8K	3270.-	1	
	8.3	4RB1083-3EJ50-8K	4310.-	1	
	10.4	4RB1104-3EJ50-8K	4895.-	1	
	11	4RB1111-3EJ50-8K	5180.-	1	
	12.5	4RB1125-3EJ50-8K	5880.-	1	
	13.8	4RB1138-3EJ50-8K	6500.-	1	
	15	4RB1150-3EJ50-8K	7060.-	1	
	16.7	4RB1167-3EJ50-8K	7855.-	1	
	18.7	4RB1187-3EJ50-8K	8800.-	1	
	20	4RB1200-3EJ50-8K	9415.-	1	
	22	4RB1220-3EJ50-8K	10350.-	1	
	25	4RB1250-3EJ50-8K	11760.-	1	
	28.1	4RB1281-3EJ50-8K	13220.-	1	
	30	4RB1300-3EJ50-8K	14110.-	1	
525	5	4RB1050-3FC50-8K	2675.-	1	
	6.3	4RB1063-3FC50-8K	3380.-	1	
	8.3	4RB1083-3FC50-8K	4445.-	1	
	10.4	4RB1104-3FC50-8K	5060.-	1	
	12.5	4RB1125-3FC50-8K	6085.-	1	
	13.2	4RB1132-3FC50-8K	6425.-	1	
	15	4RB1150-3FC50-8K	7300.-	1	
	16.7	4RB1167-3FC50-8K	8135.-	1	
	20	4RB1200-3FC50-8K	9730.-	1	
	25	4RB1250-3FC50-8K	12170.-	1	
	26.5	4RB1265-3FC50-8K	12900.-	1	
	30	4RB1300-3FC50-8K	14605.-	1	
	33.1	4RB1331-3FC50-8K	16110.-	1	
	690	5.3	4RB1053-3GK50-8K	2665.-	1
		6.9	4RB1068-3GK50-8K	3475.-	1
10.4		4RB1104-3GK50-8K	5230.-	1	
12.5		4RB1125-3GK50-8K	6290.-	1	
14.6		4RB1146-3GK50-8K	7345.-	1	
20		4RB1200-3GK50-8K	10060.-	1	
25		4RB1250-3GK50-8K	12575.-	1	



Need higher rated voltage, transient current withstand, life expectancy etc. for demanding applications...

Watch this space for more!

Robust. Safe. Compact.

*For more information, contact your nearest Siemens sales office

* Purchase MOQ for our dealers is in multiples of standard packing, contact Siemens Sales Office for further details

For information other kvar ratings at different voltages and frequency please contact Siemens Sales Office

Std. Pkg. = 1 unit

* LP - List Price

Harmonics filter

Detuned reactor

Features

- Insulation class H
- High linearity
- Temperature control via micro switch
- Low losses and low noise

Copper Detuned Reactors

Bank size	Detuning factor	Type	Unit LP* ₹
5kvar	5.67%	4KA1220-1AC01-0AA0	14100.-
10kvar	5.67%	4KA1220-3AC01-0AA0	18295.-
12.5kvar	5.67%	4KA1220-4AC01-0AA0	21420.-
15kvar	5.67%	4KA1220-5AC01-0AA0	23140.-
20kvar	5.67%	4KA1220-6AC01-0AA0	24750.-
25kvar	5.67%	4KA1220-7AC01-0AA0	26980.-
50kvar	5.67%	4KA1220-2BC01-0AA0	43740.-
5kvar	7%	4KA1220-1AA01-0AA0	14095.-
10kvar	7%	4KA1220-3AA01-0AA0	18850.-
12.5kvar	7%	4KA1220-4AA01-0AA0	20875.-
15kvar	7%	4KA1220-5AA01-0AA0	23500.-
20kvar	7%	4KA1220-6AA01-0AA0	25035.-
25kvar	7%	4KA1220-7AA01-0AA0	26340.-
50kvar	7%	4KA1220-2BA01-0AA0	46930.-
75kvar	7%	4KA1220-3BA03-0AA0	67500.-
100kvar	7%	4KA1220-4BA03-0AA0	84970.-
5kvar	14%	4KA1220-1AB01-0AA0	19740.-
10kvar	14%	4KA1220-3AB01-0AA0	31025.-
12.5kvar	14%	4KA1220-4AB01-0AA0	34370.-
15kvar	14%	4KA1220-5AB01-0AA0	38085.-
20kvar	14%	4KA1220-6AB01-0AA0	45140.-
25kvar	14%	4KA1220-7AB01-0AA0	49885.-
50kvar	14%	4KA1220-2BB01-0AA0	81010.-
75kvar	14%	4KA1220-3BB03-0AA0	116600.-
100kvar	14%	4KA1220-4BB03-0AA0	162155.-

Aluminium Detuned Reactors

Bank size	Detuning factor	Type	Unit LP* ₹
5kvar	5.67%	4KA1420-1AC01-0AA0	10945.-
10kvar	5.67%	4KA1420-3AC01-0AA0	13360.-
12.5kvar	5.67%	4KA1420-4AC01-0AA0	16005.-
15kvar	5.67%	4KA1420-5AC01-0AA0	18090.-
20kvar	5.67%	4KA1420-6AC01-0AA0	19745.-
25kvar	5.67%	4KA1420-7AC01-0AA0	20880.-
50kvar	5.67%	4KA1420-2BC01-0AA0	36380.-
5kvar	7%	4KA1420-1AA01-0AA0	11155.-
10kvar	7%	4KA1420-3AA01-0AA0	14350.-
12.5kvar	7%	4KA1420-4AA01-0AA0	15875.-
15kvar	7%	4KA1420-5AA01-0AA0	17890.-
20kvar	7%	4KA1420-6AA01-0AA0	19055.-
25kvar	7%	4KA1420-7AA01-0AA0	19865.-
50kvar	7%	4KA1420-2BA01-0AA0	35035.-
75kvar	7%	4KA1420-3BA03-0AA0	47595.-
100kvar	7%	4KA1420-4BA03-0AA0	62245.-
5kvar	14%	4KA1420-1AB01-0AA0	15185.-
10kvar	14%	4KA1420-3AB01-0AA0	22205.-
12.5kvar	14%	4KA1420-4AB01-0AA0	24785.-
15kvar	14%	4KA1420-5AB01-0AA0	28610.-
20kvar	14%	4KA1420-6AB01-0AA0	31770.-
25kvar	14%	4KA1420-7AB01-0AA0	38760.-
50kvar	14%	4KA1420-2BB01-0AA0	68570.-



* LP - List Price

3TS Capacitor duty Contactors

The 3TS capacitor duty contactor (with **patented** de-latching technology) provides a reliable and economical solution for capacitor switching applications.

Features and Benefits

- De-latching operating principle
- SIGUT Termination technique
- Finger touch proof terminals
- Compact Dimensions
- DIN / Screw mounting
- Reliable switching of capacitor banks
- Ease of wiring (can obviate use of lugs)
- Operator Safety
- Space saving
- Flexible mounting



Capacitor kVAr 415V, 3ph, 50Hz	Built-in aux. contacts	Type®	Unit LP ₹	Built-in aux. contacts	Type®	Unit LP ₹	Std. pkg. (nos.)
5 kvar NEW	1 NO	3TS2110-0A..5-8K†	2195.-				
7 kvar	1 NO	3TS1110-0A..5-8K†	2415.-				
10 kvar NEW	–	3TS2200-0A..5-8K†	2620.-	1NO+1NC	3TS2211-0A..5-8K	3005.-	
12.5 kvar	–	3TS1200-0A..5-8K†	2685.-	1NO+1NC	3TS1211-0A..5-8K	3070.-	1
16 kvar	–	3TS1300-0A..5-8K†	3690.-	1NO+1NC	3TS1311-0A..5-8K	4070.-	1
20 kvar	–	3TS1400-0A..5-8K†	4155.-	1NO+1NC	3TS1411-0A..5-8K	4530.-	1
25 kvar	–	3TS1500-0A..5-8K†	4805.-	1NO+1NC	3TS1511-0A..5-8K	5190.-	1
30 kvar NEW	–	3TS2500-0A..5-8K†	7480.-	1NO+1NC	3TS2511-0A..5-8K	7865.-	1
40 kvar NEW	2 NO + 2 NC	3TS2722-0A..5-8K	12700.-				
50 kvar	2 NO + 2 NC	3TS1722-0A..5-8K	14865.-				

† Facility to add one contact block of 1NO / 1NC

@ AC 50Hz coil code - Please enter coil codes from table below

For 3TS contactors			
Code	F0	P0	R0
Coil voltage (V)	110	230	415

Auxiliary contact blocks

For contactor	Description	Type	Unit LP ₹	Std. pkg. (nos.)
3TS1110-3TS1500	1NO	■ 3TX4010-2A	200.-	10
	1NC	■ 3TX4001-2A	200.-	10

3MT7 Capacitor Duty Contactors NEW

Capacitor kVar 440V AC, 3Ph, 50Hz	Built-in aux. contacts	Type	Unit LP ₹	Std. pkg. (nos.)
60kVAr	1NO+2NC	3MT70060JA126A..	15950.-	1
80kVAr	1NO+2NC	3MT70080JA126A..	19580.-	1
100kVAr	1NO+2NC	3MT70100JA126A..	20350.-	1

Please add coil code from adjacent table

Note: For SIRIUS 3RT26 Capacitor Duty Contactors - Please contact Siemens

Note: Please contact your nearest Siemens sales office for 3TS and 3MT7 capacitor duty contactor spares.

Coil 50/60Hz for 60 kvar contactor					
Coil Code	C2	G2	N2	P2	R2
Voltage	24V AC	110V AC	■ 220V AC	■ 240V AC	415V AC

Coil 50Hz for 80 & 100 kvar contactors				
Coil Code	F0	M0	U0	V0
Voltage	110V AC	■ 220V AC	■ 240V AC	415V AC



Automatic Power Factor Correction Relay (APFC relay)

Features

- Easy accessibility of parameters
- Universal control supply—optimizing the no of variants
- Automatic/ Linear/ rotational switching modes of banks
- Selectable 1A/ 5A current input
- LCD version with RS485 Communication MODBUS RTU Protocol
- Confirms to IEC60947-5-1, carry CE and RoHS Compliant



for more info scan QR code



7UG0572-1GT20

Description	Type	Unit LP ₹	Std. pkg. (nos.)
Automatic Power factor correction relay (APFC relay)	8 Stage with LCD display	7UG0571-1FT20	19610.-
	12 Stage with LCD display	7UG0572-1GT20	21000.-
	12 stage with LED display	7UG0572-1GT21	12010.-

* LP - List Price



Siemens Reyrolle Protection Relays

Relays for every application

Applications

- Feeder Protection
- Motor Protection
- Transformer Protection

Features

- Non Drawout / Drawout variants
- Programmable Tri-color LED's
- Communication: MODBUS RTU / IEC 103 and optional IEC 61850
- 1000 events / 10 disturbance records
- Programmable logic editor
- Easy Parameterization & Monitoring with ReyDisp Software

www.siemens.com/Reyrolle

SIEMENS

Portfolio Overview

Non-Directional
Fixed



7SR1002 / 3

Directional



7SR1004

Non-Directional
Drawout



7SR11

Directional



7SR12

Non-Directional | Fixed



7SR105

Directional | Drawout



7SR17

Directional | Drawout



7SR242

Check synchronizing



7SR157



Feeder Protection

Motor Protection

Transformer Protection

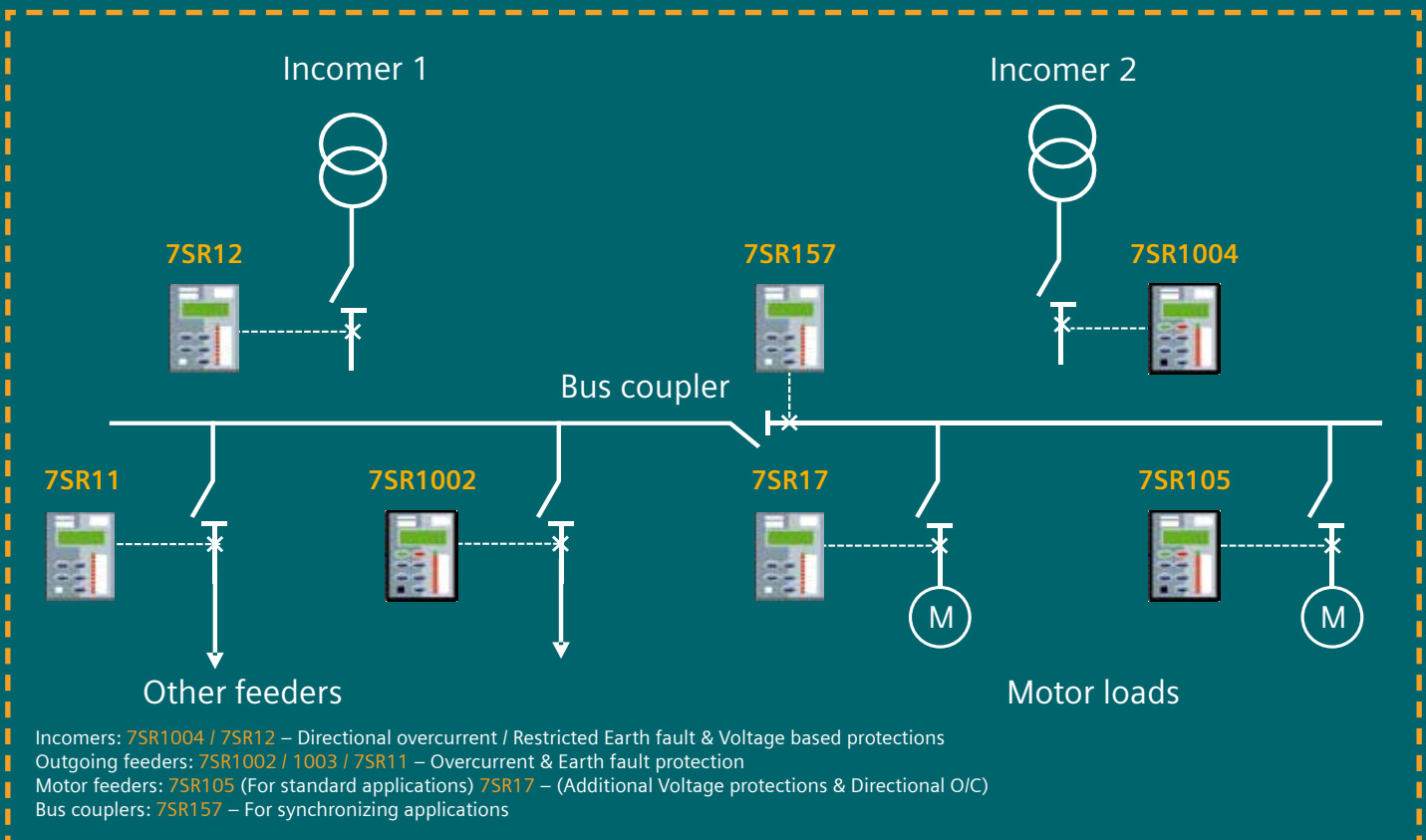

7SR Numerical Relays

	Description	Type *	Unit LP ₹
Feeder Protection	Non Drawout Non Directional overcurrent relay 6 BI 6 BOs Measuring current input: 1/5A Auxiliary voltage: 60 to 240V AC/DC BI Threshold: 44V AC/DC Communication: Front USB, RS485 supporting IEC 60870-5-103 /Modbus RTU/DNP 3.0 Protection Functions: 46BC, 46NPS, 49, 50, 51, 50G/N, 51G/N, 50/51 SEF, 74T/CCS, 81THD, 86	7SR1003-1LA20-2CA0	63890.-
	Non Drawout Directional overcurrent relay 9 BI 6 BOs Measuring current input: 1/5A with SEF input Auxiliary voltage: 60 to 240V AC/DC BI Threshold: 88V AC/DC Communication: Front USB, RS485 supporting IEC 60870-5-103 /Modbus RTU/DNP 3.0 Protection Functions: 27/59, 32, 32S, 37, 46BC, 46NPS, 47NPS, 49, 50BF, 51V, 55, 59N, 60CTS, 60VTS, 64H, 67/50, 50SEF, 51G/N, 51SEF, 74T/CCS, 81U/O	7SR1004-4KA20-2CA0	110695.-
	Drawout Non Directional overcurrent relay 6 BI 8 BOs Measuring current input: 1/5A Auxiliary voltage: 100 to 230V AC/24 -250VDC BI Threshold: 19VDC Communication: Front USB, RS485 supporting IEC 60870-5-103 /Modbus RTU/DNP 3.0 Protection Functions: 46BC, 46NPS, 49, 50, 50AFD, 50BF, 51, 50G/N, 51G/N, 64H, 74T/CCS, 86	7SR1103-1MA12-1CA0	107865.-
	Drawout Directional overcurrent relay 6 BI 8 BOs Measuring current input: 1/5A Auxiliary voltage: 100 to 230V AC/24 -250VDC BI Threshold: 19VDC Communication: Front USB, RS485 supporting IEC 60870-5-103 /Modbus RTU/DNP 3.0 Protection Functions: 27, 59, 32, 32S, 37, 46BC, 46NPS, 47, 49, 50, 50AFD, 50BF, 51, 50N, 51N, 51V, 55, 59N, 60CTS, 64H, 67, 74T/CCS, 81U/O, 86	7SR1206-2MA12-1CA0	120315.-
Motor Protection	Non Drawout Motor Protection Relay 6 BI 6 BOs Measuring current input: 1/5A Auxiliary voltage: 60 to 240V AC/DC BI Threshold: 44V AC/DC Communication: Front USB, RS485 supporting IEC 60870-5-103 /Modbus RTU/DNP 3.0 Protection Functions: 14, 37, 46, 46PhRev, 48/66, 49, 50/51, 50G/N, 51G/N, 50BCL, 50BF, 74T/CCS, 81B	7SR1053-2LA21-2EA0	92735.-
	Drawout Motor Protection Relay 3 BI 5 BOs Measuring current input: 1/5A with SEF input Auxiliary voltage: 100 to 230V AC/24 -250VDC BI Threshold: 19VDC Communication: Front USB, RS485 supporting IEC 60870-5-103 /Modbus RTU/DNP 3.0 Protection Functions: 14, 37, 46, 46PhRev, 48/66, 49, 50, 51, 50G/N, 51G/N, 50BF, 50BCL, 60CTS, 74T/CCS, 81B	7SR1702-3MA12-1CA0	143125.-
	Drawout Motor Protection Relay 6 BI 8 BOs 4CT 3VT Measuring current input: 1/5A with SEF input Auxiliary voltage: 100 to 230V AC/24 -250VDC BI Threshold: 19VDC Communication: Front USB, RS485 supporting IEC 60870-5-103 /Modbus RTU/DNP 3.0 Protection Functions: 14, 37, 46, 46PhRev, 48/66, 49, 50, 51, 50G/N, 51G/N, 50BF, 50BCL, 60CTS, 74T/CCS, 81B, 27/59, 32/55, 47, 60CTS, 60VTS, 67/50, 67/51, 67G/N, 81	7SR1706-4MA12-1CA0	152670.-
Transformer Protection	Drawout Transformer Protection Relay 9 BI 6 BOs 8CT 1VT Measuring current input: 1/5A Auxiliary voltage: 100 to 230V AC/24 -250VDC BI Threshold: 19VDC Communication: Front USB, RS485 supporting IEC 60870-5-103 /Modbus RTU/DNP 3.0 Protection Functions: 81HBL2, 81HBL5, 87BD, 87HS, 49, 50, 51, 50G/N, 51G/N, 50BF, 64H, 74TCS/CCS, 37/37G, 46BC, 46NPS	7SR2422-2MA12-0BA0	318615.-

* For more options on control voltage, BI/BOs, Communication protocols or protection functions please consult nearest Siemens Office

7PJ Auxiliary & Trip Relays

	Description	Type	Unit LP ₹
Aux Relays	Auxiliary relay Single Element with self reset contacts with flag, 110V DC, 3NO+2CO, Low burden	7PJ1111-6DA20-0AA0	8200.-
	Auxiliary relay Single Element with self reset contacts with flag, 220V DC, 3NO+2CO, Low burden	7PJ1111-7DA20-0AA0	8200.-
	Auxiliary relay Single Element with self reset contacts without flag, 110V DC, 3NO+2CO, Low burden	7PJ1114-6DA20-0AA0	8200.-
	Auxiliary relay Single Element with self reset contacts without flag, 220V DC, 3NO+2CO, Low burden	7PJ1114-7DA20-0AA0	8200.-
	Auxiliary relay Three Element, hand reset with flag, 110V DC, 2NO, Low burden	7PJ1132-6CA00-0AA0	16475.-
	Auxiliary relay Three Element, hand reset with flag, 220V DC, 2NO, Low burden	7PJ1132-7CA00-0AA0	16475.-
Trip Relays	Trip relay with hand reset contacts with flag, DC 110V, 4NO+1NC, high burden	7PJ1212-6EB01-0AA0	8200.-
	Trip relay with hand reset contacts with flag, DC 220V, 4NO+1NC, high burden	7PJ1212-7EB01-0AA0	8200.-
	TCS relay, 2CO, SR, Aux 24-240VAC/DC, BI 24-240VDC	7PJ1321-5AA21-0AA0	15045.-

7XJ Arc Protection systems



For more information on Siemens Numerical Relays



* LP - List Price

Std Pkg = 1unit

Fuseless selection Iq = 50 kA, IS/IEC:60947-4-1 (3VM with 3RT & 3RU)

Suitable for IE2 motors

- The selection is valid only for complete Siemens combinations i.e MCCB + Contactor + Birelay mentioned below.
- In case this combination is changed to accommodate another brand / rating of MCCB / contactor / birelay, it shall be the responsibility of the person making such a change to assure the coordination.
- Selection is for normal starting conditions with starting time ≤ 6 seconds. (For heavy starting applications e.g. ID/FD fans, reciprocating compressor, ball mills etc., please consult Siemens.)
- Magnetic setting of Circuit breaker to be done as per starting current of Motor
- For charts with 3VM MCCB for ratings below 75kW, please consult Siemens.
- **Recommended selection.**

Direct-on-line feeder

kW 415V, 3ph, 50/60 Hz	Rated current IL (A)	Breaking Capacity Iq	Circuit Breaker		Contactor		Bi-relay	
			MCCB	Rated current In (A)	Type	Amp	Type	Range (A)
75	134	50kA	3VM1216-5MH32-0AA0	160	3RT1055	150	3RU2156-5DB10-8K	110 - 160
90	160	50kA	3VM1220-5MH32-0AA0	200	3RT1056	185	3RU2156-5EB10-8K	140 - 200
110	190	50kA	3VM1325-5MH32-0AA0	250	3RT1064	225	3RU2166-5FB10-8K	180 - 250
132	228	50kA	3VM1325-5MH32-0AA0	250	3RT1065	265	3RU2166-5GB10-8K	220 - 320
160	269	50kA	3VM1332-5MH32-0AA0	320	3RT1066	300	3RU2166-5GB10-8K	220 - 320
200	350	50kA	3VM1440-5MH32-0AA0	400	3RT1075	400	3RU2176-5HB10-8K	280 - 400
250	430	50kA	3VM1450-5MH32-0AA0	500	3RT1076	500	3RU2176-5JB10-8K	350 - 500

Star-Delta feeder

kW 415V, 3ph, 50/60 Hz	Rated current IL (A)	Phase Current Iph (A)	Breaking Capacity Iq	Circuit Breaker		Contactor (Line/Delta)		Contactor (Star)		Bi-relay	
				MCCB	Rated current In (A)	Type	Amp	Type	Amp	Type	Range (A)
75	131	75.6	50kA	3VM1216-5MH32-0AA0	160	3RT1055	150	3RT2038	80	3RU2146-4LB0	70 - 90
90	156	90.1	50kA	3VM1220-5MH32-0AA0	200	3RT1056	185	3RT2038	80	3RU2146-4MB0	80 - 100
110	189	109	50kA	3VM1325-5MH32-0AA0	250	3RT1064	225	3RT1054	115	3RU2156-5CB10-8K	90 - 125
132	227	131.1	50kA	3VM1325-5MH32-0AA0	250	3RT1065	265	3RT1054	115	3RU2156-5DB10-8K	110 - 160
160	271	156.5	50kA	3VM1332-5MH32-0AA0	320	3RT1066	300	3RT1054	115	3RU2156-5EB10-8K	140 - 200
200	339	195.7	50kA	3VM1440-5MH32-0AA0	400	3RT1076	500	3RT1056	185	3RU2166-5FB10-8K	180 - 250
250	398	229.8	50kA	3VM1450-5MH32-0AA0	500	3RT1076	500	3RT1065	265	3RU2166-5GB10-8K	220 - 320

Note: For ratings below 75kW, with SCPD 3RV MPCB, please refer to LV SGR - Motor Control Products Price list page no. 97/98 or consult nearest Siemens Office.

Fuseless selection Iq = 50 kA, IS/IEC:60947-4-1 (3VA with 3RT & 3RU)

Suitable for IE3 motors

- The selection is valid only for complete Siemens combinations i.e MCCB + Contactor + Bi-relay mentioned below.
- In case this combination is changed to accommodate another brand / rating of MCCB / contactor / bi-relay, it shall be the responsibility of the person making such a change to assure the coordination.
- Selection is for normal starting conditions with starting time ≤ 6 seconds. (For heavy starting applications e.g. ID/FD fans, reciprocating compressor, ball mills etc., please consult Siemens.)
- Ratio of starting current to rated current: In accordance to IS12615:2018
- Magnetic setting of Circuit breaker to be done as per starting current of Motor
- For charts with 3VA MCCB for ratings below 37kW, please consult Siemens.
- **Recommended selection.**

Direct-on-line feeder

kW 415V, 3ph, 50/60 Hz	Rated current IL (A)	Breaking Capacity Iq	Circuit Breaker		Contactor		Bi-relay	
			MCCB	Rated current In (A)	Type	Rating (A)	Type	Range (A)
37	64	50kA	3VA1180-5MH32-0AA0	80	3RT2038	80	3RU2136-4KB0	62...73
45	77	50kA	3VA1180-5MH32-0AA0	80	3RT2047	110	3RU2146-4LB0	70...90
55	95	50kA	3VA1112-5MH32-0AA0	125	3RT1055	150	3RU2156-5CB10-8K	90...125
75	129	50kA	3VA1216-5MH32-0AA0	160	3RT1055	150	3RU2156-5DB10-8K	110-160
90	151	50kA	3VA1220-5MH32-0AA0	200	3RT1056	185	3RU2156-5EB10-8K	140-200
110	186	50kA	3VA1325-5MH32-0AA0	250	3RT1064	225	3RU2156-5EB10-8K	140-200
132	221	50kA	3VA1332-5MH32-0AA0	320	3RT1065	265	3RU2166-5FB10-8K	180-250
160	267	50kA	3VA1440-5MH32-0AA0	400	3RT1066	300	3RU2166-5GB10-8K	220-320
200	332	50kA	3VA1450-5MH32-0AA0	500	3RT1076	500	3RU2176-5HB10-8K	280-400
250	420	50kA	3VA1450-5MH32-0AA0	500	3RT1076	500	3RU2176-5JB10-8K	350-500

Star-Delta feeder

kW 415V, 3ph, 50/60 Hz	Rated current IL (A)	Phase Current Iph (A)	Breaking Capacity Iq	Circuit Breaker		Contactor (Line/ Delta)		Contactor (Star)		Bi-relay	
				MCCB	Rated current In (A)	Type	Rating (A)	Type	Rating (A)	Type	Range (A)
37	64	37	50kA	3VA1180-5MH32-0AA0	80	3RT2038	80	3RT2035	40	3RU2136-4GB0	36...45
45	77	44.5	50kA	3VA1180-5MH32-0AA0	80	3RT2038	80	3RT2035	40	3RU2136-4QB0	47...57
55	95	54.9	50kA	3VA1112-5MH32-0AA0	125	3RT2047	110	3RT2035	40	3RU2136-4KB0	57...75
75	129	74.5	50kA	3VA1216-5MH32-0AA0	160	3RT1055	150	3RT2037	65	3RU2156-5BB10-8K	70-100
90	151	87.2	50kA	3VA1216-5MH32-0AA0	160	3RT1056	185	3RT2037	65	3RU2156-5BB10-8K	70-100
110	186	107.4	50kA	3VA1220-5MH32-0AA0	200	3RT1064	225	3RT1054	115	3RU2156-5CB10-8K	90-125
132	221	127.6	50kA	3VA1325-5MH32-0AA0	250	3RT1065	265	3RT1056	185	3RU2156-5DB10-8K	110-160
160	267	154.2	50kA	3VA1332-5MH32-0AA0	320	3RT1066	300	3RT1056	185	3RU2156-5EB10-8K	140-200
200	332	191.7	50kA	3VA1440-5MH32-0AA0	400	3RT1076	500	3RT1065	265	3RU2166-5FB10-8K	180-250
250	420	242.5	50kA	3VA1450-5MH32-0AA0	500	3RT1076	500	3RT1066	300	3RU2166-5GB10-8K	220-320

Note: For ratings below 37kW, with SCPD 3RV MPCB, please refer to LV SGR - Motor Control Products Price list page no. 97/98 or consult nearest Siemens Office.

Fuse protected selection type 2, Iq = 50kA, IS/IEC:60947-4-1 (3KL with 3RT & 3RU)

Suitable for IE2 motors

- The selection is valid only for complete Siemens combinations i.e. SDF + DIN Fuse + Contactor + Bi-Relay (+ timer).
- In case this combination is changed to accommodate another brand/rating of SDF/DIN Fuse/Contactor/BMR, it shall be the responsibility of the person making such a change to assure type 2 performance.
- Selection is for normal starting conditions (class 10 feeder). (For heavy starting applications e.g. ID/FD fans, reciprocating compressor, ball mills etc., please consult Siemens.)
- The electronic star-delta timer type 3RP should be used in star-delta feeders.
- SDF: Switch Disconnecter Fuse. All fuses are DIN HRC type.
- Tested Type 2 combinations
- Low LCC = Low Life Cycle Cost

Direct-on-line feeder, for Low LCC

SL Motor		SDF		Fuse		Contactor		Bi-Relay	
kW 415V, 3ph, 50/60 Hz	I _L Amps	Type	Amp	Type	Amps	Type	Rating Amps	Type	Set-Range Amp
0.37	1.1	3KL811	20	3NA78040RC	4	3RT2015	7	3RU2116-0KB0	0.9 ... 1.25
0.55	1.4	3KL811	20	3NA78040RC	4	3RT2015	7	3RU2116-1AB0	1.1 ... 1.6
0.75	1.7	3KL811	20	3NA78010RC	6	3RT2015	7	3RU2116-1BB0	1.4 ... 2
1.1	2.4	3KL811	20	3NA78010RC	6	3RT2015	7	3RU2116-1DB0	2.2 ... 3.2
1.5	3.2	3KL811	20	3NA78030RC	10	3RT2015	7	3RU2116-1EB0	2.8 ... 4
2.2	4.8	3KL811	20	3NA78050RC	16	3RT2015	7	3RU2116-1GB0	4.5 ... 6.3
3.7	7.4	3KL811	20	3NA78070RC	20	3RT2024	12	3RU2126-1JB0	7...10
5.5	11.2	3KL812	32	3NA78100RC	25	3RT2024	12	3RU2126-1KB0	9 ... 12.5
7.5	15	3KL812	32	3NA78120RC	32	3RT2025	17	3RU2126-4AB0	11 ...16
11	21	3KL815	63	3NA78200RC	50	3RT2027	32	3RU2126-4DB0	20 ... 25
15	28	3KL815	63	3NA78220RC	63	3RT2035	40	3RU2136-4EB0	22 ... 32
18.5	34	3KL821	100	3NA78240RC	80	3RT2035	40	3RU2136-4FB0	28 ... 40
22	40	3KL821	100	3NA78240RC	80	3RT2036	50	3RU2136-4GB0	36 ... 45
30	57	3KL821	100	3NA78300RC	100	3RT2037	65	3RU2136-4QB0	47 ... 57
37	64	3KL822	125	3NA78320RC	125	3RT2038	80	3RU2136-4KB0	62 ... 73
45	77	3KL822	125	3NA78320RC	125	3RT2046	95	3RU2136-4RB0	70 ... 80
55	101	3KL823	160	3NA78360RC	160	3RT1054	115	3RU2156-5CB10-8K	90 ... 125
75	134	3KL831	200	3NA71400RC	200	3RT1055	150	3RU2156-5DB10-8K	110 ... 160
90	160	3KL832	250	3NA71440RC	250	3RT1056	185	3RU2156-5EB10-8K	140 ... 200
110	190	3KL832	250	3NA71440RC	250	3RT1064	225	3RU2166-5FB10-8K	180 ... 250
132	228	3KL833	315	3NA72520RC	315	3RT1065	265	3RU2166-5FB10-8K	180 ... 250
160	269	3KL834	400	3NA72600RC	400	3RT1066	300	3RU2166-5GB10-8K	220 ... 320
200	350	3KL841	500	3NA33650RC	500	3RT1075	400	3RU2176-5HB10-8K	280 ... 400
250	430	3KL841	500	3NA33650RC	500	3RT1076	500	3RU2176-5JB10-8K	350 ... 500

Star-Delta feeder, for Low LCC

SL Motor			SDF		HRC Fuses		Contactor Line/Delta		Contactor Star		Bi-Relay		Timer
kW 415V, 3ph, 50/60 Hz	I _L Amps	I _{Ph} Amps	Type	Rating Amps	Type	Rating Amps	Type	Rating Amps	Type	Rating Amps	Type	Set-Range Amp	Type
4	7.8	4.5	3KL811	20	3NA78030RC	10	3RT2023	9	3RT2023	9	3RU2126-1FB0	3.5 ... 5	3RP15
5.5	11.2	6.5	3KL811	20	3NA78050RC	16	3RT2023	9	3RT2023	9	3RU2126-1HB0	5.5 ... 8	3RP15
7.5	15	9.2	3KL811	20	3NA78070RC	20	3RT2024	12	3RT2023	9	3RU2126-1JB0	7 ... 10	3RP15
11	21	12	3KL812	32	3NA78100RC	25	3RT2025	17	3RT2023	9	3RU2126-1KB0	9 ... 12.5	3RP15
15	28	16.2	3KL812	32	3NA78120RC	32	3RT2026	25	3RT2025	17	3RU2126-4BB0	14 ... 20	3RP15
18.5	34	19.7	3KL815	63	3NA78200RC	50	3RT2027	32	3RT2026	25	3RU2126-4CB0	17 ... 22	3RP15
22	40	23.2	3KL815	63	3NA78200RC	63	3RT2035	40	3RT2026	25	3RU2136-4DB0	18 ... 25	3RP15
30	57	30.6	3KL821	100	3NA78220RC	80	3RT2035	40	3RT2026	25	3RU2136-4EB0	22 ... 32	3RP15
37	64	37.5	3KL821	100	3NA78240RC	80	3RT2035	40	3RT2027	32	3RU2136-4FB0	28 ... 40	3RP15
45	77	45	3KL821	100	3NA78300RC	100	3RT2037	65	3RT2028	40	3RU2136-4HB0	40 ... 50	3RP15
55	101	55.4	3KL821	100	3NA78300RC	100	3RT2037	65	3RT2035	40	3RU2136-4JB0	54 ... 65	3RP15
75	134	75.6	3KL823	160	3NA78360RC	160	3RT2038	80	3RT2037	65	3RU2136-4RB0	70 ... 80	3RP15
90	156	90	3KL823	160	3NA78360RC	160	3RT2046	95	3RT2038	80	3RU2146-4LB0	70 ... 90	3RP15
110	190	113	3KL831	200	3NA71400RC	200	3RT1054	115	3RT1054	115	3RU2156-5CB10-8K	90 ... 125	3RP15
132	228	133	3KL832	250	3NA71440RC	250	3RT1055	150	3RT1054	115	3RU2156-5DB10-8K	110 ... 160	3RP15
160	269	162	3KL833	315	3NA72520RC	315	3RT1056	185	3RT1054	115	3RU2156-5EB10-8K	140 ... 200	3RP15
200	350	202	3KL834	400	3NA72600RC	400	3RT1064	225	3RT1056	185	3RU2166-5FB10-8K	180 ... 250	3RP15
250	430	248	3KL841	500	3NA33650RC	500	3RT1075	400	3RT1065	265	3RU2166-5GB10-8K	220 ... 320	3RP15

Fuse protected selection type 2, Iq = 50kA, IS/IEC:60947-4-1 (3KL with 3TF & 3UA)

Suitable for IE2 motors

- The selection is valid only for complete Siemens combinations i.e. SDF + DIN Fuse + Contactor + Bi-Relay (+ timer).
- In case this combination is changed to accommodate another brand/rating of SDF/DIN Fuse/Contactor/BMR, it shall be the responsibility of the person making such a change to assure type 2 performance.
- Selection is for normal starting conditions with starting time ≤ 6 seconds. (For heavy starting applications e.g. ID/FD fans, reciprocating compressor, ball mills etc., please consult Siemens.)
- At 60°C service temperature the bi-relay has to be derated. The bi-relay can be used upto the maximum current setting indicated. For example - A bi-relay with setting 32-50A, at 60°C can be used only upto 47A. This however does not mean that at 60°C, the 50A setting corresponds to 47A. It means that, the bi-relay should not be set beyond 47A.
- The electronic star-delta timer type 3RP should be used in star-delta feeders.
- SDF: Switch Disconnector Fuse. All fuses are DIN HRC type.
- Tested Type 2 combinations
- Low LCC = Low Life Cycle Cost

Direct-on-line feeder, for Low LCC

SL Motor	Motor	SDF		HRC Fuse		Contactor		Bi-Relay		Bi-Relay	
kW 415V, 3ph, 50Hz	I _L Amp	Type	Rating	Type	Amp	Type	Amp	Type (50°C)	Set-Range Amp	Type (60°C)	Available Set-Range Amp
0.37	1	3KL811	20	3NA78040RC	4	3TF30	9	3UA5000-0K	0.8 - 1.25	3UA5000-0K	0.8 - 1.17
0.55	1.3	3KL811	20	3NA78040RC	4	3TF30	9	3UA5000-1A	1 - 1.6	3UA5000-1A	1 - 1.5
0.75	1.9	3KL811	20	3NA78010RC	6	3TF30	9	3UA5000-1B	1.25 - 2	3UA5000-1B	1.6 - 2.3
1.1	2.6	3KL811	20	3NA78010RC	6	3TF30	9	3UA5000-1D	2 - 3.2	3UA5000-1D	2 - 3
1.5	3.7	3KL811	20	3NA78030RC	10	3TF30	9	3UA5000-1E	2.5 - 4	3UA5000-1E	2.5 - 3.7
2.2	4.8	3KL811	20	3NA78050RC	16	3TF30	9	3UA5000-1F	3.2 - 5	3UA5000-1G	4 - 5.9
3.7	7.8	3KL811	20	3NA78070RC	20	3TF30	9	3UA5000-1H	5 - 8	3UA5000-1J	6.3 - 9.4
5.5	11.2	3KL812	32	3NA78100RC	25	3TF31	12	3UA5000-1K	8 - 12.5	3UA5000-1K	8 - 11.7
7.5	16	3KL812	32	3NA78120RC	32	3TF32	16	3UA5200-2A	10 - 16	3UA5200-2B	12.5 - 18.7
9.3	19	3KL815	63	3NA78200RC	50	3TF34	32	3UA5500-2B	12.5 - 20	3UA5500-2C	16 - 23.4
11	20.8	3KL815	63	3NA78200RC	50	3TF34	32	3UA5500-2C	16 - 25	3UA5500-2C	16 - 23.4
15	28	3KL815	63	3NA78220RC	63	3TF34	32	3UA5500-2D	20 - 32	3UA5500-2D	20 - 30
18.5	34	3KL815	63	3NA78220RC	63	3TF35	38	3UA5500-2Q	25 - 36	3UA5500-2R	32 - 37.4
22	40	3KL817	100	3NA78240RC	80	3TF46	45	3UA5800-2FZ1	32 - 50	3UA5800-2FZ1	32 - 47
30	53	3KL817	100	3NA78300RC	100	3TF47	63	3UA5800-2TZ1	40 - 57	3UA5800-2PZ1	50 - 59
37	65	3KL822	125	3NA78320RC	125	3TF477	70	3UA5800-2VZ2	57 - 70	3UA5800-2VZ2	57 - 65.5
45	78	3KL822	125	3NA78320RC	125	3TF49	85	3UA5800-8YZ1	70 - 95	3UA5800-8YZ1	70 - 88.9
55	96	3KL823	160	3NA78360RC	160	3TF50	110	3UA5830-5C	85 - 105	3UA5830-5C	85 - 98.2
75	131	3KL831	200	3NA71400RC	200	3TF51	140	3UA6230-5A	85 - 135	3UA6230-5B	115 - 168
90	156	3KL832	250	3NA71440RC	250	3TF52	170	3UA6230-5B	115 - 180	3UA6230-5B	115 - 168
110	189	3KL832	250	3NA71440RC	250	3TF53	205	3UA6230-5C	160 - 250	3UA6230-5C	160 - 234
132	227	3KL833	315	3NA72520RC	315	3TF54	250	3UA6230-5C	160 - 250	3UA6230-5C	160 - 234
160	271	3KL834	400	3NA72600RC	400	3TF55	300	3UA6230-5D	200 - 320	3UA6230-5D	200 - 299
200	339	3KL841	500	3NA33650RC	500	3TF56	400	3UA6230-5E	250 - 400	3UA6230-5E	250 - 374
250	398	3KL841	500	3NA33650RC	500	3TF57	475	3UA6830-5F	320 - 500	3UA6830-5F	320 - 468

Star-Delta feeder, for Low LCC

SL Motor	Motor		SDF		HRC Fuses		Contactor Line/Delta		Contactor Star		Bi-Relay		Bi-Relay		Timer
kW 415V, 3ph, 50Hz	I _L Amp.	I _{ph} Amp	Type	Rating	Type	Amp	Type	Amp	Type	Amp	Type (50°C)	Set-Range Amp	Type (60°C)	Available Set-Range Amp	Type
3.7	7.8	4.5	3KL811	20	3NA78030RC	10	3TF30	9	3TF30	9	3UA5000-1F	3.2-5	3UA5000-1F	3.2-4.7	3RP15
5.5	11.2	6.5	3KL811	20	3NA78050RC	16	3TF30	9	3TF30	9	3UA5000-1H	5-8	3UA5000-1H	5-7.5	3RP15
7.5	16	9.2	3KL811	20	3NA78070RC	20	3TF31	12	3TF30	9	3UA5000-1J	6.3-10	3UA5000-1J	6.3-9.4	3RP15
9.3	19	11	3KL812	32	3NA78100RC	25	3TF31	12	3TF30	9	3UA5000-1K	8-12.5	3UA5000-1K	8-11.7	3RP15
11	20.8	12	3KL812	32	3NA78100RC	25	3TF31	12	3TF30	9	3UA5000-1K	8-12.5	3UA5000-2S	10-13.6	3RP15
15	28	16.2	3KL812	32	3NA78120RC	32	3TF33	22	3TF32	16	3UA5200-2B	12.5-20	3UA5200-2B	12.5-18.7	3RP15
18.5	34	19.7	3KL815	63	3NA78200RC	50	3TF34	32	3TF34	32	3UA5500-2B	12.5-20	3UA5500-2C	16-23.4	3RP15
22	40	23.2	3KL815	63	3NA78200RC	50	3TF34	32	3TF34	32	3UA5500-2C	16-25	3UA5500-2D	22-30	3RP15
30	53	30.6	3KL815	63	3NA78220RC	63	3TF34	32	3TF34	32	3UA5500-2D	20-32	3UA5500-2Q	25-33.7	3RP15
37	65	37.5	3KL817	100	3NA78240RC	80	3TF35	38	3TF34	32	3UA5500-2R	32-40	3UA5500-8M	36-45	3RP15
45	78	45	3KL817	100	3NA78300RC	100	3TF46	45	3TF34	32	3UA5800-2FZ1	32-50	3UA5800-2FZ1	32-47	3RP15
55	96	55.4	3KL817	100	3NA78300RC	100	3TF47	63	3TF34	32	3UA5800-2TZ1	40-57	3UA5800-2PZ1	50-59	3RP15
75	131	75.6	3KL823	160	3NA78360RC	160	3TF49	85	3TF47	63	3UA5800-8YZ1	70-95	3UA5800-8YZ1	70-88.9	3RP15
90	156	90.1	3KL823	160	3NA78360RC	160	3TF50	110	3TF47	63	3UA5830-5B	70-95	3UA5830-5C	85-98.2	3RP15
110	189	109	3KL831	200	3NA71400RC	200	3TF50	110	3TF50	110	3UA5830-5D	95-120	3UA5830-5D	95-112	3RP15
132	227	131.1	3KL832	250	3NA71440RC	250	3TF51	140	3TF50	110	3UA6230-5B	115-180	3UA6230-5B	115-168	3RP15
160	271	156.5	3KL833	315	3NA72520RC	315	3TF52	170	3TF50	110	3UA6230-5B	115-180	3UA6230-5B	115-168	3RP15
200	339	195.7	3KL834	400	3NA72600RC	400	3TF54	250	3TF52	170	3UA6230-5C	160-250	3UA6230-5C	160-234	3RP15
250	398	229.8	3KL841	500	3NA72600RC	400	3TF54	250	3TF54	250	3UA6230-5C	160-250	3UA6230-5D	200-299	3RP15

Type-2 Coordination Charts



IoT-Cloud apps and remote monitoring

→ "Cloud / apps"



Connectivity and on-premise monitoring

→ "Software / gateway"



Field devices and sensors

→ "Things"



SENTRON
Powermind



7KN Powercenter 3000



3WA / 3WL

3VA

7KM PAC3220

SENTRON Digitalization Solution

Intelligent power distribution management

Secure. Scalable. Customizable.

Turn your LV Panels into IoT enabled digital switchboards with benefits like:



On-site or cloud-based data visualization and analysis



Fulfill regulatory requirements (e.g., ISO 50001)



Energy transparency and efficiency without compromising security



Reduce unplanned downtime with condition monitoring

Siemens/SENTRON-Digitalization

MindSphere



Watts



SENTRON powermanager



SENTRON powerconfig



Adaptive web interface

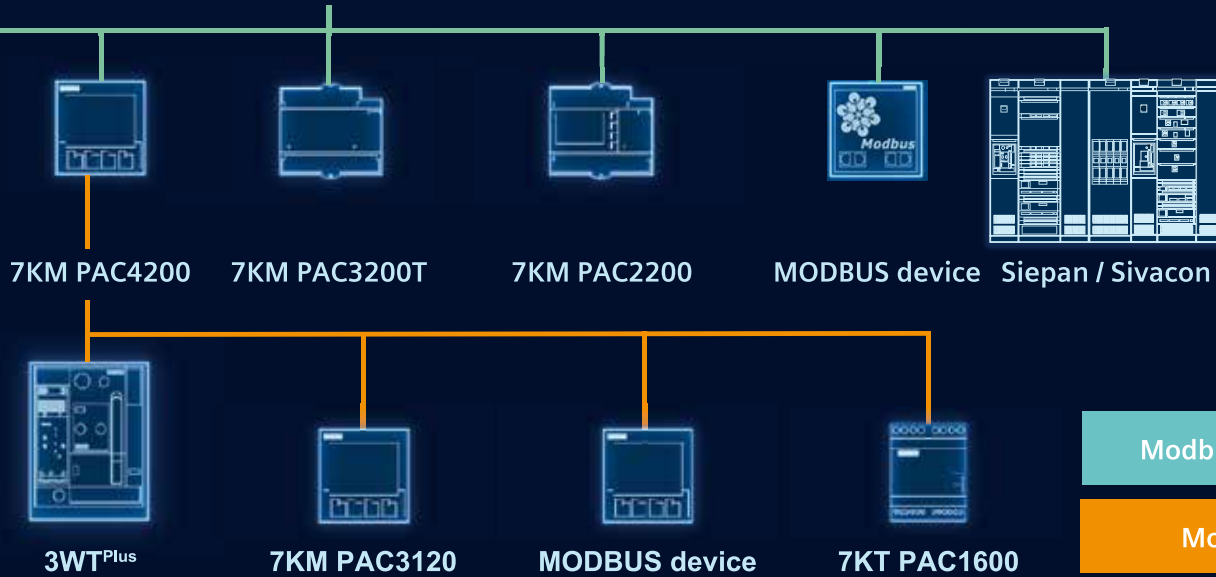

Scan to explore



SIEMENS



Energy management

Detection, transparency and control of energy flows

101 0
1 11101
0011011
10101
00101

Adaptability to Industry 4.0

Easy digitalization of "brownfield" projects

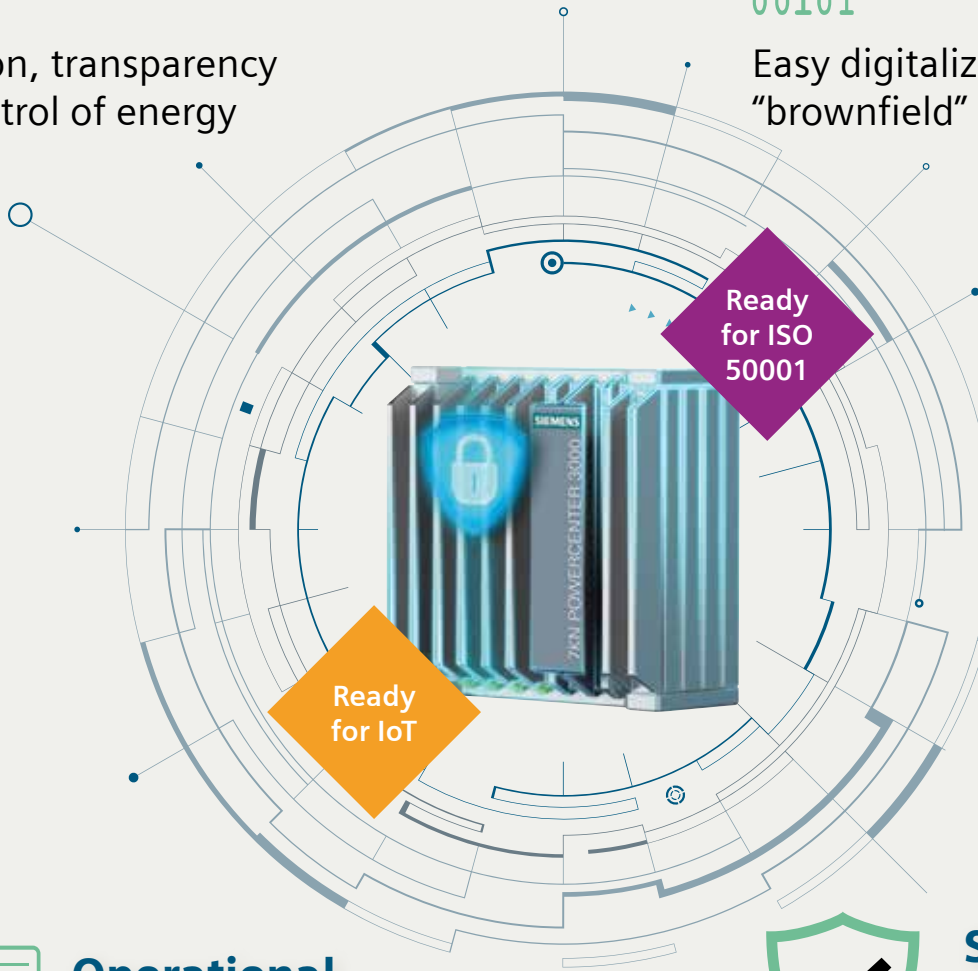

Operational flexibility

Choice of visualization via Web Interface, on premise or connect to Cloud



Safety through reliability

Identifying potential outages at an early stage enable preventing them

SENTRON Powercenter 3000

Gateway to the digitalization of low-voltage power distribution

Siemens/SENTRON-Digitalization

SIEMENS

Available till stocks last

7KM PAC3200 power monitoring device

Description	Type	Unit LP* ₹	Std. pkg. (nos.)
PAC 3200 with integrated ethernet port for MODBUS TCP Class 0.5s accuracy, screw terminals With AC/DC wide voltage power supply 95...240V AC ±10%, 50/60Hz, 110...340V DC ±10%	7KM2112-0BA00-3AA0	60190.-	1

Superswitch 3KL8

Switch Disconnecter fuse: 3KL8 3-pole with Isolable neutral (Open Execution)

Rated current I _e @690V 50Hz	SDF suitable for DIN type HRC fuses	Unit MRP* ₹	SDF suitable for BS type HRC fuses	Unit MRP* ₹	SDF suitable for Cylindrical type HRC fuses	Unit MRP* ₹	Std. pkg. (nos.)
20A	3KL8111-3TA00	3200.-	3KL8111-3TJ00	3100.-	3KL8111-3TC00	3150.-	1
32A	3KL8121-3TA00	3280.-	3KL8121-3TJ00	3205.-	3KL8121-3TC00	3250.-	1
63A	3KL8151-3TA00	4630.-	3KL8151-3TJ00	4480.-	3KL8151-3TC00	4520.-	1
100A	3KL8211-3TA00	9245.-	3KL8211-3TJ00	9070.-			1
125A	3KL8221-3TA00	12095.-	3KL8221-3TJ00	11935.-			1
160A [§]	3KL8231-3TA00	13195.-	3KL8231-3TJ00	13015.-			1
200A	3KL8311-3UA00	16860.-	3KL8311-3UJ00	16315.-			1
250A	3KL8321-3UA00	19825.-	3KL8321-3UJ00	20180.-			1
315A	3KL8331-3UA00	24510.-	3KL8331-3UJ00	23870.-			1
400A [§]	3KL8341-3UA00	29525.-	3KL8341-3UJ00	29970.-			1
500A	3KL8411-3UA00	46195.-	3KL8411-3UJ00	44430.-			1
630A	3KL8421-3UA00	47460.-	3KL8421-3UJ00	46035.-			1
800A [§]	3KL8431-3UA00	51410.-	3KL8431-3UJ00	49895.-			1

Notes:

3KL8/ 3KA8 is rated for 690V, 50Hz, AC23A Utilisation Category

§ AC23A @500V AC

All SDF Unit MRPs are without fuses

Unit MRP's are inclusive of front drive (Handle) kit, fuse cover, terminal cover, isolable neutral cover and phase barriers.

Accessories for 3KL8 / 3KA8: 3-pole with Isolable neutral (Open Execution)

Description	3KL81 11/21/51 3KA81 51	Unit MRP* ₹	3KL82 11/21/31 3KA82 11/21/31	Unit MRP* ₹	3KL83 11/21/31/41 3KA83 11/21/41/51	Unit MRP* ₹	3KL84 11/21/31 3KA84 3/4/5/6	Unit MRP* ₹	Std. pkg. (nos.)
Fuse Cover	3KX8150-0AC	390.-	3KX8230-0AC	560.-	3KX8340-0AC	815.-	3KX8430-0AC	1155.-	1
Terminal Cover (1 set)	-	-	3KX8231-0AC	470.-	3KX8341-0AC	895.-	3KX8431-0AC	1045.-	1
Isolable Neutral cover	-	-	3KX8232-0AC	235.-	3KX8342-0AC	385.-	3KX8432-0AC	470.-	1
Phase Barrier ^{§§}	3KX8153-0AC	160.-	3KX8233-0AC	160.-	3KX8343-0AC	230.-	3KX8433-0AC	295.-	1

§§ For phase barriers of BS type switches contact nearest Siemens sales office.

* LP - List Price

* MRP - Maximum Retail Price

Discontinued products

3KC Automatic Transfer Controller

Description	Type
ATC 5300	3KC9000-8TL30

Control switches 3ST

Switch	Description	Type
2-Pole On-Off ^{1), 2)}	415V, 50Hz/8.5A	■ 3ST1 400-0AF08
3-Pole On-Off ^{1), 2)}		■ 3ST1 400-1AH08
Ammeter selector	0-L1-L2-L3	■ 3ST1 400-2RQ08
Voltmeter selector	0-L1L2-L2L3-L3L1	■ 3ST1 400-1RK08

1) 12th place code '8' represents black knob. Replace it by '9' for red knob.

2) 9th place code 'A' represents rotation < 360°. For 360° rotation, replace it by 'B'

Switch disconnecter: 3KA8^ (in open execution TPN)

Rated current Ie @690V 50Hz	SDF suitable for DIN type HRC fuses
63A	3KA81513TE00
100A	3KA82113TE00
125A	3KA82213TE00
160A	3KA82313TE00
200A	3KA83113UE00
250A	3KA83213UE00
400A	3KA83413UE00
630A	3KA83513UE00
800A	3KA843□-3UE00
1000A@	3KA844□-3UE00
1250A@	3KA845□-3UE00
1600A@	3KA846□-3UE00

□ - 2: Top Incoming

□ - 3: Bottom Incoming

^ 3KL8/ 3KA8 is rated for 690V, 50Hz, AC23A Utilisation Category

@ Rating AC21 at 500V, 50Hz

7KM PAC 3100 power monitoring device

Description	Type
PAC 3100 with integrated RS 485 port for MODBUS RTU Class 1 accuracy, screw terminals AC/DC wide voltage power supply 110...240V AC ±10%, 50/60Hz, 110...250V DC ±10%	7KM3133-0BA00-3AA0

Motor control switches 3LA0

Description		Motor output 415V, 50Hz, 3Ph kW	Type
In sheet steel housing	On/Off	7.5	■ 3LA0221-1YA
		30	■ 3LA0621-1YB
	System selector	5.5	3LA0222-1YA
	Reversing	5.5	■ 3LA0223-1YA

Moulded Case Circuit Breaker: 3VT1

Description	Type
3VT1 MCCBs	3VT17....
3VT91 Accessories	3VT91....

Discontinued products

MCCB: SENTRON 3VL

- Upto 16A to 1600A
- 3 pole & 4 pole versions
- Thermal magnetic and Microprocessor based trip unit



3VL MCCB, Thermal-magnetic trip unit (fixed overload and fixed short circuit), Icu = 55kA, 415V AC, 50 Hz

Frame size	Rated current I _n (A)	3 pole	4 pole
		Type	Type
VL160X VL160X = 3VL1	16	3VL1796-1DA36-0AA0	3VL1796-1EH46-0AA0
	20	3VL1702-1DA36-0AA0	3VL1702-1EH46-0AA0
	32	3VL1703-1DA36-0AA0	3VL1703-1EH46-0AA0
	63	3VL1706-1DA36-0AA0	3VL1706-1EH46-0AA0
	100	3VL1710-1DA36-0AA0	3VL1710-1EH46-0AA0
	125	3VL1712-1DA36-0AA0	3VL1712-1EH46-0AA0
	160	3VL1716-1DA36-0AA0	3VL1716-1EH46-0AA0

3VL MCCB, Thermal-magnetic trip unit (adjustable overload and short circuit), Icu = 55kA, 415V AC, 50 Hz

Frame size	Rated current I _n (A)	3 pole	4 pole
		Type	Type
VL160X / VL160 VL160X = 3VL1 VL160 = 3VL2	20	3VL1702-1DD36-0AA0	3VL1702-1EA46-0AA0#
	32	3VL1703-1DD36-0AA0	3VL1703-1EA46-0AA0#
	63	3VL1706-1DD36-0AA0	3VL2706-1EM46-0AA0
	100	3VL1710-1DD36-0AA0	3VL2710-1EM46-0AA0
	125	3VL1712-1DD36-0AA0	3VL2712-1EM46-0AA0
	160	3VL1716-1DD36-0AA0	3VL2716-1EM46-0AA0
VL 250	200	3VL3720-1DC36-0AA0	3VL3720-1EM46-0AA0
	250	3VL3725-1DC36-0AA0	3VL3725-1EM46-0AA0
VL 400	315	3VL4731-1DC36-0AA0	3VL4731-1EM46-0AA0
	400	3VL4740-1DC36-0AA0	3VL4740-1EM46-0AA0
VL 630	500	3VL5750-1DC36-0AA0	3VL5750-1EM46-0AA0
	630	3VL5763-1DC36-0AA0	3VL5763-1EM46-0AA0

3VL MCCB, Thermal-magnetic trip unit (adjustable overload and short circuit), Icu = 70kA, 415V AC, 50 Hz

Frame size	Rated current I _n (A)	3 pole	4 pole
		Type	Type
VL160X / VL160 VL160X = 3VL1 VL160 = 3VL2	20	3VL1702-2DD36-0AA0	3VL1702-2EA46-0AA0#
	32	3VL1703-2DD36-0AA0	3VL1703-2EA46-0AA0#
	63	3VL1706-2DD36-0AA0	3VL2706-2EM46-0AA0
	100	3VL1710-2DD36-0AA0	3VL2710-2EM46-0AA0
	125	3VL1712-2DD36-0AA0	3VL2712-2EM46-0AA0
	160	3VL1716-2DD36-0AA0	3VL2716-2EM46-0AA0
VL 250	200	3VL3720-2DC36-0AA0	3VL3720-2EM46-0AA0
	250	3VL3725-2DC36-0AA0	3VL3725-2EM46-0AA0
VL 400	315	3VL4731-2DC36-0AA0	3VL4731-2EM46-0AA0
	400	3VL4740-2DC36-0AA0	3VL4740-2EM46-0AA0
VL 630	500	3VL5750-2DC36-0AA0	3VL5750-2EM46-0AA0
	630	3VL5763-2DC36-0AA0	3VL5763-2EM46-0AA0

3VL MCCB for Motor protection (Magnetic trip unit, 3 Pole)

Frame size	Rated current I _n (A)	standard breaking capacity (55 kA, 415V, 50 Hz)	high breaking capacity (70 kA, 415V, 50 Hz)
		Type	Type
VL160	63 A	3VL2706-1DK36-0AA0	3VL2706-2DK36-0AA0
	100 A	3VL2710-1DK36-0AA0	3VL2710-2DK36-0AA0
	160 A	3VL2716-1DK36-0AA0	3VL2716-2DK36-0AA0
VL250	250 A	3VL3725-1DK36-0AA0	3VL3725-2DK36-0AA0
VL400	315 A	3VL4731-1DK36-0AA0	3VL4731-2DK36-0AA0
VL630	500 A	3VL5750-1DK36-0AA0	3VL5750-2DK36-0AA0

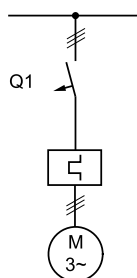

Fixed overload & fixed short circuit with neutral protection
Std. Pkg. = 1 unit

* LP - List Price

Discontinued products

3VL MCCB, ETU10, LI, Microprocessor based trip unit, Icu = 55kA, 415V AC, 50Hz

Frame size	Rated current (A)	3 pole	4 pole
		Type	Type
VL 160	63	3VL2706-1SB36-0AA0	3VL2706-1TA46-0AA0
	100	3VL2710-1SB36-0AA0	3VL2710-1TA46-0AA0
	160	3VL2716-1SB36-0AA0	3VL2716-1TA46-0AA0
VL 250	200	3VL3720-1SB36-0AA0	3VL3720-1TA46-0AA0
	250	3VL3725-1SB36-0AA0	3VL3725-1TA46-0AA0
VL 400	315	3VL4731-1SB36-0AA0	3VL4731-1TA46-0AA0
	400	3VL4740-1SB36-0AA0	3VL4740-1TA46-0AA0
VL 630	630	3VL5763-1SB36-0AA0	3VL5763-1TA46-0AA0
VL 800	800	3VL6780-1SB36-0AA0	3VL6780-1TA46-0AA0
VL 1250	1000	3VL7710-1SB36-0AA0	3VL7710-1TA46-0AA0
	1250	3VL7712-1SB36-0AA0	3VL7712-1TA46-0AA0
VL 1600	1600	3VL8716-1SB30-0AA0	3VL8716-1TA40-0AA0

3VL MCCB, ETU10, LI, Microprocessor based trip unit, Icu = 70kA, 415V AC, 50 Hz

Frame size	Rated current (A)	3 pole	4 pole
		Type	Type
VL 160	63	3VL2706-2SB36-0AA0	3VL2706-2TA46-0AA0
	100	3VL2710-2SB36-0AA0	3VL2710-2TA46-0AA0
	160	3VL2716-2SB36-0AA0	3VL2716-2TA46-0AA0
VL 250	200	3VL3720-2SB36-0AA0	3VL3720-2TA46-0AA0
	250	3VL3725-2SB36-0AA0	3VL3725-2TA46-0AA0
VL 400	315	3VL4731-2SB36-0AA0	3VL4731-2TA46-0AA0
	400	3VL4740-2SB36-0AA0	3VL4740-2TA46-0AA0
VL 630	630	3VL5763-2SB36-0AA0	3VL5763-2TA46-0AA0
VL 800	800	3VL6780-2SB36-0AA0	3VL6780-2TA46-0AA0
VL 1250	1000	3VL7710-2SB36-0AA0	3VL7710-2TA46-0AA0
	1250	3VL7712-2SB36-0AA0	3VL7712-2TA46-0AA0
VL 1600	1600	3VL8716-2SB30-0AA0	3VL8716-2TA40-0AA0

3VL MCCB, ETU12, LIG, Microprocessor based trip unit, Icu = 55kA, 415V AC, 50Hz

Frame size	Rated current (A)	3 pole	4 pole
		Type	Type
VL 160	63	3VL2706-1SL36-0AA0	3VL2706-1TN46-0AA0
	100	3VL2710-1SL36-0AA0	3VL2710-1TN46-0AA0
	160	3VL2716-1SL36-0AA0	3VL2716-1TN46-0AA0
VL 250	200	3VL3720-1SL36-0AA0	3VL3720-1TN46-0AA0
	250	3VL3725-1SL36-0AA0	3VL3725-1TN46-0AA0
VL 400	315	3VL4731-1SL36-0AA0	3VL4731-1TN46-0AA0
	400	3VL4740-1SL36-0AA0	3VL4740-1TN46-0AA0
VL 630	630	3VL5763-1SL36-0AA0	3VL5763-1TN46-0AA0
VL 800	800	3VL6780-1SL36-0AA0	3VL6780-1TN46-0AA0
VL 1250	1000	3VL7710-1SL36-0AA0	3VL7710-1TN46-0AA0
	1250	3VL7712-1SL36-0AA0	3VL7712-1TN46-0AA0
VL 1600	1600	3VL8716-1SL30-0AA0	3VL8716-1TN40-0AA0

3VL MCCB, ETU12, LIG Microprocessor based trip unit, Icu = 70kA, 415V AC, 50Hz

Frame size	Rated current (A)	3 pole	4 pole
		Type	Type
VL 160	63	3VL2706-2SL36-0AA0	3VL2706-2TN46-0AA0
	100	3VL2710-2SL36-0AA0	3VL2710-2TN46-0AA0
	160	3VL2716-2SL36-0AA0	3VL2716-2TN46-0AA0
VL 250	200	3VL3720-2SL36-0AA0	3VL3720-2TN46-0AA0
	250	3VL3725-2SL36-0AA0	3VL3725-2TN46-0AA0
VL 400	315	3VL4731-2SL36-0AA0	3VL4731-2TN46-0AA0
	400	3VL4740-2SL36-0AA0	3VL4740-2TN46-0AA0
VL 630	630	3VL5763-2SL36-0AA0	3VL5763-2TN46-0AA0
VL 800	800	3VL6780-2SL36-0AA0	3VL6780-2TN46-0AA0
VL 1250	1000	3VL7710-2SL36-0AA0	3VL7710-2TN46-0AA0
	1250	3VL7712-2SL36-0AA0	3VL7712-2TN46-0AA0
VL 1600	1600	3VL8716-2SL30-0AA0	3VL8716-2TN40-0AA0

L: Overload protection

I: Short circuit protection

G: Ground fault protection

Std. Pkg. = 1 unit

* LP - List Price

Discontinued products

3VL MCCB, Magnetic trip unit (for short circuit protection), Icu = 55kA, 415V AC, 50Hz

Frame size	Rated current I _n (A)	3 pole	4 pole
		Type	Type
VL400	400	3VL4740-1DE36-0AA0	3VL4740-1EE46-0AA0
VL630	630	3VL5763-1DE36-0AA0	3VL5763-1EE46-0AA0
VL800	800	3VL6780-1DE36-0AA0	3VL6780-1EE46-0AA0
VL1250	1250	3VL7712-1DE36-0AA0	3VL7712-1EE46-0AA0
VL1600	1600	3VL8716-1DE30-0AA0	3VL8716-1EE40-0AA0

3VL MCCB, Magnetic trip unit (for short circuit protection), Icu = 70kA, 415V AC, 50Hz

Frame size	Rated current I _n (A)	3 pole	4 pole
		Type	Type
VL400	400	3VL4740-2DE36-0AA0	3VL4740-2EE46-0AA0
VL630	630	3VL5763-2DE36-0AA0	3VL5763-2EE46-0AA0
VL800	800	3VL6780-2DE36-0AA0	3VL6780-2EE46-0AA0
VL1250	1250	3VL7712-2DE36-0AA0	3VL7712-2EE46-0AA0
VL1600	1600	3VL8716-2DE30-0AA0	3VL8716-2EE40-0AA0

Accessories for 3VL

Frame	VL 160 X / VL 160 / VL 250 / VL 400	VL 630 / VL 800 / VL 1250 / VL 1600
Accessory	Type	Type
Auxiliary switch	3VL9400-2AB00 (1NO + 1NC)	3VL9800-2AC00 (2NO + 2NC)
Auxiliary switch + Alarm switch	3VL9400-2AD00 (1NO + 1NC & 1NO)	3VL9800-2AE00 (1NO + 1NC & 1NO)
Under voltage release 110 V AC 220 - 250 V AC 415 V AC 110 V DC	3VL9400-1UG00 3VL9400-1UH00 3VL9400-1UJ00 3VL9400-1UR00	3VL9800-1UG00 3VL9800-1UH00 3VL9800-1UJ00 3VL9800-1UR00
Shunt release 24 V DC 110 - 127 V DC 110 - 127 V AC 208 - 277 V AC	3VL9400-1SC00 3VL9400-1SK00 3VL9400-1SR00 3VL9400-1ST00	3VL9800-1SC00 3VL9800-1SK00 3VL9800-1SR00 3VL9800-1ST00
Rotary drive kit (including 8UC handle with door interlock defeat & padlocking facility)	3VL9.00-3HQ00 ↓ 1 (For VL 160X) 3 (For VL 160/250) 4 (For VL 400)	3VL9600-3HQ00 (VL630-VL800) 3VL9800-3HF05 (VL1250-VL1600)
Motorised drive (Motorised operator-MO) 230-250V AC/DC	3VL9.00-3ME10 ↓ 1 (For VL160X) 3 (For VL160/250) 4 (For VL 400)	3VL9600-3ME10 (for VL630/800)
Motorised drive (Stored Energy Operator -SEO) 220-250V AC/DC	3VL9.00-3MQ00 ↓ 3 (For VL160X/VL160/VL250) 4 (For VL 400)	3VL9.00-3MQ00 ↓ 6 (For VL630-VL800) 8 (For VL1250-VL1600)
Spreader links (with phase barriers)	3VL9216-4ED30 (VL160X/VL160-3P) 3VL9216-4ED40 (VL160X/VL160-4P) 3VL9300-4ED30 (VL250-3P) 3VL9300-4ED40 (VL250-4P) 3VL9400-4ED30 (VL400-3P) 3VL9400-4ED40 (VL400-4P)	3VL9500-4ED30 (VL630-3P) 3VL9500-4ED40 ⁵⁵ (VL630-4P) 3VL9600-4ED30 (VL800-3P) 3VL9600-4ED40 ⁵⁵ (VL800-4P) NA (for VL1250 / VL1600)

Note: # The 11th and 12th place of the type reference will indicate the alphabet type of lock & key. Combinations available are A, B, C, D, A-, -B, -C, AB, AC. 11th place will be A, B, C, D for castell lock type A, B, C, D respectively. 11th and 12 place will be A0, 0B, 0C, AB, AC for castell lock type A-, -B, -C, AB, AC respectively

Spreader link 1 set = 3 nos. links and 2 nos. phase barriers in case of 3 pole and 5 nos. links and 3 nos. phase barriers in case of 4 pole, ⁵⁵ - 4 nos. links and 3 nos. phase barriers in case of 4 pole.

NA - Not Available

Std. Pkg. = 1 unit

* LP - List Price

One point contact for your service needs

The comprehensive range of services from Siemens is sure to cover the needs of the most varied users.

We offer structured services, designed to give you valuable support in every phase during the lifecycle of your low voltage products and panels – from warranty support to suitable retrofit solutions.

Additionally we also provide Energy Management solutions and Technology upgrade solutions for your existing switchgear.

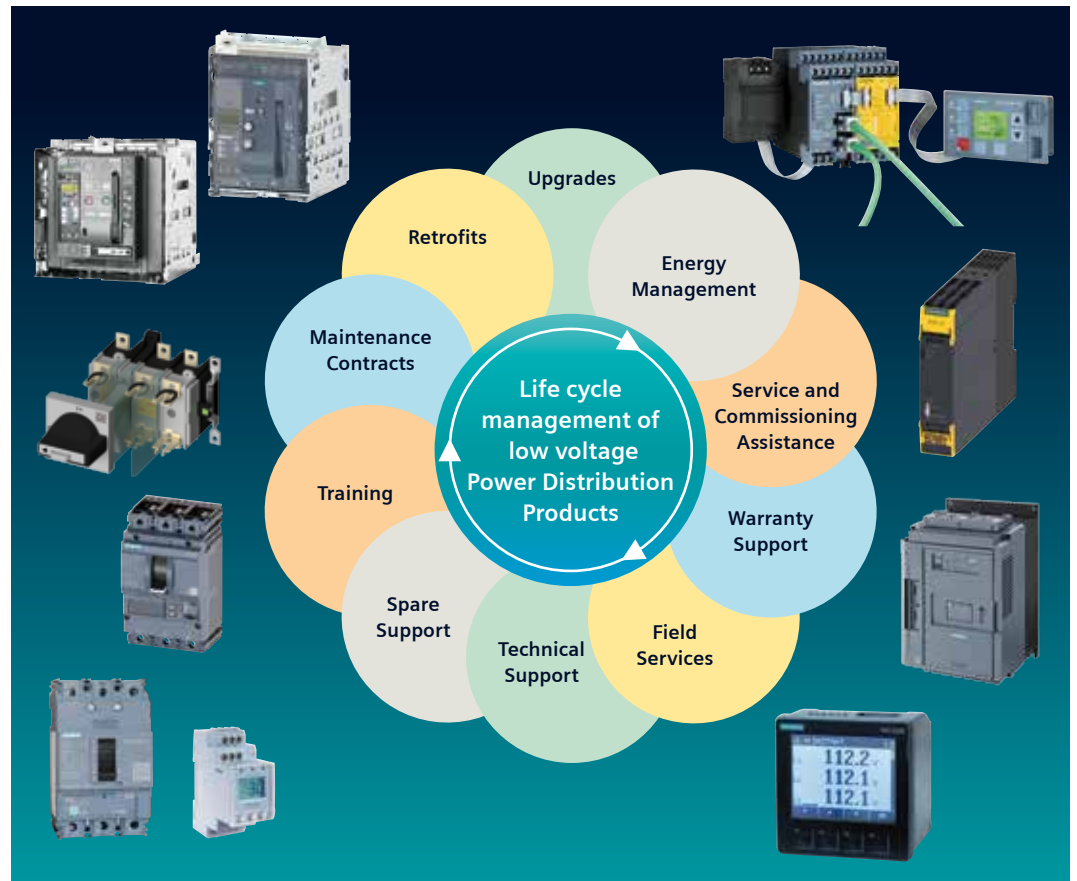

Service & spares for SIEPAN 8PU & SIRENEW (Solar ACDB) switchboards

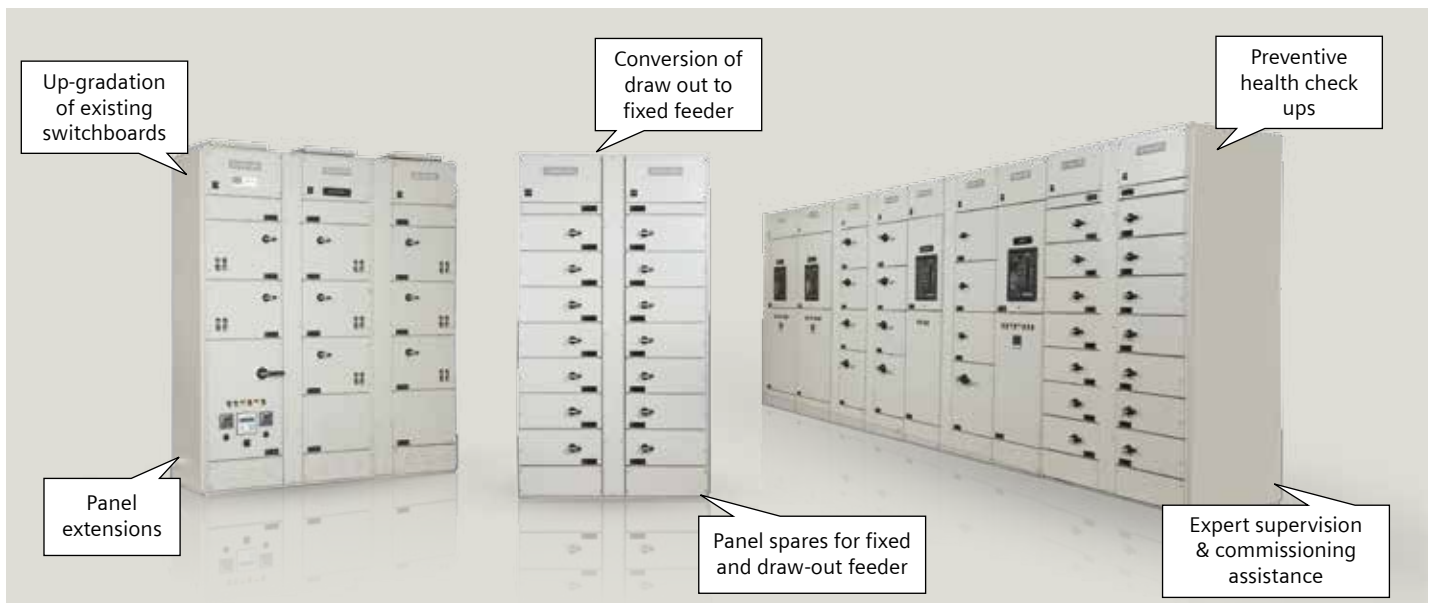

- Annual Maintenance contract of LV Switchboards
- Conversion of existing conventional to intelligent MCC
- Ready to use completely prewired draw out modules for MCC

Please get in touch with us for details

CUSTOMER CARE

Toll Free No: 1800220987/18002090987 • E-mail: ics.india@siemens.com



5SD Surge Protection Devices

Safe & Reliable

Surge Protection Devices are available in the following types:

Type 1 - For incoming power supply panels, in buildings with lightning protection system. Must be accompanied by downstream SPD

Type 2 - For distribution panels located downstream of Type 1 protectors or in incoming supply panels in areas of low exposure to lightning strikes, where the building is not fitted with lightning protection system

Type 3 - Always installed downstream of Type 2 protection designed to protect sensitive equipment or equipment located more than 20m downstream of Type 2 SPD

www.siemens.co.in

SIEMENS

For information on prices of below products please refer to the
LV Switchgear Motor Control Products valid Price list



Terms and conditions

Maximum Retail Price (MRP) / List Price (LP) is subject to revision without prior notice.

The company reserves the right to supply goods at its works or godown at its discretion.

The minimum order size for non-stock items (items not marked with ■) is 50 Nos. for each item or ₹ 50,000/- per item.

Export control regulation - retention clause: The fulfillment of the agreement on Siemens part is subject to the provision that this shall not be prevented by implements on the grounds of national and international legal requirements, in particular export control provision.

Stock items

The normal stock items (indicated by ■) are subject to change without prior notice.

Note

- This supercedes all previous Price Lists.
- List Prices (LPs) mentioned are exclusive of all taxes.
- Maximum Retail Prices (MRPs) mentioned in the publication are maximum recommended selling prices.
- Invoice amount not to exceed MRP
- Invoice amount = MRP (less) applicable discount + applicable GST %
- For receiving material in factory sealed packing, we request you to order in multiples of the indicated standard packing quantity.

Ask your nearest Siemens partners to include you in our mailing list.

Always make your purchases only from our authorised dealers. Details available with our sales office/territory managers.

Your partners

Sales offices:

Ahmedabad
3rd Floor, Prerna Arbour, Chimanlal Girdharlal Road
Navarangpura, Near Girish Coldrinks
Ahmedabad, Gujarat - 380009
☎ : +91 79 30927600
Fax: +91 79 30927699

Baroda
Ground Floor, Urja Bhavan, Maneja Works
Opp. Makarpura Railway Station
Vadodara - 390010
☎ : +91 265 3957701
Fax: +91 265 3039190

Bengaluru
1st Floor, Jyoti Mahal, No. 49, St. Marks Rd.
Bengaluru - 560 001
☎ : +91 80 33422000
Fax: +91 80 33424131

Bhubaneswar
Mobile: +91 7894436373
E-mail: somnath.manna@siemens.com

Territory managers:

Agra
Flat No 303, Dwarka Apartment
Near Hanuman Mandir Crossing
Bhagirathi Road, Khandari
Agra - 282003
Mobile: +91 7800960310
E-mail: tiwari.mayank@siemens.com

Aurangabad
Mobile: +91 9033563923
E-mail: shailendra-kumar.maurya@siemens.com

Belgaum
Anugrah Bungalow No. 2, Plot No. 7
CTS No. 2109, RS No. 57/2/1, Cross No. 7
Near Shanbag I Bhandari School, Bhagya Nagar, Angol
Belgavi, Karnataka - 590006
Mobile: +91 9740277991
Tel: +91 0831 2495156
E-mail: anand.gawade@siemens.com

Belgaum
3rd Floor, Anand Nivas, B wing, 6th Cross
Bhagyanagar, Near Police Booth, Belgavi
Karnataka - 590006
Mobile: +91 8105592066
E-mail: siddu.mareguddi@siemens.com

Bharuch
Mobile: +91 8884000998
E-mail: viral.kachhadia@siemens.com

Bhilai
Flat No. 408, 5th Floor, Harihar Nagar
Besa, Nagpur - 440037
Mobile: +91 7869922211
E-mail: pravin.deshbhara@siemens.com

Bhopal
A-88 Shahpura, Bhopal, MP - 462016
Mobile: +91 9823011883
E-mail: vineet.saxena@siemens.com

Boisar
Flat 110, Building M4, Tata Shubh Grih, Maan
Opp. D Mart, Boisar - 401506
Mobile: +91 9819231892
E-mail: debashis.biswas@siemens.com

Durgapur
Quarter No. C7, Kunustoria Area Complex
Near Pragati Stadium
Raniganj - 713362, West Bengal
Mobile: +91 9830317456
E-mail: harsh.chincholkar@siemens.com

Gandhidham
Plot No. 453, DC-5, Adipur
Gandhidham - 370205
Mobile: +91 9725005162
E-mail: maullikkumar.patel@siemens.com

Gorakhpur
H.No. 721/T, Sri Ram Nagar Colony
Near Aluminium Factory, Beside HK Memorial School
Basaratpur, Gorakhpur - 273004
Mobile: +91 8802011478
E-mail: singh.amar@siemens.com

Guwahati Assam
Shivalaya Housing Society, Flat No. B-3A
Bylane-4, Joymatinagar, Adabari, Pandu
Guwahati - 781012, Assam
Mobile: +91 9864110684
E-mail: biplob.datta@siemens.com

Haridwar
Mobile: +91 9889384222
E-mail: umesh.pandey@siemens.com

Chandigarh
Mobile: +91 9888484066
E-mail: padam.sharma@siemens.com

Chennai
4th Floor, ETA Mount Central
Seethakathi Business Centre, Mount Road
Chennai - 600006
☎ : +91 44 30474000
Fax: +91 44 30474080

Coimbatore
Mobile: +91 9849001842
E-mail: pramod.krishna@siemens.com

Gurugram
Plot No. 78, Tower - B, Jagatjit Industries Building (JIL)
Opposite SBI Academy, Sector-18
Gurugram - 122015
☎ : +91 124 2842000, 3810200

Hosur
Mobile: +91 9000451122
E-mail: chandrashekar.r@siemens.com

Hubli
Flat No. 303, Shriya Solitaire
Opp. Murudeshwar Ceramic Factory
RN Shetty Road, Hubli, Karnataka - 580024
Mobile: +91 9945961052
E-mail: kiran.kage@siemens.com

Indore
Flat No. 103, Block B, Moti Mahal Apartments
Gumasta Nagar, Scheme No. 71, Indore - 452009 (M. P.)
Mobile: +91 9029207888
E-mail: gaurishankar.ra@siemens.com

Indore
78, Anand Nagar, Chitwad Road, Indore - 452001 (MP)
Mobile: +91 9673333024
E-mail: brajesh.rathor@siemens.com

Jalandhar
H.No. 212A, Punjabi Bahq Extension, 66 Feet Road
Near Curo Mall, Jalandhar, Punjab - 141022
Mobile: +91 9876047929
E-mail: sunil.singla@siemens.com

Jammu
Plot No. 592/3, 2nd Floor, Bhawani Vihar Extension
Trikruta Nagar, Jammu - 180020
Mobile: +91 9873084776
E-mail: sharma.nikhil@siemens.com

Jodhpur
258-A Shastri Nagar, Jodhpur - 342003
Mobile: +91 8003088889
E-mail: ankur.pancholl@siemens.com

Kanpur
110-B, Gandhi Gram, Harjinder Nagar
Kanpur - 208007, Uttar Pradesh
Mobile: +91 9650235222
E-mail: manish.sahu@siemens.com

Kharagpur
Plot No. 3031, 2nd Floor, Mouza: Basudevpur
PO: Khajanchak, Manjushree More
District: Purba Medinipur, Pin: 721602
Mobile: +91 9051384193
E-mail: mitra.sayantan@siemens.com

Khopoli
Flat No. 2, B Wing, Ground Floor
Bonzer Celebration CHSL, Survey No. 6, Takai
Tal. Khalapur, Dist Raigad - 410203
Mobile: +91 9867021215
E-mail: akif.qadeer@siemens.com

Kolhapur
RS No. 84-1, Pinac Prasad, FL No. A-35
New Palace Road, Kolhapur - 416006
Mobile: +91 9850836839
E-mail: vinay.todkar@siemens.com

Kota
A-1, 1st Floor, Shreenath Estate
Station Road, Kota, Rajasthan - 324002
Mobile: +91 9929110493
E-mail: rajendra.kabra@siemens.com

Ludhiana
House No. 548, FF Urban Estate, Phase 1, Jamalpur
Chandigarh Road, Ludhiana - 141003 Punjab
Mobile: +91 9872131762
E-mail: gurvinder.singh@siemens.com

Ludhiana
H.No. 1235, St. No. 3/1, Sardar Nagar, Rahon Road
Near Gurudwara Mata Bhagwanti
Ludhiana - 141007, Punjab
Mobile: +91 9872419990
E-mail: ravinder.pal@siemens.com

Hyderabad
5-9-19, Lakshmi Narasinh Estate
Hyderabad - 500004
☎ : +91 40 23482578

Jaipur
Mobile: +91 9815502480
E-mail: rohit.jagga@siemens.com

Jamshedpur
Mobile: +91 8294052647
E-mail: shyamal.bhattacharyya@siemens.com

Kolkata
3rd Floor, 43, Shanti Palli, Rashbihari Bypass Connector
Kolkata - 700042, India
☎ : +91 33 30939000
Fax: +91 33 30939010

Lucknow
Mobile: +91 9918002525
E-mail: atul.shukla@siemens.com

Madurai
Dhanya Block, DF-02, Vasuthara Enclave
84, TPK Main Road, Andal Puram
Madurai - 625003, Tamil Nadu
Mobile: +91 9626699692
E-mail: balaji.sakthivel@siemens.com

Mangalore
Flat No. 303, Devi Dayal Residency
Near Dominic Church, Ashok Nagar Road
Urwa Store, Mangalore - 575006
Mobile: +91 9686488166
E-mail: lakshimisha.k@siemens.com

Meerut
110, Lotus Towers, Opp. Ansal Courtyard, Modipuram
Meerut - 250001, Uttar Pradesh
Mobile: +91 9889384222
E-mail: umesh.pandey@siemens.com

Mehsana
Mobile: +91 9909904993
E-mail: piyush.thaker@siemens.com

Mysore
No. 980, 4th Cross, 6th Main, Bannimantap B layout
SS Nagar, Mysore - 570015
Mobile: +91 9611311645
E-mail: raashid.syed@siemens.com

Naidupeta
5/94, I Floor, B Block, M.A.Nagar, Chennai - 600052
(Near Padianalur Govt School)
Mobile: +91 9840255185
E-mail: r.pradeep@siemens.com

Nashik
Flat No. 402, "D" Wing, Hari Shrushti
Near Jogging Track, Opposite WNS
Indira Nagar, Nashik - 422009
Mobile: +91 9892292275
E-mail: dhananjay.thorat@siemens.com

Neemrana
F 131, Japanese Zone, Anant Raj Apartments
Neemrana, Alwar, Rajasthan - 301705, India
Mobile: +91 9855526122
E-mail: kumar.manish@siemens.com

Patna
A-53, 5th Floor, Krishna Apartment
Boring Road, Patna - 800001
Mobile: +91 9641574289
E-mail: rajendra.mitra@siemens.com

Pondicherry
Door No. 102, Second Floor, Chellan Nagar Main Road
Near Rainbow Nagar Park, Pondicherry - 605011
Mobile: +91 8939883966
E-mail: kolappan.c@siemens.com

Raipur
103-Emerald, Green Meadows, Dalal Seoni
Mowa, Raipur, Chattisgarh - 492007
Mobile: +91 9711007466
E-mail: vinay.mittal@siemens.com

Rajahmundry
IVY Grand Apartment, Narasanna Nagar
Door No. 66-7-2/1A, Rajiv Gandhi Street
Near Karanam Gar Junction, Kakkinada - 533004
Mobile: +91 9789869754
E-mail: lakshmitkanth.ballal@siemens.com

Rajkot
Pitrukrupa Street No. 5, Royal Park Society
University Road, Near Indra Cercle, Rajkot - 360005
Mobile: +91 8080802037
E-mail: harsh.trivedi@siemens.com

Mumbai
Business Centre-1, Kalwa Works
Thane Belapur Road
Thane - 400 601
☎ : +91 22 39663000
Fax: +91 22 39663721

Nagpur
Mobile: +91 9930182128
E-mail: muzaffer.sayed@siemens.com

Pune
Tower C, Panchshil Business Park
Survey No. 20, Balewadi
Pune - 411045
☎ : +91 20 30466000
Fax: +91 20 30466060

Vizag
Mobile: +91 9701354777
E-mail: vijaykiran.meduri@siemens.com

Ranchi
Raj Enclave, Flat No. 204, 2nd Floor
Kaju Bagan (Near DAV Hehal Jr. Section)
Piska More, P.S. Sukhdeoanagar, Ranchi - 834005
Mobile: +91 9674011440
E-mail: sarkar.saikat@siemens.com

Renukoot
Vijay Gupta Bhawan
Swami Vivekanand Colony, Murdhawa
Renukoot - 231217, Distt Sonebhadra, Uttar Pradesh
Mobile: +91 9984500021
E-mail: kumardeepak@siemens.com

Rourkela
Civil Town Ship, 3rd Lane, Rourkela - 769004
Mobile: +91 9861056581
E-mail: ashirbad.das@siemens.com

Rudrapur
Shanti Vihar Colony, Chatarpur Road
Opposite Dr. Pandey Hospital, Rudrapur - 263153
Distt. Udham Singh Nagar, Uttrakhand
Mobile: +91 9839174578
E-mail: girish.pandey@siemens.com

Salem
Sri Krishna Nivasam Apartment, B2, 2nd Floor
Vidya Ashramam Salai, Shankar Nagar, Salem - 636007
Mobile: +91 9952898993
E-mail: b.saravanan@siemens.com

Siliguri
147 Lala Lajpat Rai Road, Haldai Para
Siliguri - 734001, West Bengal
Mobile: +91 7278842360
E-mail: abhishek.kar@siemens.com

Sonipat
Mobile: +91 +91 9650481919
E-mail: deepak.beniwal@siemens.com

Sriperumbudur
Mobile: +91 9071161117
E-mail: mohanjay@siemens.com

Surat
A1-504, Shradha Flats, Near Swastik Villa, Pal
Surat - 395009
Mobile: +91 9879110276
E-mail: rahul.gangrade@siemens.com

Thrissur
Kanmanayacal House, Kurichikara PO
Ponganamkadu, Thrissur
Mobile: +91 9947957839
E-mail: nobin.babu@siemens.com

Trichy
Flat No.102, 'B' Block, 2nd Floor
Vignesh Empire Apartments, Salai Road
Woraiyur, Trichy - 620003
Mobile: +91 8056025127
E-mail: ponnivalavan.p@siemens.com

Udaipur
A-39, First Floor, New Ahinsapuri, Fatehpura
Udaipur, Rajasthan - 313004, India
Mobile: +91 8696222212
E-mail: rohit.nandan@siemens.com

Vapi
Flat No. 302, 3rd Floor, Samrajya-IV, Royal Residency
Gokul Vihar Township, Charwada Road, Taluka - Pardi
Dist. Valsad, Vapi - 396195
Mobile: +91 9825147957
E-mail: rohit.darji@siemens.com

Vijaywada
Lakshmi Nilayam, H.No 77-135-11, 1st Floor, Dr. Colony
Sundarayya Nagar Colony, Payakapuram
Vijaywada - 520015, AP
Mobile: +91 9642351144
E-mail: venkateshwar.d@siemens.com

Siemens Limited
Smart Infrastructure
Electrical Products
R&D Technology Centre
Thane Belapur Road
Airoli Node, Navi Mumbai - 400708
For more information contact toll free 1800 209 1800
E-mail: lvsg-rmktg.india@siemens.com

www.siemens.co.in

Order No.: 111805397
SI-EP-PO-PL-1021
(This replaces SI-EP-PO-PL-1220
dated 1st December, 2020)

Customer Care Toll free no. 1800 209 0987
Email: ics.india@siemens.com

Product upgradation is a continuous process. Hence, data in this pricelist is subject to change without prior notice. For the latest information, please get in touch with our Sales Offices.