

Kindly contact at [info@sbsyscon.in](mailto:info@sbsyscon.in) ( S B Syscon Pvt Ltd ) for best prices -  
Authorised Channel Partner for Siemens



# Our commitment is **your safe future**

Electrical Installations from A to Z  
Price List w.e.f. 1st October, 2021



**SIEMENS**

Kindly contact at [info@sbsyscon.in](mailto:info@sbsyscon.in) ( S B Syscon Pvt Ltd ) for best prices -  
Authorised Channel Partner for Siemens



## Reliable protection by preventing electrical fires

With Arc Fault Detection Device

-  Reliably detecting and shutting down hazardous arcing faults. Lower probability of electrical fires
-  Unique compact 1 module width AFDD with integrated MCB or RCBO. Easy for modification in existing installation
-  Self-test function checks the functionality of device everyday and intelligent algorithms to prevent nuisance tripping due to switching arc



Sr. No.	Items	Pg. No.
<b>1</b>	<b>Betagard Miniature Circuit Breakers</b>	
	5SL6, 7.5kA with C characteristics	5
	5SL6, 7.5kA with B characteristics	6
	5SL4, 10kA with C characteristics	7
	5SL7, with C characteristics	8
	5SL7, with D characteristics	9
<b>2</b>	<b>Betagard Circuit Breakers</b>	
	5SL7, with K characteristics <span style="color: orange; font-weight: bold;">NEW</span>	11
	5SL4, with Z characteristics <span style="color: orange; font-weight: bold;">NEW</span>	12
	5SY4, 10kA CBs with C characteristics	13
	5SP4, 10kA with C and D characteristics	13
<b>3</b>	<b>Betagard Isolators</b>	
	5TL1 Isolators	14
<b>4</b>	<b>Betagard DC Circuit Breakers</b>	
	5SL5, 10kA DC with C characteristics	14
	5SL5, 4-pole DC with C Characteristics <span style="color: orange; font-weight: bold;">NEW</span>	15
<b>5</b>	<b>Betagard Residual Current Circuit Breakers</b>	
	5SV RCCB - Type AC, Type A	18
	5SM3 RCCB - Type AC, Type A	19
<b>6</b>	<b>Betagard Residual Current Breaker Operators</b>	
	5SU1 RCBO, 10kA, Type AC with C and D characteristics	20
	5SU1 RCBO, 10kA, Type A with C and D characteristics	21
<b>7</b>	<b>Betagard Accessories</b>	22
<b>8</b>	SIRENEW	23
<b>9</b>	Arc Fault Detection Devices (AFDD) <span style="color: orange; font-weight: bold;">NEW</span>	24-27
<b>10</b>	<b>Betagard Distribution Boards</b>	
	8GB32 SPN, TPN & Phase Segregated DBs	29-31
	Industrial Plug & Socket DBs, Simbox WP DBs	32
	Accessories for Betagard DBs	33
<b>11</b>	<b>Sentron Surge Protection Devices</b>	
	Surge Protection Devices	34-37
<b>12</b>	<b>Sentron Modular Devices</b>	
	Changeover switches, Insta contactors	39
	Twilight switch, Voltage relays, Indicators and Fuse monitors	40
	Time switches	41
<b>13</b>	SINOVA MCCBs - 3VJ, <span style="color: orange; font-weight: bold;">NEW</span>	42-44
	RAJA* Starters ordering info	
<b>14</b>	Switch Disconnecter Fuses - 3KL and Fuses - 3NA/3NW ordering info	45
<b>15</b>	Available till stocks last	46-48
<b>16</b>	Discontinued products	49
<b>17</b>	Sentron 7KN Powercenter 1000 <span style="color: orange; font-weight: bold;">NEW</span>	50-51
<b>18</b>	Multi channel current measuring system	52-53
<b>19</b>	Technical Information	54-55
<b>20</b>	Customer Care	56

# Betagard 5SL MCBs – Inspiring Safety

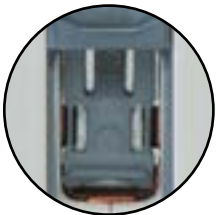

Terminal covers for protection

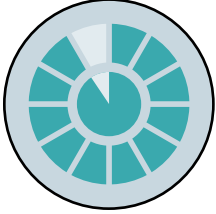

High Endurance Cycle



Ergonomic Handle for Identification



High Breaking capacity (Icn)

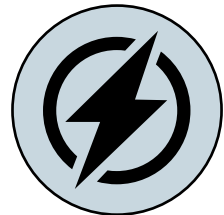

Very low watt loss



High ambient temperature

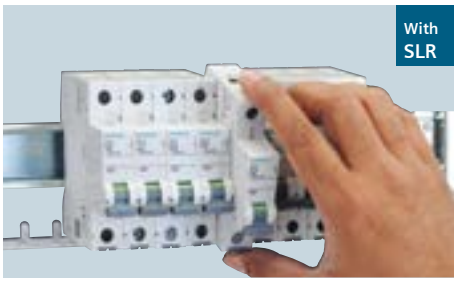
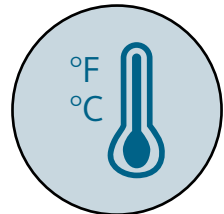

With SLR

Unique SLR (Slide Latch-Release) feature for tool free removal from DIN rail allows individual MCB to be removed from bus bar mounted assembly without disturbing other devices

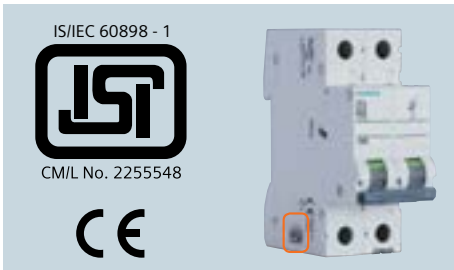

BIS approval for ISI marking as per latest IS/IEC 60898-1:2015 for assured quality and protection

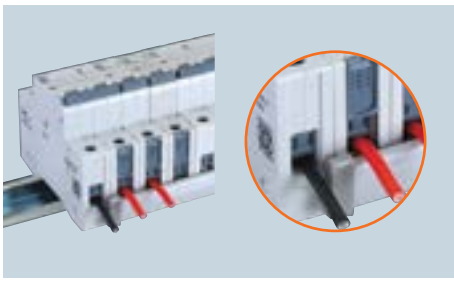





Unique termination mechanism enables firm mounting of Bus bar together with wire; and provides front access to wires for safe installation

## Betagard Miniature Circuit Breakers 5SL6, with C Characteristics



- Standards: IS/IEC 60898-1:2015
- Voltage: Un 240/415V, 50...60Hz^
- With ISI marking: CM/L No. 2255548

7500A	Rated Current $I_n$ (A)	MW#	Reference No	Unit MRP* ₹	Std. Pkg.** (Nos.)	
	1P, 240/415V AC	0.5	1			
		0.5	1	5SL61057RC	448.-	1/12
		1		■ 5SL61017RC	448.-	1/12
		2		5SL61027RC	448.-	1/12
		3		5SL61037RC	448.-	1/12
		4		■ 5SL61047RC	448.-	1/12
		6		■ 5SL61067RC	277.-	1/12
		8		5SL61087RC	277.-	1/12
		10		■ 5SL61107RC	277.-	1/12
		13		5SL61137RC	277.-	1/12
		16		■ 5SL61167RC	277.-	1/12
		20		■ 5SL61207RC	277.-	1/12
		25		5SL61257RC	277.-	1/12
		32		5SL61327RC	277.-	1/12
		40		5SL61407RC	611.-	1/12
	50		5SL61507RC	703.-	1/12	
	63		5SL61637RC	703.-	1/12	
	2P, 415V AC	0.5	2			
		0.5	2	5SL62057RC	1197.-	1/6
		1		5SL62017RC	1197.-	1/6
		2		5SL62027RC	1197.-	1/6
		3		5SL62037RC	1197.-	1/6
		4		5SL62047RC	1197.-	1/6
		6		■ 5SL62067RC	896.-	1/6
		8		5SL62087RC	896.-	1/6
		10		■ 5SL62107RC	896.-	1/6
		13		5SL62137RC	896.-	1/6
		16		5SL62167RC	896.-	1/6
		20		■ 5SL62207RC	896.-	1/6
		25		5SL62257RC	896.-	1/6
		32		5SL62327RC	896.-	1/6
		40		5SL62407RC	1258.-	1/6
	50		5SL62507RC	1476.-	1/6	
	63		5SL62637RC	1476.-	1/6	
	3P, 415V AC	0.5	3			
		0.5	3	5SL63057RC	1681.-	1/4
		1		5SL63017RC	1681.-	1/4
		2		5SL63027RC	1681.-	1/4
		4		5SL63047RC	1681.-	1/4
		6		■ 5SL63067RC	1346.-	1/4
		10		■ 5SL63107RC	1346.-	1/4
		16		■ 5SL63167RC	1346.-	1/4
		20		5SL63207RC	1346.-	1/4
		25		5SL63257RC	1346.-	1/4
		32		■ 5SL63327RC	1346.-	1/4
		40		■ 5SL63407RC	1884.-	1/4
		50		5SL63507RC	2104.-	1/4
		63		■ 5SL63637RC	2104.-	1/4
		4P, 415V AC	0.5	4		
		0.5	4	5SL64057RC	2321.-	1/3
		1		5SL64017RC	2321.-	1/3
		2		5SL64027RC	2321.-	1/3
		4		5SL64047RC	2321.-	1/3
		6		5SL64067RC	1861.-	1/3
		10		5SL64107RC	1861.-	1/3
		16		5SL64167RC	1861.-	1/3
		20		5SL64207RC	1861.-	1/3
		25		5SL64257RC	1861.-	1/3
		32		5SL64327RC	1861.-	1/3
		40		■ 5SL64407RC	2405.-	1/3
		50		5SL64507RC	2785.-	1/3
		63		■ 5SL64637RC	2785.-	1/3

■ Stock items

Note:

\* MRP - Maximum Retail Price

# 1MW (Module Width) = 18mm

\*\* Purchase MOQ for our authorised dealers is in multiples of standard packing, contact Siemens Sales Office for further details





^ Suitable for DC networks in Telecom application; 60V DC for 1P & 110V DC for 2P (contact sales office for connection diagram)

Miniature Circuit Breakers



## Betagard Miniature Circuit Breakers 5SL6, with B Characteristics

- **Standards:** IS/IEC 60898-1:2015
- **Voltage:** Un 240/415V, 50...60Hz
- **With ISI marking:** CM/L No. 2255548

7500A	Rated Current $I_n$ (A)	MW#	Reference No	Unit MRP* ₹	Std. Pkg.** (Nos.)
1P, 240/415V AC  	6	1	■ 5SL61066RC	273.-	1/12
	10		5SL61106RC	273.-	1/12
	16		5SL61166RC	273.-	1/12
	20		5SL61206RC	273.-	1/12
	25		5SL61256RC	273.-	1/12
	32		5SL61326RC	273.-	1/12
	40		5SL61406RC	608.-	1/12
	50		5SL61506RC	683.-	1/12
	63		5SL61636RC	683.-	1/12
	2P, 415V AC  		6	2	5SL62066RC
10		5SL62106RC	886.-		1/6
16		5SL62166RC	886.-		1/6
20		5SL62206RC	886.-		1/6
25		5SL62256RC	886.-		1/6
32		5SL62326RC	886.-		1/6
40		5SL62406RC	1246.-		1/6
50		5SL62506RC	1465.-		1/6
63		5SL62636RC	1465.-		1/6
3P, 415V AC  		6	3		5SL63066RC
	10	5SL63106RC		1346.-	1/4
	16	5SL63166RC		1346.-	1/4
	20	5SL63206RC		1346.-	1/4
	25	5SL63256RC		1346.-	1/4
	32	5SL63326RC		1346.-	1/4
	40	5SL63406RC		1859.-	1/4
	50	5SL63506RC		2086.-	1/4
	63	5SL63636RC		2086.-	1/4
	4P, 415V AC  	6		4	5SL64066RC
10		5SL64106RC	1851.-		1/3
16		5SL64166RC	1851.-		1/3
20		5SL64206RC	1851.-		1/3
25		5SL64256RC	1851.-		1/3
32		5SL64326RC	1851.-		1/3
40		5SL64406RC	2310.-		1/3
50		5SL64506RC	2776.-		1/3
63		5SL64636RC	2776.-		1/3

■ Stock items

Note:

\* MRP - Maximum Retail Price # 1MW (Module Width) = 18mm





\*\* Purchase MOQ for our authorised dealers is in multiples of standard packing, contact Siemens Sales Office for further details





**Betagard Miniature Circuit Breakers**  
**5SL4, with C characteristics**

- Standards: IS/IEC 60898-1:2015
- Voltage: Un 240/415V, 50...60Hz<sup>^</sup>
- Breaking capacity: 10kA as per IS/IEC 60898-1
- With ISI marking: CM/L No. 2255548

10000A	Rated Current I <sub>n</sub> (A)	MW#	Reference No	Unit MRP* ₹	Std. Pkg.** (Nos.)
	1P, 240/415V AC	1	5SL41057RC	500.-	1/12
	2	5SL41027RC	500.-	1/12	
	3	5SL41037RC	500.-	1/12	
	4	5SL41047RC	500.-	1/12	
	6	5SL41067RC	324.-	1/12	
	8	5SL41087RC	324.-	1/12	
	10	5SL41107RC	324.-	1/12	
	13	5SL41137RC	324.-	1/12	
	16	5SL41167RC	324.-	1/12	
	20	5SL41207RC	324.-	1/12	
	25	5SL41257RC	324.-	1/12	
	32	5SL41327RC	324.-	1/12	
	40	5SL41407RC	706.-	1/12	
	50	5SL41507RC	726.-	1/12	
63	5SL41637RC	726.-	1/12		
	2P, 415V AC	2	5SL42057RC	1341.-	1/6
	2	5SL42027RC	1341.-	1/6	
	3	5SL42037RC	1341.-	1/6	
	4	5SL42047RC	1341.-	1/6	
	6	5SL42067RC	961.-	1/6	
	8	5SL42087RC	961.-	1/6	
	10	5SL42107RC	961.-	1/6	
	13	5SL42137RC	961.-	1/6	
	16	5SL42167RC	961.-	1/6	
	20	5SL42207RC	961.-	1/6	
	25	5SL42257RC	961.-	1/6	
	32	5SL42327RC	961.-	1/6	
	40	5SL42407RC	1550.-	1/6	
	50	5SL42507RC	1550.-	1/6	
63	5SL42637RC	1550.-	1/6		
	3P, 415V AC	3	5SL43057RC	2166.-	1/4
	2	5SL43027RC	2166.-	1/4	
	3	5SL43037RC	2166.-	1/4	
	4	5SL43047RC	2166.-	1/4	
	6	5SL43067RC	1614.-	1/4	
	8	5SL43087RC	1614.-	1/4	
	10	5SL43107RC	1614.-	1/4	
	13	5SL43137RC	1614.-	1/4	
	16	5SL43167RC	1614.-	1/4	
	20	5SL43207RC	1614.-	1/4	
	25	5SL43257RC	1614.-	1/4	
	32	5SL43327RC	1614.-	1/4	
	40	5SL43407RC	2442.-	1/4	
	50	5SL43507RC	2442.-	1/4	
63	5SL43637RC	2442.-	1/4		
	4P, 415V AC	4	5SL44057RC	2724.-	1/3
	2	5SL44027RC	2724.-	1/3	
	3	5SL44037RC	2724.-	1/3	
	4	5SL44047RC	2724.-	1/3	
	6	5SL44067RC	2235.-	1/3	
	8	5SL44087RC	2235.-	1/3	
	10	5SL44107RC	2235.-	1/3	
	13	5SL44137RC	2235.-	1/3	
	16	5SL44167RC	2235.-	1/3	
	20	5SL44207RC	2235.-	1/3	
	25	5SL44257RC	2235.-	1/3	
	32	5SL44327RC	2235.-	1/3	
	40	5SL44407RC	3048.-	1/3	
	50	5SL44507RC	3048.-	1/3	
63	5SL44637RC	3048.-	1/3		

Miniature Circuit Breakers

■ Stock items

Note: \* MRP - Maximum Retail Price # 1MW (Module Width) = 18mm

\*\* Purchase MOQ for our authorised dealers is in multiples of standard packing, contact Siemens Sales Office for further details

^ Suitable for DC networks in Telecom application; 60V DC for 1P & 110V DC for 2P (contact sales office for connection diagram)

**Betagard Miniature Circuit Breakers**  
**5SL7, with C characteristics**

- Standards: IS/IEC 60898-1:2015
- Voltage: Un 240/415V, 50....60Hz
- Breaking capacity: 15kA<sup>1)</sup> as per IS/IEC 60898-1
- With ISI marking: CM/L No. 2255548

	Rated Current I <sub>n</sub> (A)	MW#	Reference No	Unit MRP* ₹	Std. Pkg.** (Nos.)
1P, 240/415V AC 	2	1	5SL71027RC	550.-	1/12
	4		5SL71047RC	550.-	1/12
	6		5SL71067RC	475.-	1/12
	10		5SL71107RC	475.-	1/12
	16		5SL71167RC	475.-	1/12
	20		5SL71207RC	475.-	1/12
	25		5SL71257RC	475.-	1/12
	32		5SL71327RC	475.-	1/12
	40		5SL71407RC	745.-	1/12
	50		5SL71507RC	755.-	1/12
	63		5SL71637RC	755.-	1/12
2P, 415V AC 	2	2	5SL72027RC	1480.-	1/6
	4		5SL72047RC	1480.-	1/6
	6		5SL72067RC	1080.-	1/6
	10		5SL72107RC	1080.-	1/6
	16		5SL72167RC	1080.-	1/6
	20		5SL72207RC	1080.-	1/6
	25		5SL72257RC	1080.-	1/6
	32		5SL72327RC	1080.-	1/6
	40		5SL72407RC	1625.-	1/6
	50		5SL72507RC	1625.-	1/6
	63		5SL72637RC	1625.-	1/6
3P, 415V AC 	2	3	5SL73027RC	2275.-	1/4
	4		5SL73047RC	2275.-	1/4
	6		5SL73067RC	1710.-	1/4
	10		5SL73107RC	1710.-	1/4
	16		5SL73167RC	1710.-	1/4
	20		5SL73207RC	1710.-	1/4
	25		5SL73257RC	1710.-	1/4
	32		5SL73327RC	1710.-	1/4
	40		5SL73407RC	2555.-	1/4
	50		5SL73507RC	2555.-	1/4
	63		5SL73637RC	2555.-	1/4
4P, 415V AC 	2	4	5SL74027RC	2865.-	1/3
	4		5SL74047RC	2865.-	1/3
	6		5SL74067RC	2295.-	1/3
	10		5SL74107RC	2295.-	1/3
	16		5SL74167RC	2295.-	1/3
	20		5SL74207RC	2295.-	1/3
	25		5SL74257RC	2295.-	1/3
	32		5SL74327RC	2295.-	1/3
	40		5SL74407RC	3215.-	1/3
	50		5SL74507RC	3215.-	1/3
	63		5SL74637RC	3215.-	1/3

Note:

\* MRP - Maximum Retail Price # 1MW (Module Width) = 18mm

\*\* Purchase MOQ for our authorised dealers is in multiples of standard packing, contact Siemens Sales Office for further details

<sup>1)</sup> Breaking capacity 63A - 10kA



**Betagard Miniature Circuit Breakers**  
**5SL7, with D characteristics**



- Standards: IS/IEC 60898-1
- Voltage: Un 240/415V, 50....60Hz
- Breaking capacity: 15kA<sup>1)</sup> as per IS/IEC 60898-1
- With ISI marking: CM/L No. 2255548

	Rated Current <i>I<sub>n</sub></i> (A)	MW#	Reference No	Unit MRP* ₹	Std. Pkg.** (Nos.)
1P, 240/415V AC 	2	1	5SL71028RC	550.-	1/12
	4		5SL71048RC	550.-	1/12
	6		5SL71068RC	495.-	1/12
	10		5SL71108RC	495.-	1/12
	16		5SL71168RC	495.-	1/12
	20		5SL71208RC	495.-	1/12
	25		5SL71258RC	495.-	1/12
	32		5SL71328RC	495.-	1/12
	40		5SL71408RC	960.-	1/12
	50		5SL71508RC	960.-	1/12
63		5SL71638RC	960.-	1/12	
2P, 415V AC 	2	2	5SL72028RC	1480.-	1/6
	4		5SL72048RC	1480.-	1/6
	6		5SL72068RC	1135.-	1/6
	10		5SL72108RC	1135.-	1/6
	16		5SL72168RC	1135.-	1/6
	20		5SL72208RC	1135.-	1/6
	25		5SL72258RC	1135.-	1/6
	32		5SL72328RC	1135.-	1/6
	40		5SL72408RC	2100.-	1/6
	50		5SL72508RC	2100.-	1/6
63		5SL72638RC	2100.-	1/6	
3P, 415V AC 	2	3	5SL73028RC	2275.-	1/4
	4		5SL73048RC	2275.-	1/4
	6		5SL73068RC	1800.-	1/4
	10		5SL73108RC	1800.-	1/4
	16		5SL73168RC	1800.-	1/4
	20		5SL73208RC	1800.-	1/4
	25		5SL73258RC	1800.-	1/4
	32		5SL73328RC	1800.-	1/4
	40		5SL73408RC	3275.-	1/4
	50		5SL73508RC	3275.-	1/4
63		5SL73638RC	3275.-	1/4	
4P, 415V AC 	2	4	5SL74028RC	2910.-	1/3
	4		5SL74048RC	2910.-	1/3
	6		5SL74068RC	2380.-	1/3
	10		5SL74108RC	2380.-	1/3
	16		5SL74168RC	2380.-	1/3
	20		5SL74208RC	2380.-	1/3
	25		5SL74258RC	2380.-	1/3
	32		5SL74328RC	2380.-	1/3
	40		5SL74408RC	4110.-	1/3
	50		5SL74508RC	4110.-	1/3
63		5SL74638RC	4110.-	1/3	

Note:

\* MRP - Maximum Retail Price # 1MW (Module Width) = 18mm

\*\* Purchase MOQ for our authorised dealers is in multiples of standard packing, contact Siemens Sales Office for further details

<sup>1)</sup> Breaking capacity 40A - 63A: 10kA



## 5SL Circuit Breaker - K & Z Curve

### **"K" Characteristic Trip Curve:**

MCB trips instantaneously when the current flowing through it reaches between 10 to 14 times the rated current.

Suitable for inductive and motor loads with high inrush currents; etc

### **"Z" Characteristic Trip Curve:**

MCB trips when the current flowing through it reaches between 2 to 3 times the rated current, highly sensitive to short circuit current

Suitable for the protection of highly sensitive devices such as semiconductor devices,

- In compliance with standards IEC 60947-2
- Range available from 2A – 63A
- Comprehensive features & accessories in line with 5SL MCB
- For protection in Industrial, Infrastructure, Process Automation, Commercial applications

**Betagard Circuit Breakers**  
**5SL7, with K characteristics**

**NEW**

- Standards: IS/IEC 60947-2
- Voltage: Un 240/415V, 50....60Hz
- Breaking capacity: 15kA<sup>1)</sup> as per IS/IEC 60947-2

	Rated Current <i>I<sub>n</sub></i> (A)	MW#	Reference No	Unit MRP* ₹	Std. Pkg.** (Nos.)
1P, 240/415V AC 	2	1	5SL71023RC	505.-	1/12
	4		5SL71043RC	505.-	1/12
	6		5SL71063RC	450.-	1/12
	10		5SL71103RC	450.-	1/12
	16		5SL71163RC	450.-	1/12
	20		5SL71203RC	450.-	1/12
	25		5SL71253RC	450.-	1/12
	32		5SL71323RC	450.-	1/12
	40		5SL71403RC	810.-	1/12
63	5SL71633RC	925.-	1/12		
2P, 415V AC 	2	2	5SL72023RC	1515.-	1/6
	4		5SL72043RC	1515.-	1/6
	6		5SL72063RC	1400.-	1/6
	10		5SL72103RC	1400.-	1/6
	16		5SL72163RC	1400.-	1/6
	20		5SL72203RC	1400.-	1/6
	25		5SL72253RC	1400.-	1/6
	32		5SL72323RC	1400.-	1/6
	40		5SL72403RC	1725.-	1/6
63	5SL72633RC	1950.-	1/6		
3P, 415V AC 	2	3	5SL73023RC	2350.-	1/4
	4		5SL73043RC	2350.-	1/4
	6		5SL73063RC	2150.-	1/4
	10		5SL73103RC	2150.-	1/4
	16		5SL73163RC	2150.-	1/4
	20		5SL73203RC	2150.-	1/4
	25		5SL73253RC	2150.-	1/4
	32		5SL73323RC	2150.-	1/4
	40		5SL73403RC	2440.-	1/4
63	5SL73633RC	2690.-	1/4		
4P, 415V AC 	2	4	5SL74023RC	3000.-	1/3
	4		5SL74043RC	3000.-	1/3
	6		5SL74063RC	2830.-	1/3
	10		5SL74103RC	2830.-	1/3
	16		5SL74163RC	2830.-	1/3
	20		5SL74203RC	2830.-	1/3
	25		5SL74253RC	2830.-	1/3
	32		5SL74323RC	2830.-	1/3
	40		5SL74403RC	3150.-	1/3
63	5SL74633RC	3480.-	1/3		

Note:

\* MRP - Maximum Retail Price # 1MW (Module Width) = 18mm

\*\* Purchase MOQ for our authorised dealers is in multiples of standard packing, contact Siemens Sales Office for further details

<sup>1)</sup> Breaking capacity 40A - 63A: 10kA

**Betagard Circuit Breakers**  
**5SL4, with Z characteristics**

**NEW**

- Standards: IS/IEC 60947-2
- Voltage: Un 240/415V, 50....60Hz
- Breaking capacity: 10kA as per IS/IEC 60947-2

	Rated Current $I_n$ (A)	MW#	Reference No	Unit MRP* ₹	Std. Pkg.** (Nos.)
1P, 240/415V AC 	2	1	5SL41020RC	700.-	1/12
	4		5SL41040RC	700.-	1/12
	6		5SL41060RC	550.-	1/12
	10		5SL41100RC	550.-	1/12
	16		5SL41160RC	550.-	1/12
	20		5SL41200RC	550.-	1/12
	25		5SL41250RC	550.-	1/12
	32		5SL41320RC	550.-	1/12
	40		5SL41400RC	725.-	1/12
	63		5SL41630RC	725.-	1/12
2P, 415V AC 	2	2	5SL42020RC	1325.-	1/6
	4		5SL42040RC	1325.-	1/6
	6		5SL42060RC	1250.-	1/6
	10		5SL42100RC	1250.-	1/6
	16		5SL42160RC	1250.-	1/6
	20		5SL42200RC	1250.-	1/6
	25		5SL42250RC	1250.-	1/6
	32		5SL42320RC	1250.-	1/6
	40		5SL42400RC	1450.-	1/6
	63		5SL42630RC	1450.-	1/6
3P, 415V AC 	2	3	5SL43020RC	2100.-	1/4
	4		5SL43040RC	2100.-	1/4
	6		5SL43060RC	1750.-	1/4
	10		5SL43100RC	1750.-	1/4
	16		5SL43160RC	1750.-	1/4
	20		5SL43200RC	1750.-	1/4
	25		5SL43250RC	1750.-	1/4
	32		5SL43320RC	1750.-	1/4
	40		5SL43400RC	2200.-	1/4
	63		5SL43630RC	2200.-	1/4
4P, 415V AC 	2	4	5SL44020RC	2275.-	1/3
	4		5SL44040RC	2275.-	1/3
	6		5SL44060RC	1975.-	1/3
	10		5SL44100RC	1975.-	1/3
	16		5SL44160RC	1975.-	1/3
	20		5SL44200RC	1975.-	1/3
	25		5SL44250RC	1975.-	1/3
	32		5SL44320RC	1975.-	1/3
	40		5SL44400RC	2480.-	1/3
	63		5SL44630RC	2480.-	1/3

Note:

\* MRP - Maximum Retail Price # 1MW (Module Width) = 18mm

\*\* Purchase MOQ for our authorised dealers is in multiples of standard packing, contact Siemens Sales Office for further details

## Betagard Circuit Breakers 5SY4, with C characteristics

- Standards: IEC/EN 60947-2
- Voltage: Un 230/400V
- Breaking capacity: 10kA as per IEC/EN 60947-2

### C characteristic

10000A		Rated Current I <sub>n</sub> (A)	MW#	Reference No	Unit MRP* ₹	Std. Pkg.** (Nos.)
	1Pole	80A	1	5SY41807CC	3625.-	1/1
	2Pole		2	5SY42807CC	7125.-	1/1
	3Pole		3	5SY43807CC	11120.-	1/1
	4Pole		4	5SY44807CC	15935.-	1/1

## Betagard Miniature Circuit Breakers 5SP4, with C/D characteristics



IS/IEC 60898 - 1





CM/L No. 2255548

- Standards: IS/IEC 60898-1:2002
- Voltage: Un 240/415V
- Breaking capacity: 10kA as per IS/IEC 60898-1:2002
- With ISI marking: CM/L No. 2255548

### C characteristic

10000A		Rated Current I <sub>n</sub> (A)	MW#	Reference No	Unit MRP* ₹	Std. Pkg.** (Nos.)
	1-pole	80	1.5	5SP41807RC	3430.-	1/10
		100		5SP41917RC	3620.-	1/10
		125		5SP41927RC	4105.-	1/10
	2-pole	80	3	5SP42807RC	6735.-	1/5
		100		5SP42917RC	7100.-	1/5
		125		5SP42927RC	8035.-	1/5
	3-pole	80	4.5	5SP43807RC	10515.-	1/1
		100		5SP43917RC	10790.-	1/1
		125		5SP43927RC	12365.-	1/1
	4-pole	80	6	5SP44807RC	15075.-	1/1
		100		5SP44917RC	15515.-	1/1
		125		5SP44927RC	17660.-	1/1

### D characteristic

	1-pole	80	1.5	5SP41808RC	3780.-	1/10
		100		5SP41918RC	3960.-	1/10
	2-pole	80	3	5SP42808RC	7580.-	1/5
		100		5SP42918RC	8040.-	1/5
	3-pole	80	4.5	5SP43808RC	11680.-	1/1
		100		5SP43918RC	11795.-	1/1
	4-pole	80	6	5SP44808RC	16425.-	1/1
		100		5SP44918RC	16845.-	1/1

Note:



\* MRP - Maximum Retail Price

# 1MW (Module Width) = 18mm

\*\* Purchase MOQ for our authorised dealers is in multiples of standard packing, contact Siemens Sales Office for further details

## Betagard Circuit Breakers 5SL5, DC with C Characteristics

- Standards: IS/IEC 60947-2
- Voltage: 220V DC/1P & 440VDC/2P ^
- Breaking capacity: 10kA as per IS/IEC 60947-2

10000A	Rated Current $I_n$ (A)	MW#	Reference No	Unit MRP* ₹	Std. Pkg.** (Nos.)
1P, 220V DC 	0.5	1	5SL51057RC	830.-	1/12
	1		5SL51017RC	830.-	1/12
	2		5SL51027RC	890.-	1/12
	3		5SL51037RC	940.-	1/12
	4		5SL51047RC	890.-	1/12
	6		5SL51067RC	760.-	1/12
	8		5SL51087RC	800.-	1/12
	10		5SL51107RC	760.-	1/12
	16		5SL51167RC	760.-	1/12
	20		5SL51207RC	760.-	1/12
	25		5SL51257RC	760.-	1/12
	32		5SL51327RC	760.-	1/12
	40		5SL51407RC	1135.-	1/12
	50		5SL51507RC	1135.-	1/12
63		5SL51637RC	1135.-	1/12	
2P, 440V DC 	0.5	2	5SL52057RC	1805.-	1/6
	1		5SL52017RC	1805.-	1/6
	2		5SL52027RC	1805.-	1/6
	3		5SL52037RC	1890.-	1/6
	4		5SL52047RC	1805.-	1/6
	6		5SL52067RC	1580.-	1/6
	8		5SL52087RC	1660.-	1/6
	10		5SL52107RC	1580.-	1/6
	16		5SL52167RC	1580.-	1/6
	20		5SL52207RC	1580.-	1/6
	25		5SL52257RC	1580.-	1/6
	32		5SL52327RC	1580.-	1/6
	40		5SL52407RC	2340.-	1/6
	50		5SL52507RC	2340.-	1/6
63		5SL52637RC	2340.-	1/6	



■ Stock items

^ For connection diagram, contact Siemens Sales Office for further details.

• Also available DC Circuit Breakers for Solar applications - contact Siemens sales office for further details.

## Betagard Isolators 5TL1

- Standard: IS/IEC 60947-3
- Voltage: 440V AC

	Rated Current $I_n$ (A)	MW#	Reference No	Unit MRP* ₹	Std. Pkg.** (Nos.)
 2-pole	32	2	5TL12320	715.-	1/1
	40		5TL12400	735.-	1/1
	63		5TL12630	970.-	1/1
	80		5TL12800	1270.-	1/1
	100		5TL12910	1615.-	1/1
	125		5TL12920	1675.-	1/1
 3-pole	32	3	5TL13320	1180.-	1/1
	40		5TL13400	1370.-	1/1
	63		5TL13630	1530.-	1/1
	80		5TL13800	1855.-	1/1
	100		5TL13910	1950.-	1/1
	125		5TL13920	2105.-	1/1
 4-pole	32	4	5TL14320	1350.-	1/1
	40		5TL14400	1605.-	1/1
	63		5TL14630	1825.-	1/1
	80		5TL14800	2195.-	1/1
	100		5TL14910	2640.-	1/1
	125		5TL14920	2865.-	1/1

Note:

\* MRP - Maximum Retail Price # 1MW (Module Width) = 18mm

\*\* Purchase MOQ for our authorised dealers is in multiples of standard packing, contact Siemens Sales Office for further details

**Betagard Circuit Breakers**  
**5SL5, 4-pole DC with C Characteristics**

**NEW**

- **Standards: IS/IEC 60947-2**
- **Voltage: 880V DC/4P<sup>^</sup>**
- **Breaking capacity: 10kA as per IS/IEC 60947-2**

10000A	Rated Current $I_n$ (A)	MW#	Reference No	Unit MRP* ₹	Std. Pkg.** (Nos.)
4P, 880V DC <sup>1)</sup>	6	4	5SL54067RC	3200.-	1/3
	10		5SL54107RC	3200.-	1/3
	16		5SL54167RC	3200.-	1/3
	25		5SL54257RC	3400.-	1/3
	32		5SL54327RC	3400.-	1/3
	40		5SL54407RC	4000.-	1/3
	63		5SL54637RC	4200.-	1/3



1) Maximum operational voltage 1000V DC

<sup>^</sup> For connection diagram, contact Siemens Sales Office for further details.

Note:

\* MRP - Maximum Retail Price # 1MW (Module Width) = 18mm

\*\* Purchase MOQ for our authorised dealers is in multiples of standard packing, contact Siemens Sales Office for further details



Kindly contact at [info@sbsyscon.in](mailto:info@sbsyscon.in) ( S B Syscon Pvt Ltd ) for best prices -  
Authorised Channel Partner for Siemens

**SIEMENS**



Celebrate Life, while we Care.



# Betagard 5SV

## Residual Current Circuit Breakers



In the event of a fault, residual current protective devices reliably disconnect power to protect humans

### Fault protection

“Protection against indirect contact”

Protects people in the event of contact with electrically conductive parts, if a risk exists as a result of a fault due to the magnitude or duration of the touch voltage



### Additional protection

“Protection in case of direct contact” with  $I_{\Delta n} = 30\text{mA}$

Protects individuals if they come in direct contact with an active live part under normal operating condition



### Fire protection

“Protection from insulation faults” with  $I_{\Delta n} = 300\text{mA}$

For the prevention of fires which can be caused by insulation faults in locations exposed to fire hazards



### Surge current withstand capability

“Protection surge currents” with  $8/20\mu\text{s} > 1000\text{Amp}$

For Type “A”  have a surge current capability to avoid nuisance tripping









## Betagard Residual Current Circuit Breakers 5SV

- Standards: IS 12640 (Part 1):2016/ IEC 61008-1:2012
- Voltage: 240/415VAC, 50Hz
- With ISI marking: CM/L No. 7676092

Type AC, applicable in networks for AC residual currents

		Rated residual current $I_{\Delta n}$ (mA)	Rated Current $I_n$ (A)	MW#	Reference No	Unit MRP* ₹	Std. Pkg.** (Nos.)
	2 Pole	30	25	2	■ 5SV43120RC	3655.-	1
		100	25		5SV44120RC	3815.-	1
		300	25		5SV46120RC	3945.-	1
		30	40		■ 5SV43140RC	4285.-	1
		100	40		5SV44140RC	4470.-	1
		300	40		5SV46140RC	4640.-	1
		30	63		■ 5SV43160RC	5730.-	1
		100	63		5SV44160RC	5770.-	1
		300	63		5SV46160RC	6135.-	1
		30	80		5SV43170RC	8860.-	1
		100	80		5SV44170RC	9210.-	1
		300	80		5SV46170RC	9210.-	1
			4 Pole		30	25	4
100	25			5SV44420RC	5075.-	1	
300	25			5SV46420RC	5265.-	1	
30	40			■ 5SV43440RC	4955.-	1	
100	40			5SV44440RC	5145.-	1	
300	40			5SV46440RC	5340.-	1	
30	63			■ 5SV43460RC	5770.-	1	
100	63			5SV44460RC	6000.-	1	
300	63			5SV46460RC	6215.-	1	
30	80			5SV43470RC	8860.-	1	
100	80			5SV44470RC	9210.-	1	
300	80			5SV46470RC	9210.-	1	

Type A, applicable in networks with AC and/or pulsating DC residual currents

	2 Pole	30	25	2	5SV33126RC	6685.-	1
		100	25		5SV34126RC	7875.-	1
		300	25		5SV36126RC	7875.-	1
		30	40		5SV33146RC	7580.-	1
		100	40		5SV34146RC	7895.-	1
		300	40		5SV36146RC	7895.-	1
		30	63		5SV33166RC	11025.-	1
		100	63		5SV34166RC	11335.-	1
		300	63		5SV36166RC	10795.-	1
		30	80		5SV33176RC	11860.-	1
		100	80		5SV34176RC	12755.-	1
		300	80		5SV36176RC	12145.-	1
			4 Pole		30	25	4
100	25			5SV34426RC	9785.-	1	
300	25			5SV36426RC	9785.-	1	
30	40			5SV33446RC	8755.-	1	
100	40			5SV34446RC	9785.-	1	
300	40			5SV36446RC	9785.-	1	
30	63			5SV33466RC	9995.-	1	
100	63			5SV34466RC	9935.-	1	
300	63			5SV36466RC	9935.-	1	
30	80			5SV33476RC	12015.-	1	
100	80			5SV34476RC	12755.-	1	
300	80			5SV36476RC	12145.-	1	

■ Stock items

Note:

\* MRP - Maximum Retail Price # 1MW (Module Width) = 18mm

\*\* Purchase MOQ for our authorised dealers is in multiples of standard packing, contact Siemens Sales Office for further details



## Betagard Residual Current Circuit Breakers 5SM3

- Standards: IS 12640 (Part 1):2016/ IEC 61008-1:2012
- Voltage: 240/415VAC, 50Hz
- With ISI marking: CM/L No. 7676092

Type AC, applicable in networks for AC residual currents

	Rated residual current $I_{\Delta n}$ (mA)	Rated Current $I_n$ (A)	MW#	Reference No	Unit MRP* ₹	Std. Pkg.** (Nos.)
	30	100	4	5SM33480RC	46225.-	1
	100	100		5SM34480RC	41010.-	1
	300	100		5SM36480RC	38880.-	1
	30	125		5SM33450RC	46225.-	1
	100	125		5SM34450RC	41010.-	1
	300	125		5SM36450RC	38880.-	1
	500	125		5SM37450RC	44770.-	1

Type A, applicable in networks with AC and/or pulsating DC residual currents

	30	100	4	5SM33486RC	42370.-	1
	100	100		5SM34486RC	40840.-	1
	300	100		5SM36486RC	41495.-	1
	30	125		5SM33456RC	42370.-	1
	100	125		5SM34456RC	40840.-	1
	300	125		5SM36456RC	45270.-	1
	500	125		5SM37456RC	46645.-	1

Note:

\* MRP - Maximum Retail Price # 1MW (Module Width) = 18mm

\*\* Purchase MOQ for our authorised dealers is in multiples of standard packing, contact Siemens Sales Office for further details

The right type for your application..

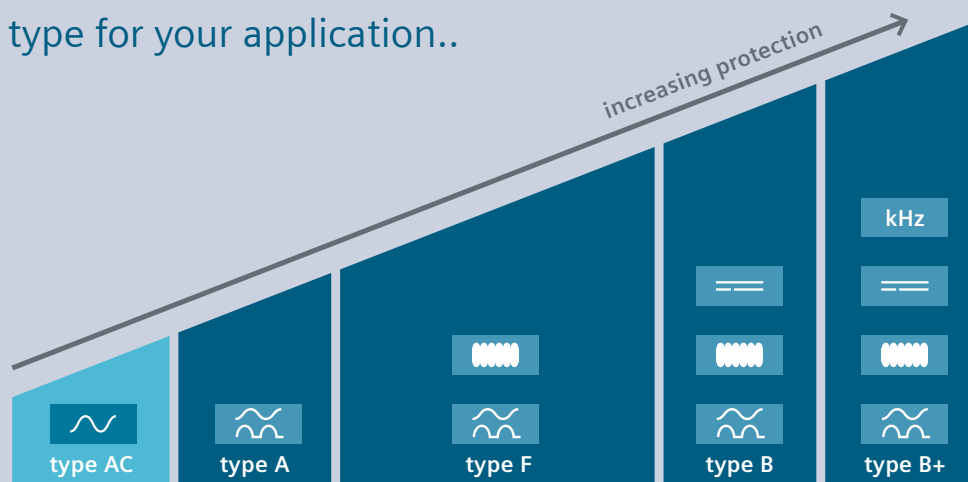

- sinusoidal alternating currents (type AC)
- pulsating DC residual currents (type A)

- electrical loads with frequency converters in the single-phase alternating currents (type F)

- smooth DC residual currents (type B/B+)

More information:  
[siemens.com/rccb](http://siemens.com/rccb)





## Betagard Residual Current Breaker Operators 5SU1, 10kA

- Standards: IS 12640, Part 2:2016/ IEC 61009-1:2012
- Voltage: 240/415Vac, 50Hz
- With ISI marking: CM/L No. 7676193



Type AC, with C Characteristics (in 2 module size)<sup>5</sup>

	Rated residual current $I_{\Delta n}$ (mA)	Rated Current $I_n$ (A)	MW <sup>#</sup>	Reference No	Unit MRP* ₹	Std. Pkg.** (Nos.)
	240Vac; 50Hz; 2 pole <sup>1)</sup>					
	30	6	2	5SU13541RC06	6330.-	1
	30	10		5SU13541RC10	6330.-	1
	30	16		5SU13541RC16	6330.-	1
	30	20		5SU13541RC20	6330.-	1
	30	25		5SU13541RC25	6330.-	1
	30	32		5SU13541RC32	6640.-	1
	30	40		5SU13541RC40	7855.-	1
	300	6		5SU16541RC06	6445.-	1
	300	10		5SU16541RC10	6445.-	1
	300	16		5SU16541RC16	6445.-	1
	300	20		5SU16541RC20	6445.-	1
	300	25		5SU16541RC25	6445.-	1
	300	32		5SU16541RC32	6775.-	1
300	40		5SU16541RC40	8010.-	1	

Type AC with C characteristic

	240Vac; 50Hz; 2 pole					
	30	32	4	5SU13241RC32	6250.-	1
		40		5SU13241RC40	7280.-	1
		63		5SU13241RC63	8465.-	1
	100	32		5SU14241RC32	6900.-	1
		40		5SU14241RC40	7750.-	1
		63		5SU14241RC63	9035.-	1
	300	32		5SU16241RC32	6970.-	1
		40		5SU16241RC40	7825.-	1
	63		5SU16241RC63	9035.-	1	
	415Vac; 50Hz; 4 pole					
	30	32	7	5SU13441RC32	8350.-	1
		40		5SU13441RC40	8500.-	1
		63		5SU13441RC63	10085.-	1
	100	32		5SU14441RC32	8450.-	1
		40		5SU14441RC40	8615.-	1
		63		5SU14441RC63	9900.-	1
	300	32		5SU16441RC32	8520.-	1
		40		5SU16441RC40	8685.-	1
	63		5SU16441RC63	9995.-	1	

Type AC with D characteristic

	240Vac; 50Hz; 2 pole					
	30	32	4	5SU13242RC32	8060.-	1
		40		5SU13242RC40	8830.-	1
		63		5SU13242RC63	10645.-	1
	100	32		5SU14242RC32	9755.-	1
		40		5SU14242RC40	10675.-	1
		63		5SU14242RC63	12190.-	1
	300	32		5SU16242RC32	9530.-	1
		40		5SU16242RC40	10675.-	1
	63		5SU16242RC63	12210.-	1	
	415Vac; 50Hz; 4 pole					
	30	32	7	5SU13442RC32	11040.-	1
		40		5SU13442RC40	11205.-	1
		63		5SU13442RC63	13290.-	1
	100	32		5SU14442RC32	11950.-	1
		40		5SU14442RC40	12480.-	1
		63		5SU14442RC63	13840.-	1
	300	32		5SU16442RC32	11800.-	1
		40		5SU16442RC40	12605.-	1
	63		5SU16442RC63	13550.-	1	

Note: \* MRP - Maximum Retail Price # 1MW (Module Width) = 18mm <sup>1)</sup> 1P+N variant

\*\* Purchase MOQ for our authorised dealers is in multiples of standard packing, contact Siemens Sales Office for further details

\$ For connecting accessories with 2P 2M RCBO add handle connector 5ST38051





## Betagard Residual Current Breaker Operators 5SU1, 10kA

- Standards: IS 12640, Part 2:2016/ IEC 61009-1:2012
- Voltage: 240/415Vac, 50Hz
- With ISI marking: CM/L No. 7676193



Type A, with C Characteristics (in 2 module size)<sup>5</sup>

	Rated residual current $I_{\Delta n}$ (mA)	Rated Current $I_n$ (A)	MW#	Reference No	Unit MRP* ₹	Std. Pkg.** (Nos.)
	240Vac; 50Hz; 2 pole <sup>1)</sup>					
	30	6	2	5SU13547RC06	11560.-	1
	30	10		5SU13547RC10	11560.-	1
	30	16		5SU13547RC16	11560.-	1
	30	20		5SU13547RC20	11560.-	1
	30	25		5SU13547RC25	11560.-	1
	30	32		5SU13547RC32	12085.-	1
	30	40		5SU13547RC40	14620.-	1
	300	6		5SU16547RC06	11900.-	1
	300	10		5SU16547RC10	11900.-	1
	300	16		5SU16547RC16	11900.-	1
	300	20		5SU16547RC20	11900.-	1
	300	25		5SU16547RC25	11900.-	1
	300	32		5SU16547RC32	12375.-	1
	300	40		5SU16547RC40	14925.-	1

Type A with C characteristic

	240Vac; 50Hz; 2 pole						
	30	32	4	5SU13247RC32	11325.-	1	
		40		5SU13247RC40	12460.-	1	
		63		5SU13247RC63	14095.-	1	
	100	32		5SU14247RC32	12085.-	1	
		40		5SU14247RC40	13425.-	1	
		63		5SU14247RC63	15255.-	1	
	300	32		5SU16247RC32	12085.-	1	
		40		5SU16247RC40	13425.-	1	
		63		5SU16247RC63	15255.-	1	
		415Vac; 50Hz; 4 pole					
		30	32	7	5SU13447RC32	13865.-	1
		40		5SU13447RC40	14435.-	1	
		63		5SU13447RC63	16515.-	1	
100		32		5SU14447RC32	14875.-	1	
		40		5SU14447RC40	15160.-	1	
		63		5SU14447RC63	16945.-	1	
300		32		5SU16447RC32	14875.-	1	
		40		5SU16447RC40	15420.-	1	
		63		5SU16447RC63	17210.-	1	

Type A with D characteristic

	240Vac; 50Hz; 2 pole						
	30	32	4	5SU13248RC32	13215.-	1	
		40		5SU13248RC40	14915.-	1	
		63		5SU13248RC63	16970.-	1	
	100	32		5SU14248RC32	14220.-	1	
		40		5SU14248RC40	15815.-	1	
		63		5SU14248RC63	18015.-	1	
	300	32		5SU16248RC32	14220.-	1	
		40		5SU16248RC40	15815.-	1	
		63		5SU16248RC63	18015.-	1	
		415Vac; 50Hz; 4 pole					
		30	32	7	5SU13448RC32	16360.-	1
		40		5SU13448RC40	16565.-	1	
		63		5SU13448RC63	19535.-	1	
100		32		5SU14448RC32	17230.-	1	
		40		5SU14448RC40	18415.-	1	
		63		5SU14448RC63	20050.-	1	
300		32		5SU16448RC32	17230.-	1	
		40		5SU16448RC40	18415.-	1	
		63		5SU16448RC63	20055.-	1	

Note: \* MRP - Maximum Retail Price

# 1MW (Module Width) = 18mm







<sup>1)</sup> 1P+N variant

\*\* Purchase MOQ for our authorised dealers is in multiples of standard packing, contact Siemens Sales Office for further details

\$ For connecting accessories with 2P 2M RCBO add handle connector 5ST38051

## Betagard Accessories

### Accessories for 5SL / 5SY / 5SP MCBs, 5TL isolators, 5SV/5SM RCCBs and 5SU1 RCBOs

	Item Description	Reference No	Unit MRP* ₹	Std. Pkg.** (Nos.)
	<b>Aux contact block</b> (For 5SL/5SY/5SP4/5TL/5SV/5SU1)			
	1NO+1NC	5ST3010	1325.-	12
	2NO	5ST3011	1350.-	1
	2NC	5ST3012	1350.-	1
	1CO	5ST3016	2105.-	1
	<b>Fault signal contact</b> (For 5SL/5SY/5SP4/5SV/5SU1)			
	1NO+1NC	5ST3020	1945.-	1
	2NO	5ST3021	1980.-	1
	2NC	5ST3022	1980.-	1
	<b>Shunt release</b> (For 5SL5/5SL7/5SY/5SP4/5SV/5SU1)			
	110...415V AC	5ST3030	5465.-	1/5
	24...48V DC	5ST3031	5465.-	1/5
	<b>Auxiliary and fault signal changeover contact</b> (For 5SL/5SY/5SP4/5TL/5SV/5SU1)	5ST3062	5970.-	1
	Auxiliary switch - 1CO Fault contact - 1CO			
	<b>Auxiliary contact block for 5SM3 100-125A 4pole</b>			
	1NO+1NC	5SW3330	5575.-	1/10
	<b>Undervoltage release</b> (For 5SL5/5SL7/5SY/5SP4/5SV/5SU1)			
	With integrated aux. switch			
	230V AC	5ST3040	7330.-	1/5
	110V DC	5ST3041	7330.-	1/5
	24V DC	5ST3042	7330.-	1/5
	Without integrated aux. switch			
	230V AC	5ST3043	7330.-	1/5
110V DC	5ST3044	7330.-	1/5	
	24V DC	5ST3045	7330.-	1/5
	Remote control mechanism unit			
	Basic version for 5SL,5SY,5TL1 and 5SU1 (1P+N only) (12-30)VAC & (12-48)VDC, 1.5MW	5ST3053	32710.-	1
	230VAC, 2MW	5ST3054	32710.-	1
	Power version for 5SL,5SY,5TL1 and 5SU1 (12-30)VAC & (12-48)VDC, 2MW	5ST3055	55350.-	1
	230VAC, 2MW	5ST3056	55350.-	1
	Adapter for Remote control mechanism (To be ordered along with 5ST305X basic unit)			
	For 5SL - 1P & 2P, 5SV - 4P	5ST38206	690.-	1
	For 5SL - 3P & 4P	5ST38207	690.-	1
	For 5SY - 1P & 2P and For 5SU1^ - 2P, 4M	5ST38201	690.-	1
	For 5SY - 3P & 4P and For 5SU1^ - 4P, 7M	5ST38202	690.-	1
For 5SU1 - 2P, 2M	5ST38205	690.-	1	
^ Add-on block for 5SU1 to be ordered along with Adapter	5ST38203	1505.-	1	
	<b>Handle locking device</b>			
	for 5SP and 5SY circuit breakers for padlock with max. 3mm shackle	5ST3801	675.-	1
	for 5SL circuit breakers, 5TL1 isolators and 5SV residual current circuit breakers for padlock with max. 3 to 6 mm shackle	5ST3806	645.-	5
	Pad locks for 5ST3801 and 5ST3806 handle locking devices	5ST3802	435.-	5
	Handle connector for 2P, 2M 5SU1 RCBO <sup>5</sup>	5ST38051	1355.-	1

### Betagard Rotary Handle Assembly

	Item Description	Reference No.	Unit MRP* ₹	Std. Pkg.** (Nos.)
	Rotary Handle Assembly for 5SY, 5SL, 5SP and 5TL1 series of MCBs/ Isolators <sup>55</sup>	5ST38140RC	2430.-	1

Note: \* MRP - Maximum Retail Price # 1MW (Module Width) = 18mm

\$ For 2P, 2M RCBOs, the accessories can be used along with Handle connector only

\$\$ Not suitable for 1P variants

\*\* Purchase MOQ for our authorised dealers is in multiples of standard packing, contact Siemens Sales Office for further details

Kindly contact at [info@sbsyscon.in](mailto:info@sbsyscon.in) ( S B Syscon Pvt Ltd ) for best prices -  
Authorised Channel Partner for Siemens



# | SIRENEW

Power Distribution Solution  
for RENEWables

[www.siemens.co.in](http://www.siemens.co.in)

**SIEMENS**

thanks to



technology

## World's smallest AFDD

Thanks to innovative SIARC technology, the AFDD is the only protection device that detects parallel as well as serial arcing faults. Common causes are, among others:

First arc fault detection device (AFDD) in the IEC market (2012) for preventive fire protection  
First AFDD with integrated MCB in 1 modular width (MW)

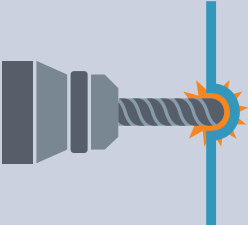

damaged wire insulation



crushed cables

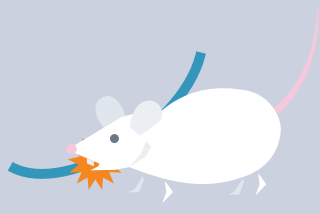

rodent damage

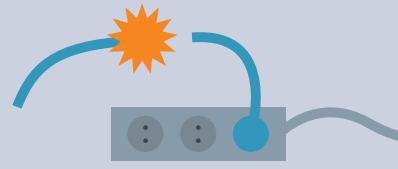

broken cables

# #1 Be the first to play it safe with the 5SV6 AFDD

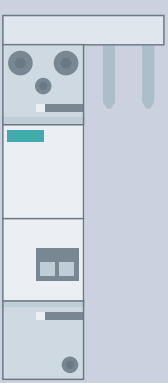

Arc fault detection unit

+



Miniature circuit breaker

=

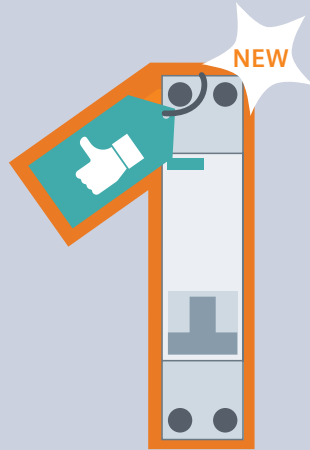

5SV6 AFDD

1 MW



# AFDDs are strongly recommended!

## Comprehensive portfolio for preventive fire protection

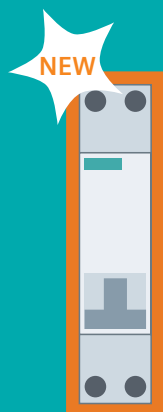

**5SV6 AFDD**  
+ integrated MCB = 1 MW

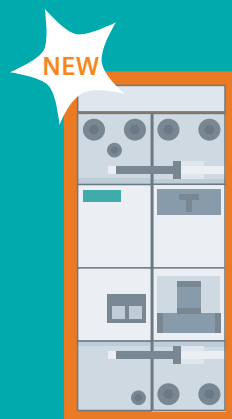

**5SM6 AFD unit**  
+ 5SV1 RCBO = 2 MW



**5SM6 AFD unit**  
+ 5SY60 MCB = 2 MW

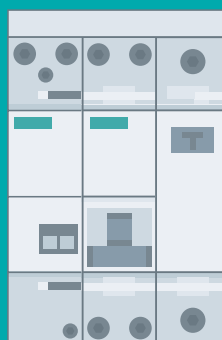

**5SM6 AFD unit**  
+ 5SU1 RCBO = 3 MW

More information available at [siemens.com/afdd](http://siemens.com/afdd)

### It's Time to Act Now!

## Preventive, Proven, Standard compliant

Kindly contact at [info@sbsyscon.in](mailto:info@sbsyscon.in) ( S B Syscon Pvt Ltd ) for best prices -  
Authorised Channel Partner for Siemens

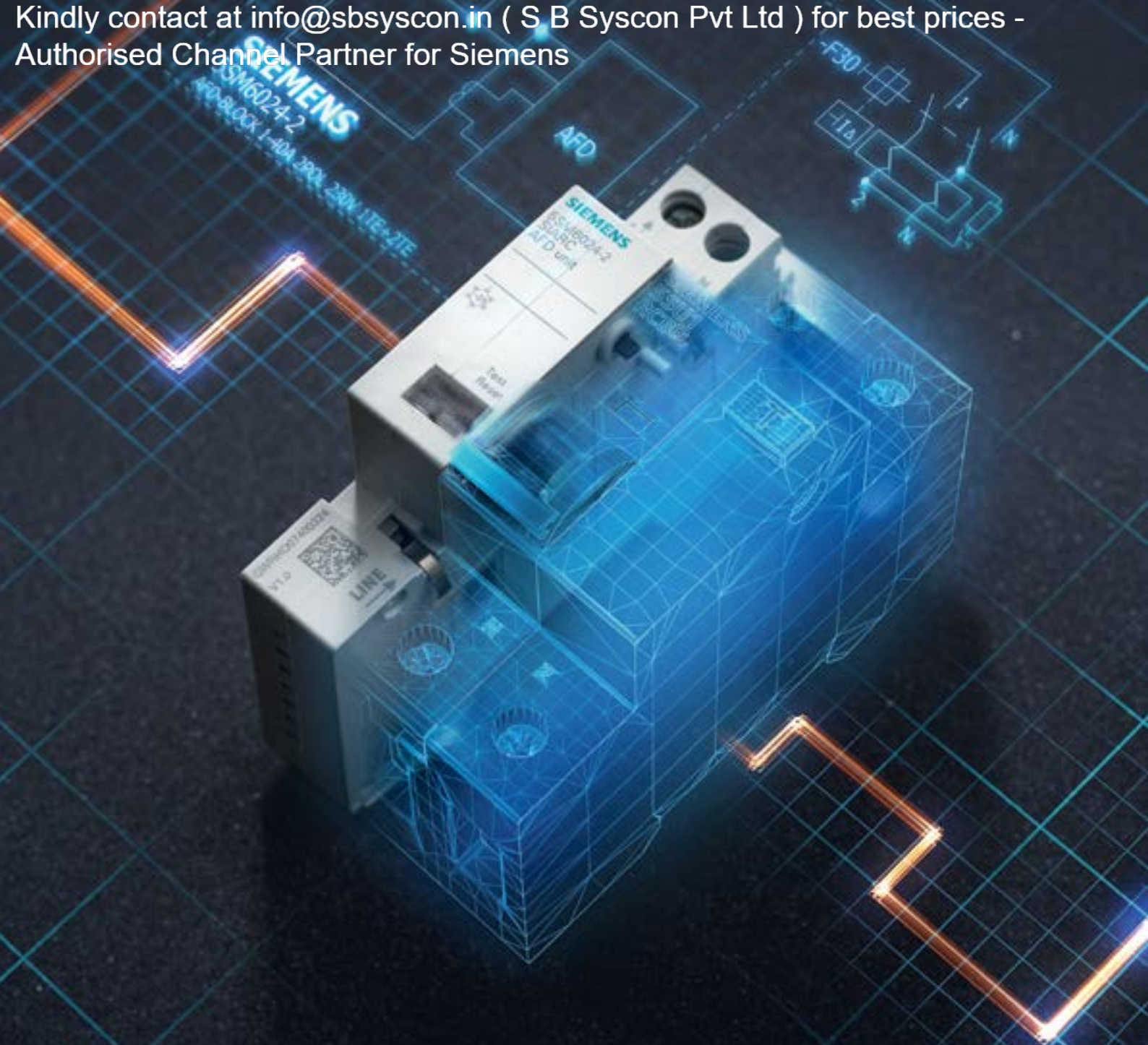

# | Arc Fault Detection Device

## It's Time to Act Now!

With the 5SV6 Arc Fault Detection Device (AFDD), Siemens presents the third generation of fire-prevention product. The 5SV6 Arc Fault Detection Device with integrated miniature circuit breaker (MCB) is the first device on the IEC market with just one module width and is the smallest of its kind worldwide.

A standard-compliant expansion of the electrical installation by protection against electrical fires is thus always possible – easily and without the need for additional space.

[www.siemens.com/afd-units](http://www.siemens.com/afd-units)

**SIEMENS**

**NEW**



## The smart solution.

Whether in an existing plant or a new installation – the 5SV6 AFDD and 5SM6 AFD unit can be deployed in any distribution board. It quickly identifies dangerous faults caused by parallel or serial arcing faults and switches off before a fire occurs. The AFDD detects operational arcing faults and only trips in the event of an actual fault.

### 5SV6 AFDDs with Integrated MCB & RCBO in 18mm width



Rating	With integrated MCB		With integrated RCBO	Unit LP* ₹
	B characteristic	C characteristic	30mA, Type AC, C characteristic	
6A	5SV60166KK06	5SV60167KK06	5SV63167KK06	Price on Request
10A	5SV60166KK10	5SV60167KK10	5SV63167KK10	
13A	5SV60166KK13	5SV60167KK13	5SV63167KK13	
16A	5SV60166KK16	5SV60167KK16	5SV63167KK16	
20A	5SV60166KK20	5SV60167KK20	5SV63167KK20	
25A	5SV60166KK25	5SV60167KK25	5SV63167KK25	
32A	5SV60166KK32	5SV60167KK32	5SV63167KK32	
40A	5SV60166KK40	5SV60167KK40	5SV63167KK40	

### 5SM6 AFDD with integrated MCB



Rating	Module width	Reference No.	Description	Unit LP* ₹
16A	2	5SM60111XX02	AFDD 16A, 230V, 2MW (Integrated with 1MW, 1+N, 16A MCB)	Price on Request

### 5SM6 AFD units (Suitable for add on with RCBO)



Rating	Module width	Reference No.	Description	Unit LP* ₹
16A	3	5SM60212	AFD Unit 1-16A, 230V, 1MW (Suitable for 2P 2M, 5SU1 RCBO)	Price on Request
40A	3	5SM60242	AFD Unit 1-40A, 230V, 1MW (Suitable for 2P 2M, 5SU1 RCBO)	

\* LP - List Price

Arc Fault Detection Devices

Kindly contact at [info@sbsyscon.in](mailto:info@sbsyscon.in) ( S B Syscon Pvt Ltd ) for best prices -  
Authorised Channel Partner for Siemens



# Betagard 8GB Distribution Boards

Perfect blend of beauty and features with assured performance



- Complete range for Residential, Commercial and Industrial Infrastructures
- DBs offer latest design with highest aesthetic appeal
- DBs available with type testing as per the latest applicable standards
- User friendly design offers ease during maintenance and assists the installer for correct installation

[www.siemens.co.in](http://www.siemens.co.in)

**SIEMENS**

## Betagard Distribution Boards 8GB32 # SPN and TPN DBs

- Type Tested as per IEC 61439 Standards at third party and internal test laboratories
- Available in IP 20 and IP 43 Versions
- Single Door, Metal Double Door and Acrylic Double Door options available
- Standard Wire Way Boxes available for all Single Door and Double Door DBs
- Additional safety with Insulated Shorting Links, Shrouded Neutral Links and Door Earthing
- TPN DBs can be easily made suitable for PPI configuration using TPN to PPI Conversion Kits
- Detachable DIN rail assembly and intermittent door facilitates ease in Wiring during installation and maintenance
- DBs are subjected to Seven tank process and treated with premium quality powder coating
- Cement Masking Sheet protects the DBs against extreme site conditions

	Item Description	Incoming Slots (MW)	Outgoing Slots (MW)	Total Slots (MW)	Reference No	Unit MRP* ₹	Std. Pkg.** (Nos.)
<b>Metal Enclosures, IP20:</b>							
	1 Module	-	-	1	8GB32100RC01	660.-	1/20
	2 Module	-	-	2	8GB32100RC02	980.-	1/20
	3 Module	-	-	3	8GB32100RC03	980.-	1/20
	4 Module	-	-	4	8GB32100RC04	980.-	1/20
	6 Module	-	-	6	8GB32100RC06	1295.-	1/20
	8 Module	-	-	8	8GB32100RC08	1525.-	1/10
<b>SPN Single Door DBs#, IP20:</b>							
	6 Module	2	4	6	8GB32101RC06	1940.-	1
	8 Module	2	6	8	8GB32101RC08	2060.-	1
	10 Module	2	8	10	8GB32101RC10	2480.-	1
	12 Module	2	10	12	8GB32101RC12	2570.-	1
	14 Module	2	12	14	8GB32101RC14	2905.-	1
	16 Module	2	14	16	8GB32101RC16	3130.-	1
<b>SPN Metal Double Door DBs#, IP 43:</b>							
	6 Module	2	4	6	8GB32102RC06	3030.-	1
	8 Module	2	6	8	8GB32102RC08	3145.-	1
	10 Module	2	8	10	8GB32102RC10	3665.-	1
	12 Module	2	10	12	8GB32102RC12	3760.-	1
	14 Module	2	12	14	8GB32102RC14	4380.-	1
	16 Module	2	14	16	8GB32102RC16	4490.-	1
<b>SPN Acrylic Double Door DBs#, IP 43:</b>							
	6 Module	2	4	6	8GB32103RC06	3560.-	1
	8 Module	2	6	8	8GB32103RC08	3760.-	1
	10 Module	2	8	10	8GB32103RC10	4380.-	1
	12 Module	2	10	12	8GB32103RC12	4705.-	1
	14 Module	2	12	14	8GB32103RC14	4910.-	1
	16 Module	2	14	16	8GB32103RC16	5120.-	1
<b>Wire Way Box For SPN Single Door IP 20 DBs:</b>							
	For 6 MOD SPN Single door DB	-	-	-	8GB32106RC06	1275.-	1/5
	For 8 MOD SPN Single door DB	-	-	-	8GB32106RC08	1275.-	1/5
	For 10 MOD SPN Single door DB	-	-	-	8GB32106RC10	1375.-	1/5
	For 12 MOD SPN Single door DB	-	-	-	8GB32106RC12	1375.-	1/5
	For 14 MOD SPN Single door DB	-	-	-	8GB32106RC14	1585.-	1/5
	For 16 MOD SPN Single door DB	-	-	-	8GB32106RC16	1585.-	1/5
<b>Wire Way Box For SPN Double Door IP 43 DBs:</b>							
	For 6 MOD SPN Double door DB	-	-	-	8GB32107RC06	1375.-	1/5
	For 8 MOD SPN Double door DB	-	-	-	8GB32107RC08	1375.-	1/5
	For 10 MOD SPN Double door DB	-	-	-	8GB32107RC10	1490.-	1/5
	For 12 MOD SPN Double door DB	-	-	-	8GB32107RC12	1490.-	1/5
	For 14 MOD SPN Double door DB	-	-	-	8GB32107RC14	1900.-	1/5
	For 16 MOD SPN Double door DB	-	-	-	8GB32107RC16	1900.-	1/5

Note: \* MRP - Maximum Retail Price # Also available in flat door option

For Customized Solutions in Distribution Boards please Contact our sales Office

\*\* Purchase MOQ for our authorised dealers is in multiples of standard packing, contact Siemens Sales Office for further details

**Betagard Distribution Boards**  
**8GB32 # SPN and TPN DBs**

	Item Description	Incoming Slots (MW)	Outgoing Slots (MW)	Total Slots (MW)	Reference No	Unit MRP* ₹	Std. Pkg.** (Nos.)
<b>TPN Single Door DBs#, IP20:</b>							
	4 way	8	12	20	8GB32201RC04	4875.-	1
	6 way	8	18	26	8GB32201RC06	5535.-	1
	8 way	8	24	32	8GB32201RC08	6685.-	1
	10 way	8	30	38	8GB32201RC10	9695.-	1
	12 way	8	36	44	8GB32201RC12	9900.-	1
	14 way	8	42	50	8GB32201RC14	11355.-	1
	16 way	8	48	56	8GB32201RC16	11780.-	1
<b>TPN Metal Double Door DBs#, IP 43</b>							
	4 way	8	12	20	8GB32202RC04	5955.-	1
	6 way	8	18	26	8GB32202RC06	7200.-	1
	8 way	8	24	32	8GB32202RC08	8655.-	1
	10 way	8	30	38	8GB32202RC10	12505.-	1
	12 way	8	36	44	8GB32202RC12	12815.-	1
	14 way	8	42	50	8GB32202RC14	15210.-	1
	16 way	8	48	56	8GB32202RC16	15640.-	1
<b>TPN Acrylic Double Door DBs#, IP 43</b>							
	4 way	8	12	20	8GB32203RC04	7200.-	1
	6 way	8	18	26	8GB32203RC06	8865.-	1
	8 way	8	24	32	8GB32203RC08	10630.-	1
	10 way	8	30	38	8GB32203RC10	13870.-	1
	12 way	8	36	44	8GB32203RC12	16140.-	1
	14 way	8	42	50	8GB32203RC14	17290.-	1
	16 way	8	48	56	8GB32203RC16	18450.-	1
<b>TPN to PPI Conversion Kit®</b>							
	To convert 6 way TPN DB to 4 way TPN PPI DB				8GB32205RC04	3760.-	1/5
	To convert 8 way TPN DB to 6 way TPN PPI DB				8GB32205RC06	4380.-	1/5
	To convert 10 way TPN DB to 8 way TPN PPI DB				8GB32205RC08	4490.-	1/5
	To convert 12 way TPN DB to 10 way TPN PPI DB				8GB32205RC10	4800.-	1/5
	To convert 14 way TPN DB to 12 way TPN PPI DB				8GB32205RC12	5120.-	1/5
	To convert 16 way TPN DB to 14 way TPN PPI DB				8GB32205RC14	5420.-	1/5
	<b>Wire Way Box For TPN Single Door IP 20 DBs</b>						
	For 4 Way TPN Single door DB	-	-	-	8GB32206RC04	1585.-	1/5
	For 6 Way TPN Single door DB	-	-	-	8GB32206RC06	1585.-	1/5
	For 8 Way TPN Single door DB	-	-	-	8GB32206RC08	2830.-	1/5
	For 10 Way TPN Single door DB	-	-	-	8GB32206RC10	3560.-	1/5
	For 12 Way TPN Single door DB	-	-	-	8GB32206RC12	3665.-	1/5
	For 14 Way TPN Single door DB	-	-	-	8GB32206RC14	3760.-	1/5
	For 16 Way TPN Single door DB	-	-	-	8GB32206RC16	3980.-	1/5
<b>Wire Way Box For TPN Double Door IP 43 DBs</b>							
	For 4 Way TPN Double door DB	-	-	-	8GB32207RC04	1685.-	1/5
	For 6 Way TPN Double door DB	-	-	-	8GB32207RC06	1900.-	1/5
	For 8 Way TPN Double door DB	-	-	-	8GB32207RC08	3030.-	1/5
	For 10 Way TPN Double door DB	-	-	-	8GB32207RC10	3245.-	1/5
	For 12 Way TPN Double door DB	-	-	-	8GB32207RC12	3980.-	1/5
	For 14 Way TPN Double door DB	-	-	-	8GB32207RC14	4180.-	1/5
	For 16 Way TPN Double door DB	-	-	-	8GB32207RC16	4300.-	1/5

Note: \* MRP - Maximum Retail Price

@ Contains required accessories to Make the DB suitable for PPI Configuration  
 For Customized Solutions in Distribution Boards please Contact our sales Office

\*\* Purchase MOQ for our authorised dealers is in multiples of standard packing, contact Siemens Sales Office for further details

# Also available in flat door option

## Betagard Distribution Boards 8GB32 TPN Phase Segregated DBs

Item Description	Incoming Slots (MW)	Sub-Incomer Slots (MW)	Outgoing Slots (MW)	Total Slots (MW)	Reference No	Unit MRP* ₹	Std. Pkg.** (Nos.)
<b>TPN Phase segregated DBs, IP 20 For MCB as incomer</b>							
4 Way	12	12	12	36	8GB32001RC04	13430.-	1
6 Way	12	12	18	42	8GB32001RC06	15105.-	1
8 Way	12	12	24	48	8GB32001RC08	17630.-	1
12 Way	12	12	36	60	8GB32001RC12	20990.-	1
<b>TPN Phase segregated DBs, (8 segment) IP 43 For MCB as incomer</b>							
4 way	12	12	12	36	8GB32002RC04	15950.-	1
6 way	12	12	18	42	8GB32002RC06	18470.-	1
8 way	12	12	24	48	8GB32002RC08	20990.-	1
12 way	12	12	36	60	8GB32002RC12	25185.-	1
<b>TPN Phase segregated DBs, IP 43 for MCCB as incomer upto 160A</b>							
6 way		12	18	30	8GB32012RC06	28530.-	1
8 way		12	24	36	8GB32012RC08	32735.-	1
12 way		12	36	48	8GB32012RC12	36930.-	1
<b>Wire Way box for MCB Incomer, IP 43 DBs</b>							
For 4 Way	-	-	-	-	8GB32007RC04	4190.-	1
For 6 Way	-	-	-	-	8GB32007RC06	5030.-	1
For 8 Way	-	-	-	-	8GB32007RC08	5870.-	1
For 12 Way	-	-	-	-	8GB32007RC12	6705.-	1
<b>Wire Way box for MCCB Incomer, IP 43 DBs</b>							
For 6 Way	-	-	-	-	8GB32017RC06	5030.-	1
For 8 Way	-	-	-	-	8GB32017RC08	5870.-	1
For 12 Way	-	-	-	-	8GB32017RC12	6705.-	1

## Betagard Distribution Board 8GB

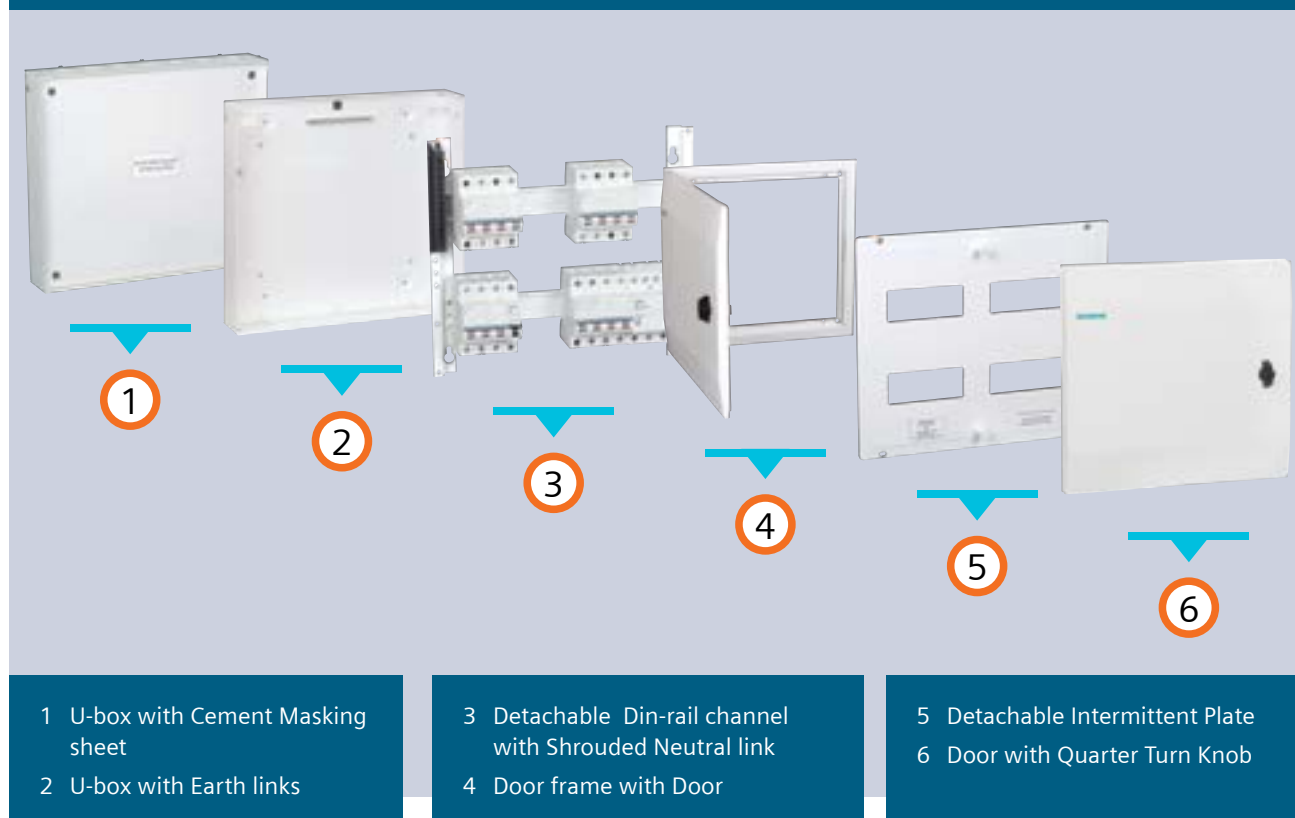

- 1 U-box with Cement Masking sheet
- 2 U-box with Earth links

- 3 Detachable Din-rail channel with Shrouded Neutral link
- 4 Door frame with Door

- 5 Detachable Intermittent Plate
- 6 Door with Quarter Turn Knob

Note: \* MRP - Maximum Retail Price

\*\* Purchase MOQ for our authorized dealers is in multiples of standard packing, contact Siemens Sales Office for further details

## Industrial plug & sockets

	Item Description	Total Slots (MW)	Reference No	Unit MRP* ₹	Std. Pkg.** (Nos.)
<b>Plug &amp; Socket, IP20 with provision for MCB mounting :</b>					
	1 Phase 20A, 1P MCB	1	8GB0501RC	2175.-	1/20
	1 Phase 20A, 2P MCB	2	8GB0501SRC	2175.-	1/20
	3 Phase 32A, 3P MCB	3	8GB0502	4615.-	1/15
	3 Phase 32A, 3P+N MCB	4	8GB0502S	4615.-	1/15
	5 Pin (3P+N+PE) 3Phase 32A MCB 3P+N MCB	8	8GB050332	7285.-	1/5
	5 Pin (3P+N+PE) 3Phase 63A MCB 3P+N MCB	8	8GB050363	18985.-	1/5

## Simbox WP

	Item Description	Total Slots (MW)	Reference No	Unit MRP* ₹	Std. Pkg.** (Nos.)
<b>Simbox WP (IP65 DBs)</b>					
	1 Row, 4Mod	4	8GB13710	6555.-	1
	1 Row 8Mod	8	8GB13711	8325.-	1
	1 Row 12Mod	12	8GB13712	14865.-	1
	1 Row 18Mod	18	8GB13713	19250.-	1
	2 Row 2 x 12Mod	24	8GB13722	23765.-	1
	2 Row, 2 x 18Mod	36	8GB13723	33510.-	1
	3 Row, 3 x 18Mod	54	8GB13733	58925.-	1
	4 Row 4 x 18Mod	72	8GB13743	77210.-	1

### Accessories for Simbox WP

	Coupling covers, 12M		8GB20510	2145.-	1
	Coupling covers, 18M		8GB20511	2405.-	1
	Insulated N/PE terminals, 8MW		8GB20520	3340.-	1
	Insulated N/PE terminals, 12MW		8GB20521	5110.-	1
	Insulated N/PE terminals, 18MW		8GB20522	7510.-	1
	Cylindrical security lock		8GB20550	6095.-	1

Note: \* MRP - Maximum Retail Price









For Customized Solutions in Distribution Boards please Contact our sales Office

\*\* Purchase MOQ for our authorised dealers is in multiples of standard packing, contact Siemens Sales Office for further details





## Betagard Distribution Boards Accessories

	Item Description	Reference No	Unit MRP* ₹	Std. Pkg.** (Nos.)
<b>Blanking Plate</b>				
	1 MW	8GB9901	80.-	25
	1.5 MW	8GB9902	90.-	25
<b>Insulated Shorting Links</b>				
<b>Single Phase Shorting Links for Shorting 1P MCBs</b>				
<b>For SPN and TPN PPI DB</b>				
	5 Leg SP Shorting Link	8GB9905LSP	255.-	10
	7 Leg SP Shorting Link	8GB9907LSP	300.-	10
	9 Leg SP Shorting Link	8GB9909LSP	350.-	10
	11 Leg SP Shorting Link	8GB9911LSP	370.-	10
	13 Leg SP Shorting Link	8GB9913LSP	490.-	10
	15 Leg SP Shorting Link	8GB9915LSP	600.-	10
	17 Leg SP Shorting Link	8GB9917LSP	625.-	10
<b>For TPN DB</b>				
	4 Leg SP Shorting Link	8GB9904LSP	255.-	10
	6 Leg SP Shorting Link	8GB9906LSP	300.-	10
	8 Leg SP Shorting Link	8GB9908LSP	350.-	10
	10 Leg SP Shorting Link	8GB9910LSP	370.-	10
	12 Leg SP Shorting Link	8GB9912LSP	490.-	10
	14 Leg SP Shorting Link	8GB9914LSP	600.-	10
	16 Leg SP Shorting Link	8GB9916LSP	625.-	10
<b>Two Phase, 1 meter long for shorting 2P MCBs (suitable for maximum of 28 nos. 2MW devices)</b>				
	Shorting link without End caps, Can be cut and used.	8GB990SLDLP	6215.-	1
	End Caps for 2 pole Shorting Links	8GB990ECLDP	105.-	10
<b>Three Phase, 1 meter long for shorting 3P MCBs (suitable for maximum of 19 nos. 3MW devices)</b>				
	Shorting link without Enc caps, Can be cut and used.	8GB990SLLTP	6795.-	1
	End Caps for 3 pole Shorting Links	8GB990ECLTP	150.-	10
<b>Three Phase + N, 1 meter long for shorting TPN MCBs (suitable for maximum of 14 nos. 4MW devices)</b>				
	Shorting link without Enc caps, Can be cut and used.	8GB990SLLTPN	7180.-	1
	End Caps for 3 pole Shorting Links	8GB990ECLTPN	190.-	10
<b>Neutral Terminals</b>				
<b>Neutral Terminals For 8GB0 and 8GB31 DBs (Along with Mounting Stands)</b>				
	5 Way Neutral Link	8GB9905NL	270.-	10
	11 Way Neutral Link	8GB9911NL	405.-	10
	13 Way Neutral Link	8GB9913NL	465.-	10
	15 Way Neutral Link	8GB9915NL	520.-	10
<b>Neutral Terminals For 8GB32 DBs (With Terminal Shroud and Cover)</b>				
	Neutral Terminal 5 Holes	8GB9905NPE	300.-	10
	Neutral Terminal 11 Holes	8GB9911NPE	415.-	10
	Neutral Terminal 13 Holes	8GB9913NPE	490.-	10
	Neutral Terminal 15 Holes	8GB9915NPE	545.-	10
<b>Earth Terminals</b>				
	5 Way Earth Link	8GB9905EL	230.-	10
	11 Way Earth Link	8GB9911EL	390.-	10
	13 Way Earth Link	8GB9913EL	415.-	10
	15 Way Earth Link	8GB9915EL	490.-	10

Note: \* MRP - Maximum Retail Price

\*\* Purchase MOQ for our authorised dealers is in multiples of standard packing, contact Siemens Sales Office for further details

Kindly contact at [info@sbsyscon.in](mailto:info@sbsyscon.in) ( S B Syscon Pvt Ltd ) for best prices -  
Authorised Channel Partner for Siemens



# 5SD Surge Protection Devices

## Safe & Reliable

Surge Protection Devices are available in the following types:

Type 1 - For incoming power supply panels, in buildings with lightning protection system. Must be accompanied by downstream SPD

Type 2 - For distribution panels located downstream of Type 1 protectors or in incoming supply panels in areas of low exposure to lightning strikes, where the building is not fitted with lightning protection system

Type 3 - Always installed downstream of Type 2 protection designed to protect sensitive equipment or equipment located more than 20m downstream of Type 2 SPD

[www.siemens.co.in](http://www.siemens.co.in)

**SIEMENS**

## Surge Protection Devices

For protection of equipment against Lightning and Switching surges

- Standard: IEC 61643-11 / EN 61643-11
- Type 1, Type 2 and Photovoltaic surge protection
- With Remote signaling contact
- Integrated SPD health indicator

### Type 1: Lightning Surge Arresters

- Maximum continuous operating voltage  $U_c$ : 350V



Reference No.	Rated voltage	Pole	Module width	Total $I_{imp}$ (10/350 $\mu$ s)	$I_{max}$ (8/20 $\mu$ s)	Remote status	Unit LP* ₹
5SD74121RC	240V AC	1P+N	4	50kA	50kA	Yes	19800.-
5SD74141RC	240/415V AC	3P+N	8	100kA	50kA	Yes	38545.-

### Type 2: Surge Arresters



Reference No.	Rated voltage	Pole	Module width	$U_c$	$I_{max}$ (8/20 $\mu$ s)	Remote status	Unit LP* ₹
5SD74610RC	240V AC	1P	1	335V AC	20kA	No	3240.-
5SD74640RC	240/415V AC	3P+N	4	335V AC	40kA	No	9625.-

### Surge Arresters for Photovoltaic application

On the DC side, over voltage protection is required for the inverters which can be ensured by using 5SD74836RC.

On the AC side, the over voltage protection can be ensured using surge arresters Type 2 (5SD7461-ORC/5SD7464-ORC)



Reference No.	Rated voltage	Pole	Module width	$U_{cpv}$	$I_{max}$ (8/20 $\mu$ s)	Remote status	Unit LP* ₹
5SD74836RC	1170V DC	L+ and L-	3	1170V DC	40kA	No	5465.-

Note: Standard packing: 1 unit

\*LP: List Price



## Surge Protection Devices

For protection of equipment against Lightning and Switching surges

### Type 1: Lightning Surge Arresters

#### For TN-S/ TT system

Lightning arresters, Type 1 requirement class B,  $U_c$  350V Pluggable protective modules 4-pole,  
 3+1 circuit for TN-S and TT systems with remote display



5SD74121



5SD74141

Rated voltage $U_N$	Backup fuse rating	Protection level	Lightening impulse current $I_{mp}(10/350\mu s)$		Pole	Reference No.	Unit LP* ₹
			L-N or L-(PE), 1P/3P	N-PE			
240V AC	125A gL/gG	1.5-2.5kV	25kA	100kA	1P+N	5SD74121	Price on request
240/415V AC	125A gL/gG	1.5-2.5kV	25kA/75kA	100kA	3P+N	5SD74141	

#### For TN-C system

Lightning arresters, Type 1 requirement class B,  $U_c$  350V Pluggable protective modules 3-pole,  
 3+0 circuit for TNC systems with remote display



5SD74131

Rated voltage $U_N$	Backup fuse rating	Protection level	Lightening impulse current $I_{mp}(10/350\mu s)$		Pole	Reference No.	Unit LP* ₹
			L-N or L-(PE), 1P/3P	N-PE			
240/415V AC	125A gL/gG	$\leq 1.5kV$	25kA/75kA	-	3P	5SD74131	67110.-

### Type 2 : Surge Arresters

#### For TN-S/ TT system

Surge arrester Type 2 requirement class C,  $U_c$ :350V/260V (L-N/N-PE) Pluggable protective modules 4-pole,  
 3+1 circuit for TN-S and TT AC systems

Rated Discharge Surge Current  $I_n=20kA$

SC capacity with backup fuse=25kA



5SD74641



5SD7422-0

Rated voltage $U_N$	Backup fuse rating	Protection level $U_p$	Rated discharge current $I_n$ (8/20usec)		Pole	Remote signaling	Reference No.	Unit LP* ₹
			L-N or L-(PE), 1P/3P	N-PE				
240/415V	80A gL/gG	1.5-1.9kV	40kA	40kA	3P+N	No	5SD74640	Price on request
240/415V	80A gL/gG	1.5-1.9kV	40kA	40kA	3P+N	Yes	5SD74641	
240V	80A gL/gG	1.5-1.9kV	20kA	20kA	1P+N	No	5SD74220	
240V	80A gL/gG	1.5-1.9kV	20kA	20kA	1P+N	Yes	5SD74221	

#### For TN-C system

Surge arrester Type 2 requirement class C,  $U_c$ :350V  
 Pluggable protective modules 3-pole, 3+0 circuit for TNC systems



5SD7463-0

Rated voltage $U_N$	Backup fuse rating	Protection level $U_p$	Maximum discharge surge current $I_{max}$ L-N or L-(PE)N, 1P		Pole	Remote signaling	Reference No.	Unit LP* ₹
			L-N or L-(PE)N, 1P	N-PE				
240/415V	80A gL/gG	$\leq 1.5kV$	40kA		3P	No	5SD74630	30595.-
240/415V	80A gL/gG	$\leq 1.5kV$	40kA		3P	Yes	5SD74631	20465.-

L - Line, N - Neutral, PE - Protective Earth

Note: Standard packing: 1unit

\* LP : List Price

## Surge Protection Devices

For protection of equipment against Lightning and Switching surges

### Type 3 : Surge Arresters



Rated voltage	Rated current	Protection level	Rated discharge current	Pole	Reference No.	Unit LP* ₹
24V AC 34V DC	26A	0.65kV	1kA	2P	5SD74325	13295.-
120V AC 150V DC	26A	0.95kV	3kA	2P	5SD74326	14485.-
240V AC 240V DC	26A	1.5kV	3kA	2P	5SD74327	14870.-

### Surge arresters for photovoltaic application

Due to the combination of three power varistors, the overvoltage protection required for the inverters is implemented on the DC side. On the AC side, the overvoltage protection can be ensured using surge arresters type 2 (5SD7422-/5SD7424-)



5SD74836

Rated voltage U <sub>N</sub>	Rated discharge current	Protection level U <sub>p</sub>	Lightning Impulse current (L-N/L-(PE)N)	Max. discharge current	Pole	Remote signaling	Reference No.	Unit LP* ₹
1000V DC	15kA	≤3.5kV	≤5kA	40kA	3P	No	5SD74836	Price on request

### Replacement Plug



SPD Type	Type	Connection	Reference No.	Unit LP* ₹
5SD74121	Type 1	L-N	5SD74181	23690.-
5SD74131				
5SD74141				
5SD74121	Type 2	N-PE	5SD74180	15735.-
5SD74131				
5SD74141				
5SD7463-0/1	Type 2	L-N	5SD74681	6180.-
5SD7464-0/1				
5SD7464-0/1				
5SD7422-0/1	Type 2	N-PE	5SD74880	6180.-
5SD7422-0/1				
5SD7422-0/1				
5SD7422-0/1	Type 2	L-N	5SD74281	4770.-
5SD7422-0/1				
5SD7422-0/1				
5SD7422-0/1	Type 2	N-PE	5SD74280	9030.-
5SD7422-0/1				
5SD7422-0/1				
5SD7483-6	PV	-	5SD74983	Price on request

\* Also available Type 1+ Type 2 and Type1/2 Compact SPDs for protection against overvoltages from Lightning strikes as well as by switching operations in network

Note:

Standard packing: 1 unit

\* LP - List Price

Kindly contact at [info@sbsyscon.in](mailto:info@sbsyscon.in) ( S B Syscon Pvt Ltd ) for best prices -  
Authorised Channel Partner for Siemens



# SENTRON Modular Devices

For efficient control and monitoring

- 7LF time switch - Digital and Analog timers for all applications; available in Mini, Top, Profi, Astro, Expert and Expert GPS variants
- 5TT5 insta contactors – For all control applications; also with Manual/Automatic switching indicator
- DIN mounted phase indicators, monitoring relays and measuring devices for final distribution circuits
- Twilight Switch for Automatic Street Light Control

[www.siemens.co.in](http://www.siemens.co.in)

**SIEMENS**

## Modular Devices

	Item Description	Rated Current I <sub>n</sub> (A)	MW#	Reference No	Unit LP* ₹	Std. Pkg.** (Nos.)
<b>Changeover switches</b> Standards: IEC 60947-3/DIN EN 60947-3						
	1C/O, 230V	20	1	5TE8161	2130.-	1/10
	2C/O, 400V	20	1	5TE8162	3885.-	1/10
	Group switch, center position, 2C/O, 400V	20	1	5TE8142	4485.-	1/10
<b>Insta Contactors</b> Standards: EN 60947-4-1, EN 60947-5-1						
	2NO contacts, 230Vac	20	1	5TT58000	3380.-	1/5
	3NO+1NC contacts, 230Vac/220Vdc (1NC contact rated for 30A)	40	3	5TT58410	9250.-	1/5
	3NO+1NC contacts, 24Vac/24Vdc (1NC contact rated for 30A)	40	3	5TT58412	9290.-	1/5
	4NO contacts, 230Vac/220Vdc	40	3	5TT58400	9320.-	1/5
	4NO contacts, 24Vac/24Vdc	40	3	5TT58402	9155.-	1/5
	3NO+1NC contacts, 230Vac/220Vdc (1NC contact rated for 30A)	63	3	5TT58510	12880.-	1/5
	3NO+1NC contacts, 24Vac/24Vdc, (1NC contact rated for 30A)	63	3	5TT58512	13620.-	1/5
	4NO contacts, 230Vac/220Vdc	63	3	5TT58500	11810.-	1/5
4NO contacts, 24Vac/24Vdc	63	3	5TT58502	12450.-	1/5	
<b>Insta Contactors Manual / Automatic with Switching Indicator</b> Standards: IEC60947-4-1, IEC60947-5-1						
	2NO contacts, 230Vac	20	1	5TT58006	4500.-	1/5
	1NO+1NC contacts, 230Vac	20	1	5TT58016	6780.-	1/5
	4NO contacts, 230Vac	25	2	5TT58306	6375.-	1/5
	4NO contacts, 400Vac	40	3	5TT58406	14035.-	1/5
	4NO contacts, 400Vac	63	3	5TT58506	17785.-	1/5
<b>Accessories</b>						
	Control Switch with 1 Make and 1 Break Contact For AC 230V/400V For 5TT58 and 5TT50			5TT59101	3845.-	1/10





Note:

\* LP - List Price # 1MW (Module Width) = 18mm

\*\* Purchase MOQ for our authorised dealers is in multiples of standard packing, contact Siemens Sales Office for further details



## Modular Devices

	Item Description	Rated Current $I_n$ (A)	MW#	Reference No	Unit LP* ₹	Std. Pkg.** (Nos.)
<b>Twilight switch</b>						
	Twilight Switch with light sensor 230 V, 50/60 Hz, 1MW, 16A			7LQ2300	Price on request	1
<b>Voltage Relays</b> Standards: IEC 60255, DIN VDE 0435-303						
	Voltage relay for undervoltage monitoring of 1,2,3 phases against N with phase failure detection, Switching thresholds 0.7-0.9xV, not adjustable; 2 C/O contacts, 4A, 230/400Vac	4	2	5TT3402	14840.-	1
	Voltage relay for undervoltage monitoring of 1,2,3 phases against N, short time failure detection with phase failure detection and N conductor monitoring, Switching thresholds 0.8-0.85xV, not adjustable; 2 C/O contacts, 230/400Vac	4	2	5TT3407	24715.-	1
	Voltage relay for over and undervoltage monitoring of 3 phases against N with asymmetry, reverse voltage and phase failure detection with N conductor monitoring and adj. Time delay of 0.1 to 20s, Switching thresholds: U/voltage 0.7-1.1xV, 4% hysteresis, adjustable, O/voltage 0.9-1.1xV, 4% hysteresis, adjustable; 2 C/O contacts, 230/400Vac	4	2	5TT3408	28450.-	1
<b>RYG 3 phase indicator in 1MW</b>						
	3 phase indicator (all with green color cap)		1	5TE5802	3830.-	1/10
	3 phase indicator (red/yellow/green)		1	5TE5803	3260.-	1/10
	Transparent cap (1 set = 3 items, R, Y, G lens)			5TG8070	1060.-	1/10
<b>Power ON Indicator (Economy Version) 230 Vac, 1 Phase</b>						
	Light indicators for max. cable length up to 5 m with 1 red lamp		1	5TE5800	2025.-	1/12
	Light indicators for max. cable length up to 250 m with 1 red lamp		1	5TE5804	1615.-	1/12
	Transparent cap (Red)			5TG8061	150.-	5
	Transparent cap (Green)			5TG8062	150.-	5
	Transparent cap (Yellow)			5TG8063	150.-	5
	Transparent cap (Blue)			5TG8064	150.-	5
<b>Fuse Monitor</b>						
	Fuse monitors with transparent caps for all low voltage fuse systems, 230Vac	4	2	5TT3170	11640.-	1



Note:

\* LP - List Price # 1MW (Module Width) = 18mm

\*\* Purchase MOQ for our authorised dealers is in multiples of standard packing, contact Siemens Sales Office for further details



## Modular Devices

	Item Description	Rated Current I <sub>n</sub> (A)	MW#	Reference No	Unit LP* ₹	Std. Pkg.** (Nos.)
<b>Time Switches (Digital)</b>						
	Mini digital, daily/weekly program, 100 hours reserve, 230Vac	16	1	7LF45015	8675.-	1
	Yearly time switch top digital 230V, 1 channel	16	2	7LF45110	10370.-	1
	Yearly time switch top digital 230V, 2 channel	16	2	7LF45120	22560.-	1
	Weekly time switch profi digital 230V, 1 channel	16	2	7LF45210	21020.-	1
	Weekly time switch profi digital 230V, 2 channel	16	2	7LF45220	27180.-	1
	Weekly time switch astro digital 230V, 1 channel	16	2	7LF45310	18795.-	1
	Weekly time switch astro digital 230V, 2 channel	16	2	7LF45320	48710.-	1
<b>Time Switches (Mechanical) Standards: EN 60730-1</b>						
 7LF53005	Quartz time switch Day 1 NO 230V/50-60Hz 1 MW with power reserve	16	1	7LF53011	7100.-	1
	Synchronous time switches without power reserve, for DIN rail mounting, day disk, 1CO, 230V AC	16	3	7LF53005	3920.-	1
	Quartz-clock time switches with power reserve for DIN rail mounting, day disk, 1CO, 230V AC	16	3	7LF53016	7575.-	1
	Quartz-clock time switches with power reserve for wall mounting, day disk, 1CO, 250Vac	16	—	7LF53050	11335.-	1
	Synchronous time switches without power reserve, for wall mounting, day disk, 1CO, 250Vac	16	—	7LF53010	6910.-	1
<b>Accessories for Digital Time Switches</b>						
	USB adapter and software			7LF49410	31965.-	1
	Data key profi, astro			7LF49411	3255.-	1

Note:

\* LP - List Price

# 1MW (Module Width) = 18mm

\*\* Purchase MOQ for our authorised dealers is in multiples of standard packing, contact Siemens Sales Office for further details



Kindly contact at [info@sbsyscon.in](mailto:info@sbsyscon.in) ( S B Syscon Pvt Ltd ) for best prices -  
Authorised Channel Partner for Siemens



**SINOVA**

# 3VJ Moulded Case Circuit Breakers

**Simply Efficient**

- Rated current: 20A to 400A
- 1 pole, 2 pole, 3 pole & 4 pole versions
- Breaking capacity: 10kA to 55kA
- Thermal magnetic trip unit (FTFM, ATFM)
- Range of internal and external accessories

[www.siemens.co.in](http://www.siemens.co.in)

**SIEMENS**

### 3VJ Moulded Case Circuit Breakers<sup>\$</sup>

#### 3VJ MCCB, Thermal Magnetic Trip Unit, Fixed Thermal Fixed Magnetic (FTFM), 415VAC, 50Hz

Frame Size	Breaking Capacity @415V AC, 50/60Hz	Rated Current In (A)	3 Pole Type	4 Pole Type
3VJ10 (VJ1 125X)	18kA	20	3VJ1002-1DA32-0AA0	3VJ1002-1EA42-0AA0
		25	3VJ1092-1DA32-0AA0	3VJ1092-1EA42-0AA0
		32	3VJ1003-1DA32-0AA0	3VJ1003-1EA42-0AA0
		40	3VJ1004-1DA32-0AA0	3VJ1004-1EA42-0AA0
		50	3VJ1005-1DA32-0AA0	3VJ1005-1EA42-0AA0
		63	3VJ1006-1DA32-0AA0	3VJ1006-1EA42-0AA0
		80	3VJ1008-1DA32-0AA0	3VJ1008-1EA42-0AA0
		100	3VJ1010-1DA32-0AA0	3VJ1010-1EA42-0AA0
		125	3VJ1012-1DA32-0AA0	3VJ1012-1EA42-0AA0
	25kA	20	3VJ1002-3DA32-0AA0	3VJ1002-3EA42-0AA0
		25	3VJ1092-3DA32-0AA0	3VJ1092-3EA42-0AA0
		32	3VJ1003-3DA32-0AA0	3VJ1003-3EA42-0AA0
		40	3VJ1004-3DA32-0AA0	3VJ1004-3EA42-0AA0
		50	3VJ1005-3DA32-0AA0	3VJ1005-3EA42-0AA0
		63	3VJ1006-3DA32-0AA0	3VJ1006-3EA42-0AA0
		80	3VJ1008-3DA32-0AA0	3VJ1008-3EA42-0AA0
		100	3VJ1010-3DA32-0AA0	3VJ1010-3EA42-0AA0
		125	3VJ1012-3DA32-0AA0	3VJ1012-3EA42-0AA0
3VJ12 (VJ1 250)		160	3VJ1216-3DA32-0AA0	3VJ1216-3EA42-0AA0
		200	3VJ1220-3DA32-0AA0	3VJ1220-3EA42-0AA0
		250	3VJ1225-3DA32-0AA0	3VJ1225-3EA42-0AA0

#### 3VJ MCCB, Thermal Magnetic Trip Unit, Adjustable Thermal Fixed Magnetic (ATFM), 415VAC, 50Hz

Frame Size	Breaking Capacity @415V AC, 50/60Hz	Rated Current In (A)	3 Pole Type	4 Pole Type
3VJ10 (VJ1 125X)	25kA	20	3VJ1002-3DB32-0AA0	3VJ1002-3EB42-0AA0
		25	3VJ1092-3DB32-0AA0	3VJ1092-3EB42-0AA0
		32	3VJ1003-3DB32-0AA0	3VJ1003-3EB42-0AA0
		40	3VJ1004-3DB32-0AA0	3VJ1004-3EB42-0AA0
		50	3VJ1005-3DB32-0AA0	3VJ1005-3EB42-0AA0
		63	3VJ1006-3DB32-0AA0	3VJ1006-3EB42-0AA0
		80	3VJ1008-3DB32-0AA0	3VJ1008-3EB42-0AA0
		100	3VJ1010-3DB32-0AA0	3VJ1010-3EB42-0AA0
		125	3VJ1012-3DB32-0AA0	3VJ1012-3EB42-0AA0
3VJ12 (VJ1 250)		160	3VJ1216-3DB32-0AA0	3VJ1216-3EB42-0AA0
		200	3VJ1220-3DB32-0AA0	3VJ1220-3EB42-0AA0
		250	3VJ1225-3DB32-0AA0	3VJ1225-3EB42-0AA0
3VJ13 (VJ1 400)		320	3VJ1332-3DB32-0AA0	3VJ1332-3EB42-0AA0
		400	3VJ1340-3DB32-0AA0	3VJ1340-3EB42-0AA0
3VJ11 (VJ1 125)	36kA	25	3VJ1192-5DB32-0AA0	3VJ1192-5EB42-0AA0
		32	3VJ1103-5DB32-0AA0	3VJ1103-5EB42-0AA0
		40	3VJ1104-5DB32-0AA0	3VJ1104-5EB42-0AA0
		50	3VJ1105-5DB32-0AA0	3VJ1105-5EB42-0AA0
		63	3VJ1106-5DB32-0AA0	3VJ1106-5EB42-0AA0
		80	3VJ1108-5DB32-0AA0	3VJ1108-5EB42-0AA0
		100	3VJ1110-5DB32-0AA0	3VJ1110-5EB42-0AA0
3VJ12 (VJ1 250)		125	3VJ1112-5DB32-0AA0	3VJ1112-5EB42-0AA0
		160	3VJ1216-5DB32-0AA0	3VJ1216-5EB42-0AA0
		200	3VJ1220-5DB32-0AA0	3VJ1220-5EB42-0AA0
3VJ13 (VJ1 400)		250	3VJ1225-5DB32-0AA0	3VJ1225-5EB42-0AA0
		320	3VJ1332-5DB32-0AA0	3VJ1332-5EB42-0AA0
3VJ13 (VJ1 400)		400	3VJ1340-5DB32-0AA0	3VJ1340-5EB42-0AA0

<sup>\$</sup> Kindly refer latest Power Distribution Products Price List for prices

3VJ Internal accessories<sup>5</sup>

Frame Size	Accessory compartment/ Coil voltage	3VJ10 (VJ1 125X)	3VJ11 (VJ1 125)	3VJ12 (VJ1 250)	3VJ13 (VJ1 400)
Auxiliary Switches (AUX)	Left	3VJ9018-0AN11	3VJ9218-0AN11	3VJ9218-0AN11	3VJ9417-0AN11
	Right	-	3VJ9218-0AN21	3VJ9218-0AN21	3VJ9417-0AN21
Auxiliary + Alarm Switches (AUX+AL)	Left	3VJ9018-0AD11	3VJ9118-0AD11	3VJ9218-0AD11	3VJ9417-0AD11
	Right	-	3VJ9118-0AD21	3VJ9218-0AD21	3VJ9417-0AD21

3VJ External accessories<sup>5</sup>

Frame Size	Accessory	3VJ10 (VJ1 125X)	3VJ11 (VJ1 125)	3VJ12 (VJ1 250)	3VJ13 (VJ1 400)
	Extended Door Mounted Rotary Operator (including 8UC handle)	3VJ9018-0HD11	3VJ9118-0HD11	3VJ9218-0HD11	3VJ9417-0HD11

Raja+ DOL Starters<sup>@</sup>  
 3TW Direct On Line Starters



3ph, 50Hz DOL Starter in sheet steel housing, including bimetal relay with single phasing protection

	Motor Rating At 415V 3ph 50Hz		Starter Type	Contactors	Thermal Overload Relay	Relay range (A)	Max. Full Load Current (Amp)		Std. Pkg. (Nos.)
	HP	kW					3Ph, 415V 4P Squirrel Cage IS 8789:1996 Table 4	3Ph, 415V 2P MRP Submersible motor IS 9283:1995 Table 2	
	0.33	0.25	3TW7291-1A^64	3TS3010-0A##-08KA0	3UW5102-0J	0.63-1	-	-	1
	0.75	0.55	3TW7291-1A^66	3TS3010-0A##-08KA0	3UW5102-1A	1-1.6	1.7	-	1
	1	0.75	3TW7291-1A^68	3TS3010-0A##-08KA0	3UW5102-1C	1.6-2.5	2.2	-	1
	1.5	1.1	3TW7291-1A^69	3TS3010-0A##-08KA0	3UW5102-1D	2-3.2	2.9	3.25	1
	2	1.5	3TW7291-1A^71	3TS3010-0A##-08KA0	3UW5102-1F	3.2-5	3.8	4.5	1
	3	2.2	3TW7291-1A^72	3TS3010-0A##-08KA0	3UW5102-1G	4-6.3	5.1	6.5	1
	5	3.7	3TW7291-1A^74	3TS3010-0A##-08KA0	3UW5102-1J	6.3-10	8.1	10	1
	7.5	5.5	3TW7291-1A^75	3TS3210-0A##-08KA0	3UW5102-1K	8-12.5	11.4	14.5	1
	7.5	5.5	3TW7291-1A^77	3TS3210-0A##-08KA0	3UW5102-2A	10-16	-	-	1
	10	7.5	3TW7291-1A^78	3TS3210-0A##-08KA0	3UW5102-2B	12.5-20	15.4	19.5	1

^ Enter code for coil voltage, 50Hz (B for 200-400V AC, W for 332 - 456V AC)

## Enter Code for operating coil voltage, 50 Hz (Z6 for 200-400V, R0 for 415V)

\* MRP - Maximum Retail Price LP - List Price

\$ Kindly refer latest Power Distribution Products Price List for prices

@ Kindly refer latest Control Products Price List for prices

## Switch disconnecter fuse@ Superswitch 3KL8 in open execution 3PN

### Switch Disconnector fuse: 3KL8 for power distribution (in Open Execution 3PN)^

	Rated current Ie @ 690V AC 50Hz	SDF suitable for DIN type HRC Fuses	SDF suitable for BS type HRC Fuses	SDF suitable for cylindrical type HRC Fuses	Std. pkg. (nos.)
	20A	3KL8111-5TA00	3KL8111-5TJ00	3KL8111-5TC00	1
	32A	3KL8121-5TA00	3KL8121-5TJ00	3KL8121-5TC00	1
	63A	3KL8151-5TA00	3KL8151-5TJ00	3KL8151-5TC00	1
	100A	3KL8171-5TA00	-	-	1
	100A	3KL8211-5TA00	3KL8211-5TJ00	-	1
	125A	3KL8221-5TA00	3KL8221-5TJ00	-	1
	160A	3KL8231-5TA00	3KL8231-5TJ00	-	1
	200A	3KL8311-5UA00	3KL8311-5UJ00	-	1
	250A	3KL8321-5UA00	3KL8321-5UJ00	-	1
	315A	3KL8331-5UA00	3KL8331-5UJ00	-	1
	400A	3KL8341-5UA00	3KL8341-5UJ00	-	1
	500A	3KL8411-5UA00	3KL8411-5UJ00	-	1
	630A	3KL8421-5UA00	3KL8421-5UJ00	-	1
	800A	3KL8431-5UA00	3KL8431-5UJ00	-	1

^ 3PN is 3 Pole with neutral link

### Selection table for SS Housing for 3KL8



	Rated current Ie (A)	Reference No	Unit MRP* ₹	Std. Pkg. (Nos.)
	3KL81 (20A - 63A)	3KX8235-4AC	-	1
	3KL82 (100A - 160A)	3KX8235-4AC	-	1
	3KL83 (200A - 400A)	3KX8345-4AC	-	1
	3KL84 (500A - 800A)	3KX8435-4AC	-	1

Rated current Ie (A)	Gland box Reference No.	Unit MRP* ₹	Gland Plate Reference No.	Unit MRP* ₹	Std Pkg. (Nos.)
3KL81(20A-63A)	3KX8235-4DC	-	3KX8235-4GC	-	1
3KL82(100A-160A)	3KX8235-4DC	-	3KX8235-4GC	-	1
3KL83(200A-400A)	3KX8345-4DC	-	3KX8345-4GC	-	1
3KL84(500A-800A)	3KX8435-4DC	-	3KX8435-4GC	-	1



## LV HRC Fuses@

### DIN Type Fuse

Rated voltage: 500 V AC

	Size	Rated current A	Reference No	Unit MRP* ₹	Std. Pkg. (Nos.)
	000	2	3NA7 802-ORC	-	1/6
		4	3NA7 804-ORC	-	
		6	3NA7 801-ORC	-	
		10	3NA7 803-ORC	-	
		16	3NA7 805-ORC	-	
		20	3NA7 807-ORC	-	
		25	3NA7 810-ORC	-	
		32	3NA7 812-ORC	-	
		40	3NA7 817-ORC	-	
		50	3NA7 820-ORC	-	
		63	3NA7 822-ORC	-	
		80	3NA7 824-ORC	-	
		100	3NA7 830-ORC	-	
	00	125	3NA7 832-ORC	-	
		160	3NA7 836-ORC	-	
	1	50	3NA7 120-ORC	-	1/3
		63	3NA7 122-ORC	-	
		80	3NA7 124-ORC	-	
		100	3NA7 130-ORC	-	
		125	3NA7 132-ORC	-	
		160	3NA7 136-ORC	-	
		200	3NA7 140-ORC	-	
		224	3NA7 142-ORC	-	
		250	3NA7 144-ORC	-	

# 400 & 800A fuses - Rated voltage at 415 V AC

	Size	Rated current A	Reference No	Unit MRP* ₹	Std. Pkg. (Nos.)
	2	200	3NA7 240-ORC	-	1/3
		250	3NA7 244-ORC	-	
		315	3NA7 252-ORC	-	
		400#	3NA7 260-ORC	-	
	3	315	3NA3 352-ORC	-	1/3
		400	3NA3 360-ORC	-	
		500	3NA3 365-ORC	-	
		630	3NA3 372-ORC	-	
		800#	3NA3 375-4RC	-	

### BS Fuses

	Type	Rated current A	Reference No	Unit MRP* ₹	Std. Pkg. (Nos.)
	Offset Tag	2	3NW TIA2	-	20
		4	3NW TIA4	-	
		6	3NW TIA6	-	
		10	3NW TIA10	-	
		16	3NW TIA16	-	
		20	3NW TIA20	-	
		25	3NW TIA25	-	
		32	3NW TIA32	-	
		40	3NW TIS40	-	
		50	3NW TIS50	-	
		63	3NW TIS63	-	

Note: \* MRP - Maximum Retail Price

@ Kindly refer latest Power Distribution Products Price List for prices

## Betagard Distribution Boards 8GB0 SPN and TPN DBs

	Item Description	Incoming Slots (MW)	Outgoing Slots (MW)	Total Slots (MW)	Reference No	Unit MRP* ₹	Std. Pkg.** (Nos.)
<b>Plastic Enclosure, IP20:</b>							
	3/4 Way	-	-	4	8GB0004	Price on request	1/50
	6 Way	-	-	6	8GB0006		1/25
<b>Double Door SPN DBs, IP42 :</b>							
	4 Way	2	4	6	8GB0204RC	Price on request	1
	6 Way	2	6	8	8GB0206RC		1
	8 Way	2	8	10	8GB0208RC		1
	12 Way	2	12	14	8GB0212RC		1
	14 Way	2	14	16	8GB0214RC		1
<b>Double Door TPN DBs (Horizontal), IP42 :</b>							
	4 Way	8	12	20	8GB0404HRC	Price on request	1
	6 Way	8	18	26	8GB0406HRC		1
	8 Way	8	24	32	8GB0408HRC		1
	12 Way	8	36	44	8GB0412HRC		1
<b>Double Door TPN DBs (Vertical), IP42 :</b>							
	4 Way	8	12	20	8GB0404VRC	Price on request	1
	6 Way	8	18	26	8GB0406VRC		1
	8 Way	8	24	32	8GB0408VRC		1
	12 Way	8	36	44	8GB0412VRC		1
<b>Double Door, Per Phase Isolation TPN DBs (Horizontal), IP42 :</b>							
	4 Way	8	18	26	8GB0405HRC	Price on request	1
	6 Way	8	24	32	8GB0407HRC		1
	8 Way	8	30	38	8GB0409HRC		1
	12 Way	8	42	50	8GB0413HRC		1
<b>Double Door, Per Phase Isolation TPN DBs (Vertical), IP42 :</b>							
	4 Way	8	18	26	8GB0405VRC	Price on request	1
	6 Way	8	24	32	8GB0407VRC		1
	8 Way	8	30	38	8GB0409VRC		1
	12 Way	8	42	50	8GB0413VRC		1
<b>Double Door, Phase Segregated TPN DBs (7 segment), IP42:</b>							
	4 Way	12	12+12	36	8GB0504	Price on request	1
	6 Way	12	12+18	42	8GB0506		1
	8 Way	12	12+24	48	8GB0508		1
	12 Way	12	12+36	60	8GB0512		1

Note: \* MRP - Maximum Retail Price

\*\* Purchase MOQ for our authorized dealers is in multiples of standard packing, contact Siemens Sales Office for further details

Available till stocks last

## Betagard Distribution Boards 8GB31

	Item Description	Incoming Slots (MW)	Outgoing Slots (MW)	Total Slots (MW)	Reference No	Unit MRP* ₹	Std. Pkg.** (Nos.)
<b>Betaflex (Flexi DBs), IP42 :</b>							
	2Row x 12Mod	—	—	24	8GB31424RC	Price on request	1
	2Row x 16Mod	—	—	32	8GB31426RC		1
	4Row x 6Mod	—	—	24	8GB31441RC		1
	4Row x 8Mod	—	—	32	8GB31442RC		1
	4Row x 10Mod	—	—	40	8GB31443RC		1
	4Row x 12Mod	—	—	48	8GB31444RC		1
	4Row x 16Mod	—	—	64	8GB31446RC		1
<b>Betabus (Vertical Busbar DBs with MCB as an incomer), IP42 : (Suitable for 5SL/5SP MCBs, upto 125A as an incomer)</b>							
	4 way	12	12	24	8GB31471RC	Price on request	1
	6 way	12	18	30	8GB31473RC		1
	8 way	12	24	36	8GB31474RC		1
	12 way	12	36	48	8GB31477RC		1
<b>Betabusplus (Vertical Busbar DBs with MCCB as an incomer), IP42 : (Suitable for 3VT1/3VA1 MCCBs, upto 160A as an incomer)</b>							
	4 way	12	12	24	8GB31571RC	Price on request	1
	6 way	12	18	30	8GB31572RC		1
	8 way	12	24	36	8GB31573RC		1
	12 way	12	36	48	8GB31574RC		1
<b>BetaMulti (DBs for power &amp; communication), IP42 :</b>							
	12 way SPN, provision	2	12	14	8GB31215RC	Price on request	1
	4 Way TPN, Provision	8	12	20	8GB31220RC		1
	6 way TPN, provision	8	18	26	8GB31221RC		1
	8 Way TPN Provision	8	24	32	8GB31222RC		1





Available till stocks last

Note:

\* MRP - Maximum Retail Price

\*\* Purchase MOQ for our authorised dealers is in multiples of standard packing, contact Siemens Sales Office for further details

## Betagard Distribution Boards 8GB31

	Item Description	Incoming Slots (MW)	Outgoing Slots (MW)	Total Slots (MW)	Reference No	Unit MRP* ₹	Std. Pkg.** (Nos.)
<b>Beta CO (DBs with built-in pre-wired phase changeover switches), IP42 :</b>							
	40 A, 4 Way TPN, built-in	8	12	20	8GB31850RC	Price on request	1
	40 A, 6 Way TPN, built-in	8	18	26	8GB31851RC		1
	40 A, 8 Way TPN, built-in	8	24	32	8GB31852RC		1
	40 A, 12 Way TPN, built-in	8	36	44	8GB31854RC		1
	63 A, 4 Way TPN, built-in	8	12	20	8GB31860RC		1
	63 A, 6 Way TPN, built-in	8	18	26	8GB31861RC		1
	63 A, 8 Way TPN, built-in	8	24	32	8GB31862RC		1
	63 A, 12 Way TPN, built-in	8	36	44	8GB31864RC		1
<b>Wire Way Boxes (WWB)</b>							
	WWB for Flexi DB,8Mod	—	—	—	8GB9908FWWNT	Price on request	1/5
	WWB for Flexi DB,12Mod	—	—	—	8GB9912FWWNT		1/5
	WWB for Flexi DB,16Mod	—	—	—	8GB9916FWWNT		1/5
	WWB for Bus DB	—	—	—	8GB99BUSWWNT		1/5
	WWB for Bus Plus DB	—	—	—	8GB99PLUSWWNT		1/5
<b>Modular Device Boxes (MDB)</b>							
	MDB for Flexi DB, 8Mod/Row	—	—	8	8GB9908FMDTC	Price on request	1/5
	MDB for Flexi DB,12Mod/Row	—	—	12	8GB9912FMDTC		1/5
	MDB for Flexi DB,16Mod/Row	—	—	16	8GB9916FMDTC		1/5
	MDB for Bus DB	—	—	12	8GB99BUSMBTC		1/5
	MDB for Bus Plus DB	—	—	12	8GB99PLUSMBTC		1/5
<b>BetaMulti (DBs for power &amp; communication), IP42 :</b>							
	12 way SPN, built-in	2	12	14	8GB31315RC	Price on request	1
	4 Way TPN, Built-in	8	12	20	8GB31320RC		1
	6 way TPN, built-in	8	18	26	8GB31321RC		1
	8 Way TPN, Built-in	8	24	32	8GB31322RC		1
<b>Beta CO (DBs with provision for phase changeover switches), IP42 :</b>							
	4 way, with provision	8	12	20	8GB31840RC	Price on request	1
	6 way, with provision	8	18	26	8GB31841RC		1
	8 way, with provision	8	24	32	8GB31842RC		1
	12 way, with provision	8	36	44	8GB31844RC		1

Note:

\* MRP - Maximum Retail Price

\*\* Purchase MOQ for our authorised dealers is in multiples of standard packing, contact Siemens Sales Office for further details



## Betagard Circuit Breakers 5SY7, with D Characteristics

Reference No.	Reference No.	Reference No.	Reference No.
5SY71058CC	5SY72058CC	5SY73058CC	5SY74058CC
5SY71018CC	5SY72018CC	5SY73018CC	5SY74018CC
5SY71028CC	5SY72028CC	5SY73028CC	5SY74028CC
5SY71038CC	5SY72038CC	5SY73038CC	5SY74038CC
5SY71048CC	5SY72048CC	5SY73048CC	5SY74048CC
5SY71068CC	5SY72068CC	5SY73068CC	5SY74068CC
5SY71088CC	5SY72088CC	5SY73088CC	5SY74088CC
5SY71108CC	5SY72108CC	5SY73108CC	5SY74108CC
5SY71138CC	5SY72138CC	5SY73138CC	5SY74138CC
5SY71168CC	5SY72168CC	5SY73168CC	5SY74168CC
5SY71208CC	5SY72208CC	5SY73208CC	5SY74208CC
5SY71258CC	5SY72258CC	5SY73258CC	5SY74258CC
5SY71328CC	5SY72328CC	5SY73328CC	5SY74328CC
5SY71408CC	5SY72408CC	5SY73408CC	5SY74408CC
5SY71508CC	5SY72508CC	5SY73508CC	5SY74508CC
5SY71638CC	5SY72638CC	5SY73638CC	5SY74638CC

## Betagard Circuit Breakers 5SY5, DC with C Characteristics

Reference No.	Reference No.
5SY51057CC	5SY52057CC
5SY51017CC	5SY52017CC
5SY51027CC	5SY52027CC
5SY51037CC	5SY52037CC
5SY51047CC	5SY52047CC
5SY51067CC	5SY52067CC
5SY51087CC	5SY52087CC
5SY51107CC	5SY52107CC
5SY51137CC	5SY52137CC
5SY51167CC	5SY52167CC
5SY51207CC	5SY52207CC
5SY51257CC	5SY52257CC
5SY51327CC	5SY52327CC
5SY51407CC	5SY52407CC
5SY51507CC	5SY52507CC
5SY51637CC	5SY52637CC

## Betagard Distribution Boards MB DBs

Reference No.	Reference No.
8GB31810RC01	8GB31810RC03
8GB31811RC01	8GB31811RC03
8GB31812RC01	8GB31812RC03
8GB31813RC01	8GB31813RC03
8GB31814RC01	8GB31814RC03
8GB31815RC01	8GB31815RC03
8GB31810RC02	
8GB31811RC02	
8GB31812RC02	
8GB31813RC02	
8GB31814RC02	
8GB31815RC02	

Discontinued Products

## Terms and Conditions

Maximum Retail Price (MRP) / List Price (LP) is subject to revision without prior notice.

The company reserves the right to supply goods at its works or godown at its discretion.

The minimum order size for non-stock items (items not marked with ■) is 50 Nos. for each item or ₹ 50,000/- per item.

**Export control regulation - retention clause:** The fulfillment of the agreement on Siemens part is subject to the provision that this shall not be prevented by implements on the grounds of national and international legal requirements, in particular export control provision.

### Stock items

The normal stock items (indicated by ■) are subject to change without prior notice.

### Note

- This supercedes all previous Price Lists.
- List Prices (LPs) mentioned are exclusive of all taxes.
- Maximum Retail Prices (MRPs) mentioned in the publication are maximum recommended selling prices.
- Invoice amount not to exceed MRP
- Invoice amount = MRP (less) applicable discount + applicable GST %
- For receiving material in factory sealed packing, we request you to order in multiples of the indicated standard packing quantity.

Ask your nearest Siemens partners to include you in our mailing list.

Always make your purchases only from our authorised dealers. Details available with our sales office/territory managers.

Kindly contact at [info@sbsyscon.in](mailto:info@sbsyscon.in) ( S B Syscon Pvt Ltd ) for best prices -  
Authorised Channel Partner for Siemens



# SENTRON 7KN Powercenter 1000

[www.siemens.co.in](http://www.siemens.co.in)

**SIEMENS**



### Monitoring and Protection

Detection of switching status and differentiation of tripping due to faults



### Signals and Warning

Alarm signals when exceeding a limit value



### Predictive Maintenance

Integrated operating cycles counter, operating hours and trip counter



### Data Acquisition

Measurement of current, voltages, mains frequency and temperature



### Overview of Energy Consumption

Measurement of Power and Energy values



### Communication Interface

through integrated MODBUS TCP and wireless interface

SENTRON circuit protection devices

Measurement

COM

Kindly contact at [info@sbsyscon.in](mailto:info@sbsyscon.in) ( S B Syscon Pvt Ltd ) for best prices -  
Authorised Channel Partner for Siemens



## 7KT PAC1200

Multichannel current measuring system for flexible multichannel monitoring in final distribution

### Current Sensors

- Versions: 40 A, 63 A

### Sensor Bar

- Versions available for 3, 6, 9, 12

### Data Manager

- Connection of up to 96 sensors (40A/63A)
- DIN rail installation (4MW)

### Communication/ Software:

- Modbus TCP/ IP
- Simple system onfiguration via web server
- Easy access to energy data with mobile app (iOS/Android)

\*For more details, contact nearest Siemens Sales Office

[www.siemens.com/powermonitoring](http://www.siemens.com/powermonitoring)

**SIEMENS**



Easy



Transparent



Cost-efficient



## Relevant Standards

Title	IS	IEC	Products							
			MCB		RCCB		RCBO	DB	AFDD	SPD
			5SL4/6/7	5SL5	5SV	5SM	5SU1	8GB	5SM6	5SD7
Electric Installations – MCBs for Building Installations and Similar Purposes Part 1: MCBs for AC Systems	IS 60898-1	IEC 60898-1	✓	–	–	–	–	–	–	–
Low-voltage switchgear and controlgear Part 2: Circuit-breakers	IS 60947-2	IEC 60947-2	–	✓	–	–	–	–	–	–
Residual Current Operated Circuit-Breakers for Household and Similar Uses, Part 1: Circuit-Breakers Without Integral Overcurrent Protection (RCCBs)	IS 12640-1	IEC 61008-1	–	–	✓	✓	–	–	–	–
Residual Current Operated Circuit-Breaking for Household and Similar Uses, Part 2: Circuit-Breakers with Integral Overcurrent Protection (RCBOs)	IS 12640-2	IEC 61009-1	–	–	–	–	✓	–	–	–
General requirements for arc fault detection devices	–	IEC 62606	–	–	–	–	–	✓	–	–
Low-voltage switchgear and controlgear assemblies, Part 2: Power switchgear and controlgear assemblies	–	IEC 61439-1/3	–	–	–	–	–	✓	–	–
Surge protective devices connected to low-voltage power systems	–	IEC 61643-11	–	–	–	–	–	–	–	✓



## Degree of Protection

First digit: Protection against solid foreign objects		Second digit: Protection against ingress of water	
	0 No protection		0 No protection
	1 Protected against solid objects up to 50mm (e.g. hand)		1 Protection against vertically falling drops of water (e.g. condensation)
	2 Protected against solid objects up to 12mm diameter (e.g. finger)		2 Protection against direct sprays of water up to 15 degrees from vertical
	3 Protected against solid objects up to 2.5mm diameter (e.g. screwdriver)		3 Protection against direct sprays of water up to 60 degrees from vertical
	4 Protected against solid objects up to 1mm diameter (e.g. wire)		4 Protection against water sprayed from all directions, limited ingress permitted
	5 Protected against dust: limited ingress permitted, no harmful deposit.		5 Protected against low-pressure jets of water from all directions, limited ingress permitted
	6 Totally protected against dust		6 Protected against strong jets of water from all directions, limited ingress permitted (e.g. water from heavy seas on a ship's deck)
			7 Protected against the effect of temporary immersion (30 min) between 15cm and 1m
			8 Protected against long period of immersion under pressure
			9 Protected against high pressure, high temperature jets of water from multiple directions

Technical information



## Installation Guideline for RCCB

### RCCB suitability for various distribution networks.

Betagard RCCBs can be used in all 3 distribution network types viz. TN, TT & an IT network system. 4 pole RCCBs can also be used in 3 pole supply networks by adhering to installation guidelines. In this case, connection must be at terminals 1, 3 and 5 and 2, 4 and 6.

The function of the test equipment is only ensured if a jumper is fitted between terminals 3 and N.

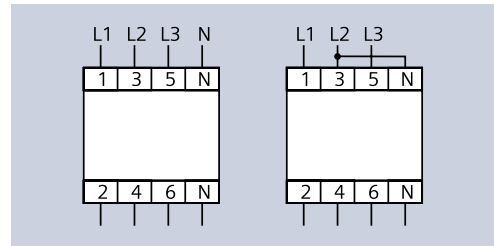

### Types and waveform

					6 mA	10 mA		
Type AC		■	-	-	-	-	-	-
Type A		■	■	■	■	-	-	-
Type F		■	■	■	■	■	■	-
Type B		■	■	■	■	■	■	■
Type B+		■	■	■	■	■	■	■

### Version

SIGRES	with active condensation protection for use in severe ambient conditions
[G] / [K]	super-resistant, 10 ms short-term delayed devices with increased immunity to false triggering due to transient disruptions
[S]	as an upstream group switch for selective shutdown against downstream RCCBs



## Installation locations for Surge Protection Devices (SPDs)

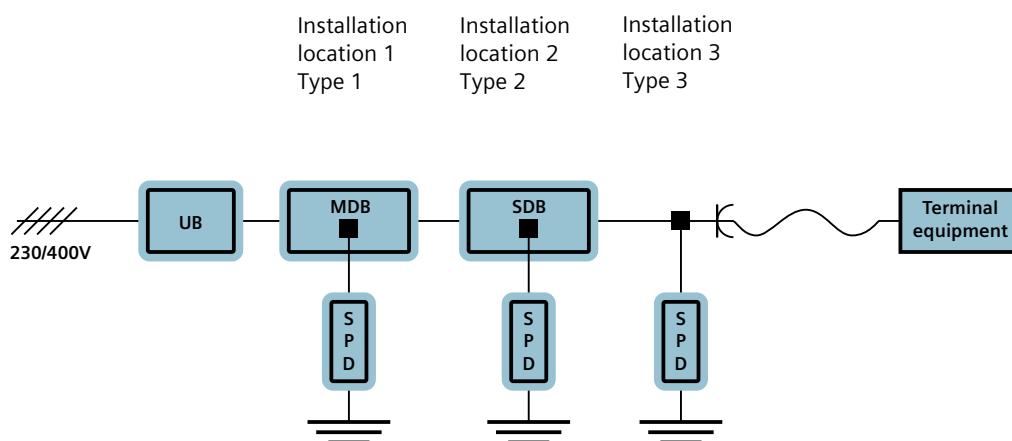

UB: Utility Box

MDB: Main distribution board

SDB: Sub Distribution board

Installation location 1 must be as close as possible to the supply point for the electrical system, so that the downstream installations are protected. The SPDs at installation locations 2 and 3 shall not be used without SPDs at installation location 1, and they must be coordinated with these SPDs (i.e. SPDs all from the same manufacturer).

Kindly contact at [info@sbsyscon.in](mailto:info@sbsyscon.in) ( S B Syscon Pvt Ltd ) for best prices -  
Authorised Channel Partner for Siemens  
One point contact for your service needs

The comprehensive range of services from Siemens is sure to cover the needs of the most varied users. We offer structured

services, designed to give you valuable support in every phase during the lifecycle of your Final Distribution Products.



*Please contact us for more details*

## CUSTOMER CARE

Toll Free No: 1800220987 / 18002090987 • E-mail: [ics.india@siemens.com](mailto:ics.india@siemens.com)

### Customer care

One stop support for all service needs:

- Breakdown service
- Annual maintenance contracts
- Retrofit solutions
- Spares

**For more details please contact:**

Customer care desk

**Siemens Limited**

R&D Technology Centre

Kalwa Works, Thane Belapur Road, Thane - 400 601

Toll free No.: 1800 209 0987 (MTNL/BSNL/Major Mobile operator lines), 1800 220 987 (BSNL/MTNL)

Tel.: 022-27600150 • Fax: 022-33265381

<http://support.automation.siemens.com/in>









# Kindly contact at info@sbsyscon.in ( S B Syscon Pvt Ltd ) for best prices - Authorised Channel Partner for Siemens Your partners

## Sales offices:

**Ahmedabad**  
3rd Floor, Prerna Arbour  
Chimanlal Giridharlal Road, Navarangpura  
Near Girish Colddrinks  
Ahmedabad, Gujarat - 380009

**Baroda**  
Ground Floor, Urja Bhavan  
Maneja Works, Opp. Makarpura Railway Station  
Vadodra - 390010

**Bengaluru**  
1st Floor, Jyoti Mahal, No. 49, St. Marks Rd.  
Bengaluru - 560 001  
☎ : +91 80 33422000  
Fax: +91 80 33424131

**Bhubaneswar**  
Mobile: +91 7894436373  
E-mail: somnath.manna@siemens.com

**Chandigarh**  
Mobile: +91 9888484066  
E-mail: padam.sharma@siemens.com

**Chennai**  
4th Floor, ETA Mount Central  
Seethakathi Business Centre, Mount Road  
Chennai - 600006  
☎ : +91 44 30474000  
Fax: +91 44 30474080

**Coimbatore**  
Mobile: +91 9849001842  
E-mail: pramod.krishna@siemens.com

**Gurgaon**  
Plot No. 78, Tower - B  
Jagatjit Industries Building (JIL)  
Opposite SBI Academy, Sector-18  
Gurgaon - 122015  
☎ : +91 124 2842000, 3810200

**Hyderabad**  
5-9-19, Lakshmi Narasinh Estate  
Hyderabad - 500004  
☎ : +91 40 23482578

**Jaipur**  
Mobile: +91 9815502480  
E-mail: rohit.jagga@siemens.com

**Jamshedpur**  
Mobile: +91 8294052647  
E-mail: shyamal.bhattacharyya@siemens.com

**Kolkata**  
3rd Floor, 43, Shanti Palli, Rashbihari Bypass Connector  
Kolkata - 700042, India  
☎ : +91 33 30939000  
Fax: +91 33 30939010

**Lucknow**  
Mobile: +91 9918002525  
E-mail: atul.shukla@siemens.com

**Mumbai**  
Business Centre-1, Kalwa Works  
Thane Belapur Road  
Thane - 400 601  
☎ : +91 22 39663000  
Fax: +91 22 39663721

**Nagpur**  
Mobile: +91 9930182128  
E-mail: muzaffer.sayed@siemens.com

**Pune**  
Tower C, Panchshil Business Park  
Survey No. 20, Balewadi  
Pune - 411045  
☎ : +91 20 30466000  
Fax: +91 20 30466060

**Vizag**  
Mobile: +91 9701354777  
E-mail: vijaykiran.meduri@siemens.com

## Territory managers:

**Agra**  
Flat No 303, Dwarka Apartment  
Near Hanuman Mandir Crossing  
Bhagirathi Road, Khandari  
Agra - 282002  
Mobile: +91 7800960310  
E-mail: tiwari.mayank@siemens.com

**Aurangabad**  
Shalindra Kumar Maurya  
Mobile: +91 9033563923  
E-mail: shalindra-kumar.maurya@siemens.com

**Belgaum**  
Anuragh Bungalow No. 2, Plot No. 7  
CTS No. 3109, RS No. 57/2/1, Cross No. 7  
Near Shanbag / Bhandari School  
Bhagya Nagar, Angol  
Belgavi, Karnataka - 590006  
Mobile: +91 9740277991  
Tel.: +91 0831 2495156  
E-mail: anand.gawade@siemens.com

**Belgaum**  
3rd Floor, Anand Nivas, B wing  
6th Cross, Bhagyanager, Near Police Booth  
Belgavi, Karnataka - 590006  
Mobile: +91 8105592066  
E-mail: siddu.mareguddi@siemens.com

**Bharuch**  
Mobile: +91 8884000998  
E-mail: vital.kachhadia@siemens.com

**Bhilai**  
Flat No. 408, 5th Floor, Harihar Nagar  
Besa, Nagpur - 440037  
Mobile: +91 7869922211  
E-mail: pravin.deshbhatar@siemens.com

**Bhopal**  
A-88 Shahpura, Bhopal, MP - 462016  
Mobile: +91 9823011883  
E-mail: vineet.saxena@siemens.com

**Boisar**  
Flat 110, Building M4, Tata Shubh Grih  
Maan, Opp. D Mart, Boisar - 401506  
Mobile: +91 9819231892  
E-mail: debashis.biswas@siemens.com

**Cochin**  
53, 1567, Kachappilly Rd, Near Welcare Hospital  
Ponnurruni, Vyttila, Kochi, Kerala - 682019  
Mobile: +91 8606117755  
E-mail: shyam.j@siemes.com

**Durgapur**  
Quarter No. C7, Kunustoria Area Complex  
Near Pragati Stadium  
Raniganj - 713362, West Bengal  
Mobile: +91 9830317456  
E-mail: harsh.chincholkar@siemens.com

**Gandhidham**  
Plot No. 453, DC-5, Adipur  
Gandhidham - 370205  
Mobile: +91 9725005162  
E-mail: maulikumar.patel@siemens.com

**Gorakhpur**  
H.No. 721/T, Sri Ram Nagar Colony  
Near Aluminum Factory  
Beside HK Memorial School, Basaratpur  
Gorakhpur - 273004  
Mobile: +91 8802011478  
E-mail: singh.amar@siemens.com

**Guwahati Assam**  
Shivalaya Housing Society, Flat No. B-3A  
Bylane-4, Joymatinagar, Adabari, Pandu  
Guwahati - 781012, Assam  
Mobile: +91 9864110684  
E-mail: biplab.datta@siemens.com

**Haridwar**  
Mobile: +91 9889384222  
E-mail: umesh.pandey@siemens.com

**Hosur**  
Mobile: +91 +91 9000451122  
E-mail: chandrashekar.r@siemens.com

**Hubli**  
Flat No. 303, Shriya Solitaire  
Opp. Murudeshwar Ceramic Factory  
RN Shetty Road, Hubli, Karnataka - 580024  
Mobile: +91 9945961052  
E-mail: kiran.kage@siemens.com

**Indore**  
Flat No. 103, Block B  
Moti Mahal Apartments, Gumasta Nagar  
Scheme No. 71, Indore - 452009 (M. P.)  
Mobile: +91 9029207888  
E-mail: gaurishankar.rai@siemens.com

**Indore**  
78, Anand Nagar, Chitwad Road  
Indore - 452001 (MP)  
Mobile: +91 9673333024  
E-mail: brajesh.rathor@siemens.com

**Jalandhar**  
H.No. 212A, Punjabi Bahg Extension  
66 Feet Road Near Curo Mall  
Jalandhar, Punjab - 144022  
Mobile: +91 9876047929  
E-mail: sunil.singla@siemens.com

**Jammu**  
Plot No. 592/3, 2nd Floor  
Bhawani Vihar Extension, Trikuta Nagar  
Jammu - 180020  
Mobile: +91 9873084776  
E-mail: sharma.nikhil@siemens.com

**Kanpur**  
110-B, Gandhi Gram, Harijnder Nagar  
Kanpur - 208007, Uttar Pradesh  
Mobile: +91 9650235222  
E-mail: manish.sahu@siemens.com

**Kharagpur**  
Plot No. 3031, 2nd Floor  
Mouza: Basudevpur, PO: Khajanchak  
Manjushree More, District: Purbia Medinipur  
Pin: 721602  
Mobile: +91 9051384193  
E-mail: mitra.sayantan@siemens.com

**Khopoli**  
Flat No. 2, B Wing, Ground Floor  
Bonzer Celebration CHSL  
Survey No. 6, Takai, Tal. Khalapur  
Dist Raigad - 410203  
Mobile: +91 9867021215  
E-mail: akif.qadeer@siemens.com

**Kolhapur**  
RS No. 84-1, Pinac Prasad, Fl No. A-35  
New Palace Road, Kolhapur - 416006  
Mobile: +91 9850836839  
E-mail: vinay.todkar@siemens.com

**Kota**  
A. 1, 1st Floor, Shreenath Estate  
Station Road, Kota, Rajasthan - 324002  
Mobile: +91 9929110493  
E-mail: rajendra.kabra@siemens.com

**Ludhiana**  
House No. 548, FF Urban Estate  
Phase 1, Jamalpur, Chandigarh Road  
Ludhiana - 141003 Punjab  
Mobile: +91 9872131762  
E-mail: gurvinder.singh@siemens.com

**Ludhiana**  
H.No. 1235, St. No. 3/1, Sardar Nagar, Rahon Road  
Near Gurudwara Mata Bhagwanti  
Ludhiana - 141007, Punjab  
Mobile: +91 9872419990  
E-mail: ravinder.pal@siemens.com

**Madurai**  
Dhanya Block, DF-02, Vasuthara Enclave  
84, TPK Main Road, Andal Puram  
Madurai - 625003, Tamil Nadu  
Mobile: +91 9626699692  
E-mail: balaji.sakthivel@siemens.com

**Mangalore**  
Flat No. 303, Devi Dayal Residency  
Near Dominic Church, Ashok Nagar Road  
Urwa Store, Managalore - 575006  
Mobile: +91 9686488166  
E-mail: lakshimisha.k@siemens.com

**Meerut**  
110, Lotus Towers, Opp. Ansal Courtyard, Modipuram  
Meerut - 250001, Uttar Pradesh  
Mobile: +91 9889384222  
E-mail: umesh.pandey@siemens.com

**Mehsana**  
Mobile: +91 9909904993  
E-mail: piyush.thaker@siemens.com

**Mysore**  
No. 980, 4th Cross, 6th Main, Banrimantap B layout  
SS Nagar, Mysore - 570015  
Mobile: +91 9611311645  
E-mail: raashid.syed@siemens.com

**Naidupeta**  
5/94, I Floor, B Block, M.A.Nagar  
Chennai - 600052 (Near Padianalur Govt School)  
Mobile: +91 9840255185  
E-mail: r.pradeep@siemens.com

**Nashik**  
Flat No. 402, "D" Wing, Hari Shrushti  
Near Jogging Track, Opposite WNS  
Indira Nagar, Nashik - 422009  
Mobile: +91 9892292275  
E-mail: dhanaanjay.thorat@siemens.com

**Neemrana**  
F 131, Japanese Zone, Anant Raj Apartments  
Neemrana, Alwar, Rajasthan - 301705, India  
Mobile: +91 9855526122  
E-mail: kumar.manish@siemens.com

**Patna**  
A-53, 5th Floor, Krishna Apartment  
Boring Road, Patna - 800001  
Mobile: +91 9641574289  
E-mail: rajendra.mitra@siemens.com

**Pondicherry**  
Door No. 102, Second Floor, Chellan Nagar  
Main Road, Near Rainbow Nagar Park  
Pondicherry - 605011  
Mobile: +91 9786609374  
E-mail: kolappan.c@siemens.com

**Raipur**  
103-Emerald, Green Meadows, Daladal Seoni  
Mowa, Raipur, Chattisgarh - 492007  
Mobile: +91 9711007466  
E-mail: vinay.mittal@siemens.com

**Rajahmundry**  
IVY Grand Apartment, Narasanna Nagar  
Door No. 66-7-2/1A, Rajiv Gandhi Street  
Near Karanam Giri Junction, Kakinada - 533004  
Mobile: +91 9789869754  
E-mail: lakshmiikanth.ballal@siemens.com

**Rajkot**  
Pitrukrupa Street No. 5, Royal Park Society  
University Road, Near Indra Cercle, Rajkot - 360005  
Mobile: +91 8080802037  
E-mail: harsh.trivedi@siemens.com

**Ranchi**  
Raj Enclave, Flat No. 204, 2nd Floor  
Kaju Bagan (Near DAV Hehal Jr. Section)  
Piska More, P.S. Sukhdeonagar, Ranchi - 834005  
Mobile: +91 9674011440  
E-mail: sarkar.saikant@siemens.com

**Renukoot**  
Vijay Gupta Bhawan, Swami Vivekanand Colony  
Murdhawa, Renukoot - 231217  
Distt Sonebhadra, Uttar Pradesh  
Mobile: +91 9984500021  
E-mail: kumardeepak@siemens.com

**Rourkela**  
Civil Town Ship, 3rd Lane, Rourkela - 769004  
Mobile: +91 9861056581  
E-mail: ashirbad.das@siemens.com

**Rudrapur**  
Shanti Vihar Colony, Chatarpur Road  
Opposite Dr. Pandey Hospital, Rudrapur - 263153  
Distt. Udham Singh Nagar, Uttarakhand  
Mobile: +91 9839174578  
E-mail: girish.pandey@siemens.com

**Salem**  
Sri Krishna Nivasam Apartment, B2, 2nd Floor  
Vidya Ashramam Salai, Shankar Nagar, Salem - 636007  
Mobile: +91 9952389893  
E-mail: b.saravanan@siemens.com

**Siliguri**  
147 Lala Lajpat Rai Road, Haider Para  
Siliguri - 734001, West Bengal  
Mobile: +91 7278842360  
E-mail: abhishek.kar@siemens.com

**Sonepat**  
H.No. 1103, 1st Floor, Sector-14, Sonepat  
Haryana - 131001  
Mobile: +91 9855526122  
E-mail: kumar.manish@siemens.com

**Siperebbudur**  
Mobile: +91 9071161117  
E-mail: moharaj.v@siemens.com

**Surat**  
A1-504, Shradha Flats, Near Swastik Villa, Pal  
Surat - 395009  
Mobile: +91 9879110276  
E-mail: rahul.gangrade@siemens.com

**Thrissur**  
Kannanayacal House, Kurichikara PO  
Ponganamkadu, Thrissur  
Mobile: +91 9947957839  
E-mail: nobin.babu@siemens.com

**Trichy**  
Flat No.102, 'B' Block, 2nd Floor  
Vignesh Empire Apartments, Salai Road  
Woraiyur, Trichy - 620003  
Mobile: +91 8056025127  
E-mail: ponnivalavan.p@siemens.com

**Udaipur**  
A-39, First Floor, New Ahinsapuri, Fatehpura  
Udaipur, Rajasthan - 313004, India  
Mobile: +91 8696222212  
E-mail: rohit.nandan@siemens.com

**Vapi**  
Flat No. 302, 3rd Floor, Samrajya-IV  
Royal Residency, Gokul Vihar Township  
Charwada Road, Taluka - Pardi, Dist. Valsad  
Vapi - 396195  
Mobile: +91 9825147957  
E-mail: rohit.darji@siemens.com

**Vijayawada**  
Lakshmi Nilayam  
H.No. 77-135-11, 1st Floor, Dr. Colony  
Sundarayya Nagar Colony, Payakapuram  
Vijayawada - 520015, AP  
Mobile: +91 9642351144  
E-mail: venkateshward.d@siemens.com

Siemens Limited  
Smart Infrastructure  
Electrical Products  
R&D Technology Centre  
Thane Belapur Road  
Airoli Node, Navi Mumbai - 400708  
For more information contact toll free 1800 209 1800  
E-mail: lvsgr-mktg.india@siemens.com

**www.siemens.co.in**

Order No.: 111473763  
SI-EP-CC-DIPL-092021  
(This replaces SI-EP-CC-DIPL-012021  
dated 01 February 2021)

Customer Care Toll free no. 1800 209 0987  
Email: ics.india@siemens.com

Product upgradation is a continuous process. Hence, data in this pricelist is subject to change without prior notice. For the latest information, please get in touch with our Sales Offices.